

The background of the cover is a complex geometric pattern of overlapping triangles in various shades of green and yellow. The triangles are arranged in a way that creates a sense of depth and movement. In the background, there are faint, soft-focus images of clouds, suggesting a natural or outdoor setting. The overall aesthetic is modern and vibrant.

# ΑΠΛΑΥΑ

CATÁLOGO GENERAL 2022/2023 // GENERAL CATALOGUE 2022/2023

# AMAYA

Disfrutamos de más de 5 décadas de experiencia en permanente investigación y desarrollo de nuevos artículos para el deporte y para el desarrollo motor del niño, en un constante intento de adelantarnos a las necesidades infantiles y juveniles.

La elevada calidad y pureza de las materias primas europeas junto con la incorporación de los últimos desarrollos y adelantos tecnológicos en maquinaria, marcan la diferencia en calidad.

Ofrecemos una nueva generación de mezclas plásticas de máxima calidad que mejoran las prestaciones de nuestros fabricados tradicionales obteniendo una inmejorable relación calidad precio.

AMAYA SPORT garantiza que todos sus fabricados son sometidos a rigurosos controles de calidad, tanto en el análisis de las materias primas como en los procesos de producción, manipulación y embalaje.

Todos nuestros fabricados cumplen la Normativa Europea del Juguete EN-71, que contempla la seguridad en el juguete respecto a:

- Propiedades mecánicas y físicas.
- Inflamabilidad.
- Toxicidad.

Materias primas: PE, PP, EVA, PU, ABS, RIGID PVC y FLEXIBLE PVC, y termoplásticos de nueva generación. Los colorantes y las tintas son aptos para el juguete. Los artículos destinados a niños menores de 3 años cumplen la nueva normativa de la comisión europea para el año 2007 de no utilización de ftalatos.

*We enjoy more than 50 years of experience in constant investigation and development of new products for sports and for improving the psychomovement of children, trying to get ahead of the children and teenagers needs.*

*The higher quality and purity of European raw materials together with the incorporation of the latest and newest technologies in machines marks the different in quality by a long way.*

*We show a new generation of maximum quality of thermoplastic compounds which improve the performance qualities of our traditional production, obtaining an excellent relation quality - price.*

*AMAYA SPORT certify that all their products are subjected to quality control test during the manufacturing, assembly and packing process.*

*All our production complies with the requeriments of the European Toys Standard EN-71 according to:*

- Mechanical and Physical Properties.*
- Flammability.*
- Migration of certain elements.*

*Raw material: PE, PP, EVA, PU, ABS, RIGID PVC, FLEXIBLE PVC and new generation thermoplastic. Colorants and inks for toys. Our production for children younger than 3 years old complies with the european commission new laws 2007 year according to phtalates free.*



# ÍNDICE

## 1. Educación especial - *Special education*

1.1. Educación vial - <i>Road safety education</i>	3
1.2. Psicomotricidad - <i>Psychomovement.</i>	11
1.3. Piscinas sensoriales - <i>Sensorial pools.</i>	74
1.4. Pelotas y figuras de foam y foam recubierto - <i>Foam and coated foam balls and figures.</i>	77
1.5. Instrumentos musicales - <i>Musical instruments.</i>	96

## 2. Mobiliario infantil - *Children's furniture*

2.1. Suelos y vallas - <i>Floors and fences.</i>	107
2.2. Camitas y espejos - <i>Beds and mirrors.</i>	113
2.3. Muebles - <i>Furniture.</i>	115

## 3. Juegos tradicionales y deportes alternativos - *Traditional games and alternative sports.*

5.1. Juegos y deportes alternativos - <i>Alternative sports and games.</i>	136
5.2. Cometas - <i>Kites.</i>	160
5.3. Pelotas infantiles - <i>Children balls.</i>	161
5.4. Animales y figuras - <i>Animals and figures.</i>	165

## 4. Malabares y juegos de habilidad - *Juggling and hability games.*

6.1. Yo-yos	167
6.2. Diabolos	170
6.3. Malabares - <i>Juggling.</i>	173
6.4. Juegos de habilidad - <i>Hability games.</i>	175

## 5. Juegos de agua y natación - *Water games and swimming.*

	180
--	-----

## 6. Deportes, accesorios y complementos - *Sports, accesories and complements.*

3.1. Fútbol - <i>Football.</i>	190
3.2. Fútbol sala - <i>Indoor football.</i>	204
3.3. Balonmano - <i>Handball.</i>	206
3.4. Baloncesto - <i>Basketball.</i>	209
3.5. Voleibol - <i>Volleyball.</i>	218
3.6. Tenis - <i>Tennis.</i>	221
3.7. Bádminton - <i>Badminton.</i>	223
3.8. Tenis de mesa - <i>Table tennis.</i>	227
3.9. Pelota vasca.	228
3.10. Beisbol - <i>Baseball.</i>	229
3.11. Atletismo - <i>Athletics.</i>	232
3.12. Rugby.	235

## 7. Gimnasia rítmica - *Rhythmic gymnastic*

	236
--	-----

## 8. Ballet

	258
--	-----

## 8. Gimnasia - *Gymnastic*

	262
--	-----

## 9. Colchonetas - *Mats*

	268
--	-----

## 10. Accesorios y complementos - *Accesoires and complements*

	277
--	-----

## 12. Índice Alfabético - *Alphabetic index*

	282
--	-----

# 1

## EDUCACIÓN ESPECIAL:

EDUCACIÓN VIAL, PSICOMOTRICIDAD  
PISCINAS SENSORIALES, INSTRUMENTOS MUSICALES,  
ANIMALES Y FIGURAS.

## *SPECIAL EDUCATION:*

*ROAD SAFETY EDUCATION, PSICOMOVEMENT,  
SENSORIAL POOLS, MUSIC INSTRUMENTS, ANIMALS  
AND FIGURES.*





411 000 SEÑALES DE TRÁFICO CON ENGARGES A PICA - TRAFFIC PANNELS WITH STICK'S LINKS



411 000 01



411 000 02



411 000 03



411 000 04



411 000 05



411 000 06



411 000 07



411 000 12



411 000 08



411 000 09



411 000 10



411 000 11

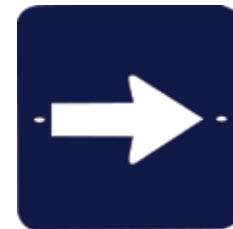

411 000 30



411 000 13



411 000 14



411 000 16

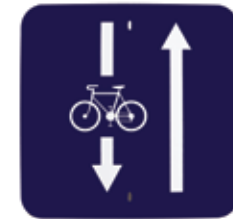

411 000 32



411 000 31



411 000 17



411 000 18



411 000 19



411 000 20



411 000 21



411 000 22



411 000 23



411 000 24



411 000 25



411 000 26



411 000 27



411 000 28



411 000 29

# SEMÁFORO TRAFFIC LIGHT

Semáforo Led con control remoto.

Semáforo de educación vial. Cambio de luces manual o automático. Varios programas con diferentes velocidades de cambio. Se puede colgar en la pared o sujetar con base y pica. El set esta compuesto por un semáforo de coches y otro de peatones. Ambos pueden trabajar sincronizados o por separado.

*Led traffic lights with remote control.*

*Road education traffic lights. Manual and automatic light change. Some different programs with different change speed. It could be hang at a wall or fixed in a stick with base. Set composed by a vehicles traffic light and a pedestrian traffic light. They could work sychronized or separately.*



## 411 050 SEMÁFORO - TRAFFIC LIGHT

Set vehículos y peatones para colgar. Pilas no incluidas: 6 pilas AA de 1,5 V. y una pila de botón CR2025.

*Set composed by a vehicle traffic light and a pedestrian traffic light. Batteries not included. 6 AA bateries 1,5 V. and a CR2025 battery.*

## 411 055 SEMÁFORO - TRAFFIC LIGHT

Set vehículos y peatones con pica y base hueca.

*Set composed by a vehicle traffic light and a pedestrian traffic light with stick and hollow base.*



Mando inalámbrico  
Wireless remote control



## TRICICLOS ESCOLARES PARA EDUCACION VIAL. SCHOOL TRICYCLE FOR ROAD EDUCATION.

Fabricados en materiales muy resistentes, en acero galvanizado y posteriormente pintado con pintura epoxi.

Ruedas de caucho con rodamientos.

*Made of very resistant galvanized steel coated with epoxy painting. Rubber wheels with bearings.*



EDUCACIÓN VIAL - ROAD SAFETY EDUCATION



### 292 000 TRICICLO ESCOLAR INDIVIDUAL

Diámetro de ruedas: Delantera 23cm. Trasera 18cm Ancho de rueda: 4,5 cm.  
Peso: 11 KG. Altura del asiento: 35 cm. Dimensiones: 86 x 56 x 66 cm.

#### SINGLE SCHOOL TRICYCLE

*Wheel's diameter: front 23 cm. Back 18 cm. Wheel's width: 4,5 cm. Weight: 11 kg. Seat height: 35 cm. Dimensions: 86 x 56 x 66 cm.*



### 292 002 TRICICLO ESCOLAR TAXI

Diámetro de ruedas: Delantera 23cm. Trasera 18 cm. Ancho de rueda: 4,5 cm.  
Peso: 14 KG. Altura de asiento: 32 cm. Dimensiones: 108 x 50 x 65 cm.

#### SCHOOL TAXI TRICYCLE

*Wheel's diameter: front 23 cm. Back 18 cm. Wheel's width: 4,5 cm. Weight: 14 kg. Seat height: 32 cm. Dimensions: 108 x 50 x 65 cm.*



### 292 004 TRICICLO ESCOLAR DOBLE

Diámetro de ruedas: delantera 23cm. Trasera 18 cm. Ancho de rueda: 4,5 cm. Peso: 15 KG. Altura del asiento: 35 cm. Dimensiones: 135 x 55 x 65 cm.

#### TWO-SEAT SCHOOL TRICYCLE

*Wheel's diameter: front 23 cm. Back 18 cm. Wheel's width: 4,5 cm. Weight: 15 kg. Seat height: 35 cm. Dimensions: 135 x 55 x 65 cm.*



### 292 006 PATINETE ESCOLAR

Diámetro de ruedas: delantera 23cm. Trasera 18 cm. Ancho de rueda: 4,5 cm. Peso: 7,5 KG. Dimensiones: 90 x 34 x 60 cm.

#### SCHOOL SCOOTER

*Wheel's diameter: front 23 cm. Back 18 cm. Wheel's width: 4,5 cm. Weight: 7,5 kg. Dimensions: 90 x 34 x 60 cm.*

## PEDAL KARTS



### 292 008 PEDAL KART PEQUEÑO

Fabricado en acero y recubierto con pintura epoxi . Ruedas de E.V.A. muy resistentes a la abrasión. Hinchables. Volante de polipropileno. Diámetro: 19.5 cm. Sillín ergonómico y granulado. 23 x 27 cm. Medidas: Largo: 91 cm. ancho: 46 cm. Alto: 55 cm. Longitud máxima pedal-asiento regulable a 4 longitudes: 50, 53.5, 56.5 y 60cm. Peso: 10kg  
Edad recomendada: de 2 a 6 años.

#### PEDAL KART - SMALL SIZE

Made of steel and coated with epoxy paint. Abrasion resistant and inflatables E.V.A wheels . Handle wheel made of polypropylene, diameter: 19.5cm. Ergonomic and granules seat size 23x27cm. Measurements: Length: 91cm. Width: 46cm. Height: 55cm. Length seat- pedal 4 adjustable lengths: 50, 53.5, 56.5 and 60cm. Weight: 10kg  
Recommended Age: 2 to 6 years

### 292 010 PEDAL KART MEDIANO

Fabricado en acero recubierto con pintura epoxi. Ruedas fabricadas en E.V.A. Muy resistentes a la abrasión. Hinchables. Volante de polipropileno. Diámetro 26 cm. Sillín ergonómico y granulado. 30 x 33 cm. Medidas: Largo 110 cm. Ancho: 59 cm. Alto: 60 cm. Longitud máxima pedal-asiento regulable a 4 longitudes. 58, 62, 65,5, 69 cm. Peso: 14.5 kg. Edad recomendada: de 6 a 12 años.

#### PEDAL KART - MEDIUM SIZE

Made of steel and coated with epoxy paint. Abrasion resistant and inflatables E.V.A wheels. Handle wheel made of polypropylene, diameter: 26cm. Ergonomic and granules seat size 30x33cm. Measurements: Length: 110cm. Width: 59cm. Height: 60cm. Length seat- pedal 4 adjustable lengths: 58,62,65.5 and 69cm. Weight: 14,5kg  
Recommended Age: 6 to 12 years



### 292 014 TURBO TWIST

Giros de 180° y 360°. Estructura con bajo centro de gravedad, fabricada en tubo de acero reforzado. Dimensiones: 960 x 370 x 1050 mm. Peso: 16,2 Kg. Rueda delantera de 50 cm. Cubierta de caucho. Ruedas traseras extra anchas de resina moldeada de perfil bajo. Freno delantero V. Control mediante joysticks para girar las ruedas traseras.

Asiento ajustable a diferentes posiciones. Recomendado de 6 a 12 años. Máximo peso 100 Kg.



Skid 180 or even twist 360 can you handle it.

Frame – low C of G (centre of gravity) steel tubular frame construction, for less drag and superior handling.

Dimensions: 960 x 370 x 1050 mm. Weight: 16,2 Kg.

Front Wheel: 20 inch Tire with freewheel. Rear Wheel: Extra wide resin moulded racing wheels with low profile. Front V brake.

Twin joysticks to control rear wheel steering crazy twists and skids. Adjustable moulded seat. From 6 to 12 years. Loading Capacity : 100 kgs.



# WAVE ROLLER



EDUCACIÓN VIAL - ROAD SAFETY EDUCATION



## 292 019 WAVE ROLLER

Estructura de acero reforzado de alta resistencia. Sistema de propulsión inteligente SPS.

Ruedas de PP + PU. Rodamientos de semiprecisión 608ZZ. Freno de mano trasero. Carga máxima 50kg.

A partir de 4 años. Colores, azul claro, rojo, rosa y azul oscuro.

*Wave roller. High resistance Steel . SPS intelligent propulsion system. PP and PU wheels 145mm. Bearing 608Z. Hand rear brake. Maximum loading 50kg. Up to 4 years old. Color: light blue, red, pink and dark blue.*





**292 090 25** Casco competición amarillo fluor-gris.



**292 090 13** Casco competición negro-gris.

## CASCO COMPETICIÓN GRAFITO ADULTO

Fabricado en Policarbonato recubierto de EPS especial para alto impacto. Materiales muy ligeros. Rejillas de ventilación diseñadas de manera especial para orientar el aire a ambos lados y conseguir la máxima aireación. 22 rejillas. Almohadillas para un mejor ajuste. Correas con buckle ajustable para mejor ajuste. Medida perímetro cabeza 58-61cm. Cumple normativa CPSC 16CFR 1203, CE EN 1078:1997.

### ADULT GRAPHITE COMPETITION HELMET

Manufactured in polycarbonate covered with special EPS for high impact. Very light materials. Ventilation grids specially designed to direct the air on both sides and provide maximum ventilation ( 22 grids ). Pads for a better fit. Straps with adjustable buckle. Head perimeter 58-61 cm. Complies with CPSC 16CFR 1203, CE EN 1078:1997 regulations.



## CASCO AJUSTABLE SKATE - BIKE - TRIKE

**292 050** Casco ajustable skate - bike- trike. 9 salidas de aire orientadas a ambos lados para mejor ventilación. Sistema de absorción de golpes. Ligero y seguro.

*Sistema de ajustado con bucle aculock-1. Adjustable helmet Skate-Bike-Trike. 9 air vent. Black EPS impact absorption liner, quick release buckle with aculock 1*

**292 050 11** ROJO/ RED talla/size S (50-52cm) **292 050 21** talla/size M (52-54cm) y **292 050 31** talla/size L (54-56cm)

**292 050 12** AZUL/ BLUE talla/size S (50-52cm) **292 050 22** talla/size M (52-54cm) y **292 050 32** talla/size L (54-56cm)

**292 050 13** FUXIA/ FUCHSIA talla/size S (50-52cm) **292 050 23** talla/size M (52-54cm)

**292 050 14** AMARILLO/ YELLOW talla/size S (50-52cm) **292 050 24** talla/size M (52-54cm) y **292 050 34** talla/size L (54-56cm)





## CASCO COMPETICIÓN AJUSTABLE SPORT SKATE DISEÑO

**292 070** Casco competición ajustable sport skate diseño. 11 salidas de aire con sistema especial de ventilación. Concha recubierta de ABS con sistema de absorción de golpes. Ligero y seguro. Sistema de ajustado con bucle aculock-1. - *Competition with design adjustable helmet sport skate. 11 air vent with cooling system. ABS shell . EPS impact absorption liner, quick release buckle with aculock 1*

**292 070 11** Camuflaje verde talla S ( 53-55cm)- *Green Camouflage. Size S(53-55cm)*    **292 070 21** talla M ( 55-57cm) - *Size M ( 55-57cm)*

**292 070 12** Camuflaje tierra talla S ( 53-55cm) - *Ground Camouflage. Size S(53-55cm)*    **292 070 22** talla M ( 55-57cm) - *Size M ( 55-57cm)*

**292 070 13** Gráfico negro talla S ( 53-55cm) - *Black graphic. Size S( 53-55cm)*    **292 070 23** talla M ( 55-57cm) - *Size M ( 55-57cm)*

**292 070 14** Gráfico fuxia talla S ( 53-55cm) - *Fuchsia graphic. Size S(53-55cm)*    **292 070 24** talla M ( 55-57cm) - *Size M ( 55-57cm)*



## CASCO COMPETICIÓN SPORT SKATE

**292 080** Casco competición ajustable sport skate. 11 salidas de aire con sistema especial de ventilación. Concha recubierta de ABS con sistema de absorción de golpes. Ligero y seguro. Sistema de ajustado con bucle aculock-1.

*Competition adjustable helmet sport skate. 11 air vent with cooling system. ABS shell . EPS impact absorption liner, quick release buckle with aculock 1*

**292 080 11** ROJO/ *RED* talla/size S ( 53-55cm)    **292 080 21** talla/size M ( 55-57cm)

**292 080 12** AZUL/ *BLUE* talla/size S ( 53-55cm)    **292 080 22** talla/size M ( 55-57cm)

**292 080 13** AMARILLO/ *YELLOW* talla/size S ( 53-55cm)    **292 080 23** talla/size M ( 55-57cm)

**292 080 24** NEGRO/ *BLACK* Talla/size M ( 55-57cm)    **292 080 34** NEGRO/ *BLACK* Talla/size L



## CASCO INFANTIL SKATE - BIKE - TRIKE

**292 060** Casco infantil ajustable SKATE- BIKE-TRIKE. 5 salidas de aire. Sistema de absorción de golpes. Ligero y seguro. Sistema de ajustado con bucle aculock-1. *Kids helmet Skate-Bike-Trike. Adjustable. 5 air vent. Black EPS impact absorption liner, quick release buckle with aculock 1*

**292 060 11** VERDE/ *GREEN* talla/size S( 48-50cm)

**292 060 12** VERDE/ *GREEN* talla/size M (50-52cm)

**292 060 21** ROSA/ *PINK* talla/size S (48-50cm)

**292 060 22** ROSA/ *PINK* talla/sizeM (50-52cm)

290 729 00

## JUEGO SENIOR RODILLERAS, CODERAS, PROTECTORES

Juego SENIOR de rodilleras, coderas y protectores. Color Negro.

Fabricadas en tela y polipropileno. . Talla L de 14 a 17 años

SENIOR KNEEPADS, ELBOW AND HAND PROTECTORS BLACK size L

Made in fabric and PP. Size L 14 - 17 years old. Black color.



290 728 01

## JUEGO INFANTIL RODILLERAS, CODERAS, PROTECTORES

Juego infantil de rodilleras, coderas y protectores. Color Rosa.

Fabricadas en tela y polipropileno. . Talla S de 3 a 8 años.

CHILDREN KNEEPADS, ELBOW AND HAND PROTECTORS PINK size S

Made in fabric and PP. Size S 3 - 8 years old. Pink color

290 728 02

## JUEGO INFANTIL RODILLERAS, CODERAS, PROTECTORES

Juego infantil de rodilleras, coderas y protectores. Color Azul.

Fabricadas en tela y polipropileno. . Talla S de 3 a 8 años.

CHILDREN KNEEPADS, ELBOW AND HAND PROTECTORS BLUE size S

Made in fabric and PP. Size S 3 - 8 years old. Blue color



290 727 01

## JUEGO INFANTIL RODILLERAS, CODERAS, PROTECTORES

Juego infantil de rodilleras, coderas y protectores. Color Negro.

Fabricadas en tela y polipropileno. . Talla S de 3 a 8 años.

CHILDREN KNEEPADS, ELBOW AND HAND PROTECTORS BLACK size S

Made in fabric and PP. Size S 3 - 8 years old. Black color

290 727 02

## JUEGO INFANTIL RODILLERAS, CODERAS, PROTECTORES

Juego infantil de rodilleras, coderas y protectores. Color Negro.

Fabricadas en tela y polipropileno. . Talla M de 8 a 14 años.

CHILDREN KNEEPADS, ELBOW AND HAND PROTECTORS BLACK size M

Made in fabric and PP. Size S 8 - 14 years old. Black color.

290 731 00

## JUEGO ADULTO RODILLERAS, CODERAS Y PROTECTORES

Juego para adulto de rodilleras, coderas y protectores. Color Negro

Fabricada en Nylon 420D y polipropileno.

ADULT KNEEPADS, ELBOW AND HAND PROTECTORS BLACK size Adult

Made in 420D Nylon and PP. Size adult. Black color.





# BALANCE BOARD TORTUGA



## 412 300 BALANCE BOARD TORTUGA

El balance board más completo y funcional, que permite balancearse de lado a lado de forma segura y controlada gracias a los hexágonos antideslizantes de la base. Proporciona un movimiento más suave y fácil de controlar. Los niños pueden estar de pie o sentados en la tabla mientras desarrollan la función motora y mejoran el equilibrio. Con asas para agarre.

Permite realizar giros y movimientos laterales, gracias a los pivotes de la base donde el niño se apoya al cambiar el peso del cuerpo. Ejercita la musculatura, el equilibrio mecánico y la estimulación propioceptiva de los niños.

Base de goma suave para evitar daño en el suelo.

Desarrollado por el prestigioso estudio de diseño GAUZAK.

Peso de la tabla: 1,8 kilos. Carga máxima soportada: 60 kg.

Medidas: largo: 608 mm. Ancho: 304 mm. Alto: 160 mm.

## TURTLE BALANCE BOARD

*The most complete and functional balance board, which allows you to swing from side to side safely thanks to the non-slip hexagons of the base. It provides a smoother and easier to control movement. Children can stand or sit on the table while they develop motor function and improve balance. With handles to grab.*

*It allows to make turns and lateral movements, thanks to the lateral pivots of the base where the child rests while changing the weight of the body. Exercises the muscles, mechanical balance and proprioceptive stimulation of children.*

*Soft rubber base to prevent damage on the ground.*

*Developed by the prestigious GAUZAK design studio.*

*Weight of the table: 1.8 kilos. Maximum load: 60 kg.*

*Dimensions: length: 608 mm. Width: 304 mm. Height: 160 mm.*



412 300 11



412 300 10



412 300 06

## 61062100 ROCKET

Plataforma motriz para ejercicios de deslizamientos. Con superficie acolchada. Ruedas de seguridad.

Incluye cuerda con asa acolchada para poder ser dirigida y cuerda de conexión con otros rockets.

Medidas 60 x 36 x 10,5 cm.

61062100 Rocket

*Platform for sliding exercises. With padded surface. Security wheels.*

*Includes rope with padded handle allowing to be leaded and connection cord allowing connection with other rockets.*

*Measures 60 x 36 x 10.5 cm.*



Detalle rueda de seguridad.  
Security wheel detail.







BEAN BAGS



**410 385 SAQUITOS LETRAS BEAN BAGS**

Set de 26 unidades. Medidas: 11,5 x 11,5 cm. Peso: 70 gr. cada saquito.

**LETTERS BEAN BAGS**

Set with 26 units. Meassure: 11,5 x 11,5 cm. Weight: 70 g.



**410 386 SAQUITOS NÚMEROS BEAN BAGS**

Set de 10 unidades. Medidas: 11,5 x 11,5 cm. En castellano por una cara e inglés por la otra. Peso: 70 gr. cada saquito.

**NUMBERS BEAN BAGS**

Set with 10 units. Meassure: 11,5 x 11,5 cm. Weight: 70 g. One face in spanish language, another in english.



**410 387 SAQUITOS COLORES BEAN BAGS**

Set de 8 unidades. Medidas: 11,5 x 11,5 cm. En castellano por una cara e inglés por la otra. Peso: 70 gr. cada saquito.

**COLOURS BEAN BAGS**

Set with 8 units. Meassure: 11,5 x 11,5 cm. Weight: 70 g. One face in spanish language, another in english.



**410 350 CÍRCULOS DE CAUCHO**  
Set de 6 piezas. Ø 229 mm.  
**ROUND RUBBER SPOT MARKERS**  
Set 6 pieces. Ø 229 mm.



**410 355 CUADRADOS DE CAUCHO**  
230 x 230 mm. Set de 6 piezas.  
**SQUARE RUBBER SPOT MARKERS**  
230 x 230 mm. Set 6 pieces.



**410 360 ESTRELLAS DE CAUCHO**  
Estrellas de caucho. Set de 6 piezas.  
Medidas: 250 x 250 mm.  
**STAR RUBBER SPOT MARKERS**  
Set 6 pieces.



**410 376 TIRAS RECTAS DE CAUCHO**  
Set de 12 piezas. Medidas: 340 mm. longitud.  
**STRAIGHT RUBBER SPOT MARKERS.** Set 12  
pieces. Measure: 340 mm. length.

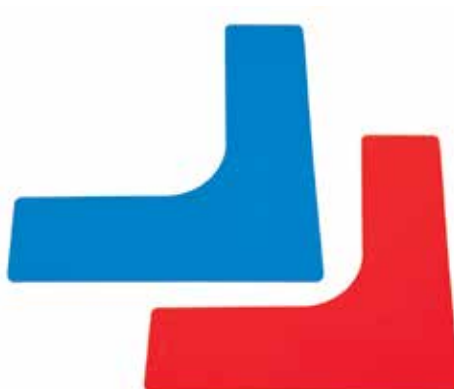

**410 375 ESQUINAS DE CAUCHO**  
Set de 4 piezas.  
Medidas: 250 x 250 mm.  
**CORNER RUBBER SPOT MARKERS**  
Set 4 pieces. Size: 250 x 250 mm.

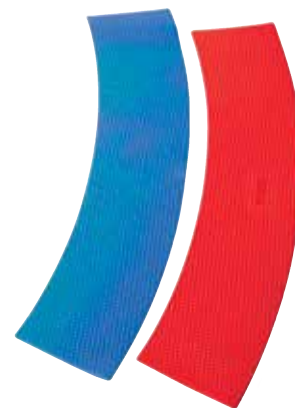

**410 377 CURVAS DE CAUCHO**  
Curvas de caucho. Set de 10 piezas.  
Medidas: 365 mm. longitud.  
**CURVE RUBBER SPOT MARKERS**  
Set 10 pieces.  
Measure: 365 mm. length.





**410 370 PIES DE CAUCHO**  
Set de 20 piezas. Longitud: 230 mm.  
**FOOT SHAPE RUBBER SPOT MARKERS**  
Set 20 pieces.



**410 365 MANOS DE CAUCHO**  
Set de 20 piezas.  
Medidas: 195 x 195 mm.  
**HAND SHAPE RUBBER SPOT MARKERS**  
Set 20 pieces.

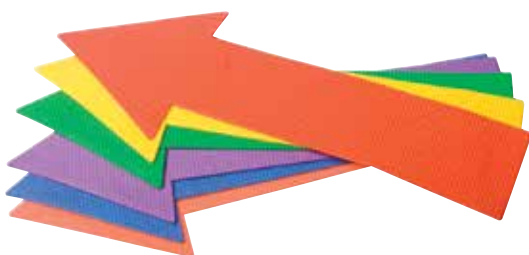

**410 378 FLECHAS DE CAUCHO RECTAS**  
Set de 6 piezas. Medidas: 360 mm. longitud.  
**ARROW SHAPE RUBBER SPOT MARKERS**  
Set 6 pieces Measure: 360 mm. length.



**410 379 FLECHAS DE CAUCHO CURVAS**  
Set de 6 piezas.  
**CORNER SHAPE RUBBER SPOT MARKERS**  
Set 6 pieces.



**410 380 NÚMEROS DE CAUCHO DEL 0 AL 9.**  
Set de 10 piezas. Medidas: Ø 220 mm.  
**0-9 NUMBERS RUBBER SPOT MARKERS**  
Set 10 pieces. Ø 220 mm.

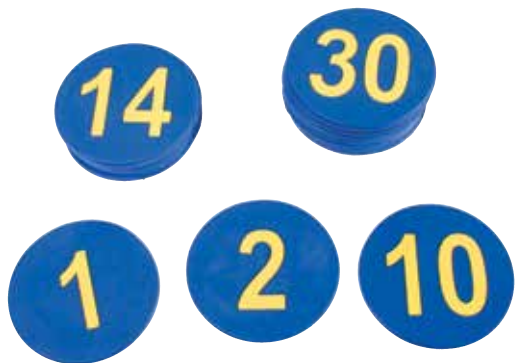

**410 381 NÚMEROS DE CAUCHO DEL 1 AL 30.**  
Set de 30 piezas. Medidas: Ø 125 mm.  
**1-30 NUMBERS RUBBER SPOT MARKERS**  
Set 30 pieces. Ø 125 mm.





## 411 298 00 LUMMIC - LUCES DE REACCIÓN/ REACTION LIGHTS

ENTRENA, JUEGA, APRENDE Y DIVIÉRTETE

Un sistema de entrenamiento basado en la reacción luminosa y auditiva. Permite desarrollar la velocidad, reflejos, capacidad de reacción y memoria. No solo en el ámbito deportivo, sino también para niños y personas mayores. Pack de 4 unidades + accesorios. LUMMIC es tanto para deportistas, como para niños, como para personas mayores. Tiene un sinfín de posibilidades y modos que te permiten evolucionar y mejorar en el ámbito que selecciones. LUMMIC está pensado para 4 públicos diferentes, pero lo mejor de todo es que para cualquiera de ellos lo que necesitas es lo mismo: Pack Lummic + App Lummic Oficial. Mide tus resultados y progresa continuamente Usa la APP, no sólo para programar tus entrenamientos y juegos, sino para tener el completo control de los resultados y progreso que estás llevando hasta ahora. Analiza tus datos y ve incrementando el nivel para conseguir un continuo progreso. APP disponible para iPhone y Android.

El Pack Incluye: Lummic (x4). Correas de sujeción al cuerpo (x4). Ventosas de fijación (8x4). Imanes de fijación (x4). Enganches a pica (25mm) (x4). 1 bolsa transparente (x1).Cable USB de carga (x1). Libro de instrucciones + APP Oficial.

**TRAIN, PLAY, LEARN AND ENJOY.**

*A training system based on luminous and auditory reaction. Develop speed, reflexes, reaction capacity and memory. Lummic is not only for athletes, you can use it also with childs and elderly people. Provides many possibilities and modes, allowing to evolve and improve in the choisen field. Lummic is developed for 4 different groups, but for everyone you need the same elements : Pack Lummic (4 lummics + accesories) + Official Lummic App. Measure your results and progress continuously. Use the App not only to schedule your trainings and games, also to have the full control of the results and progress that you are having along the use. Check your data and increase your level to reach your best progress. APP available for iPhone and Android.*

Lummic pack include: Lummic (x4). Body straps (x4). Suction cups (x4). Fastening magnets (x4). Stick links 25mm (x4). Carry bag (x1). User manual and Official APP.







Juegos cognitivos  
*Cognitive games*

Ejercicios de memoria  
*Memory exercises*

PSICOMOTRICIDAD - PSYCOMOVEMENT

**41129801 LUMMIC  
LUCES DE REACCIÓN - INDIVIDUAL**

ENTRENA, JUEGA, APRENDE Y DIVIÉRTETE  
Si ya tienes el Pack Lummic y quieres añadir algún elemento más,  
lo puedes adquirir de forma individual.  
1 unidad + accesorios. Incluye:

- Lummic (x1).
- Correa de sujeción al cuerpo (x1).
- Ventosa de fijación (x1).
- Imán de fijación y agarre a cono (x1).
- Eganche a pica (25mm) (x1).

*Train, play, learn and enjoy*  
*If you already have the Lummic Pack and want to add some more*  
*element, you can purchase it individually. 1 unit + accessories in-*  
*cludes:*

- 1 Lummic
- 1 Body strap
- 1 Fixing suction cup
- 1 Magnet for fixing and gripping the cone
- 1 Fixing Hook for a stick diameter 25 mm.



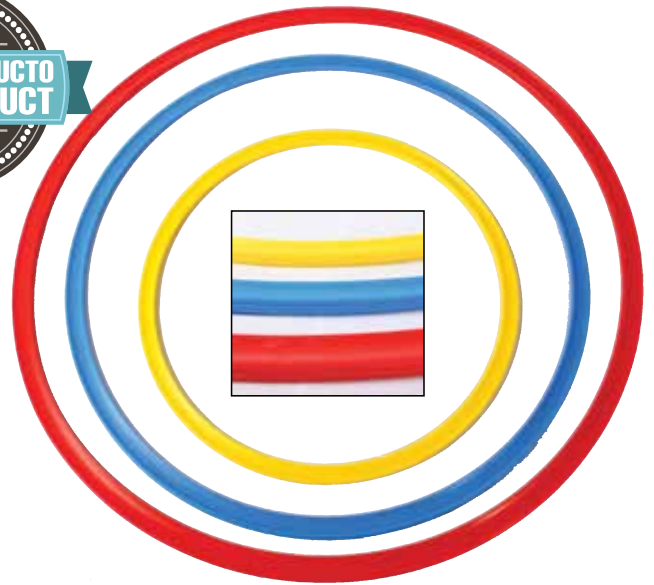
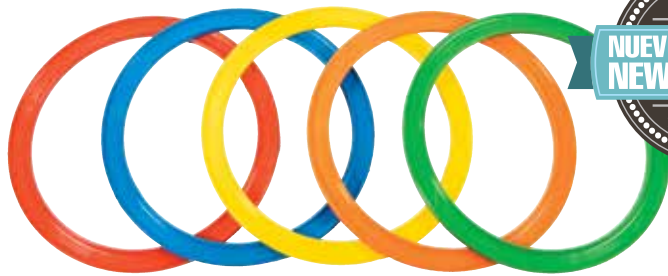

- 411 104 03 ARO/ HOOP 20 cm. Amarillo/ Yellow
- 411 104 07 ARO/ HOOP 20 cm. Rojo/ Red
- 411 104 08 ARO/ HOOP 20 cm. Naranja/ Orange
- 411 104 09 ARO/ HOOP 20 cm. Verde/ Green
- 411 104 11 ARO/ HOOP 20 cm. Azul/ Blue

- 411 100 Set aros psicomotricidad: 1 de Ø 61 cm., 1 de Ø 50 cm. y 1 de Ø 36 cm.
- Set 3 psycovement hoop: 1 u. Ø 61 cm., 1 u. Ø 50 cm., 1 u. Ø 36 cm.
- 411 101 Aro plano Ø 61 cm. - Flat hoop Ø 61 cm
- 411 102 Aro plano Ø 50 cm. - Flat hoop Ø 50 cm.
- 411 103 Aro plano Ø 36 cm. - Flat hoop Ø 36 cm.

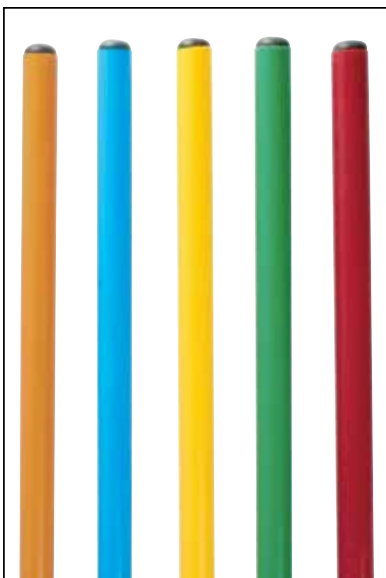

432 506 Soporte para conos y picas.  
Support for cone and stick.



410 900 Engarce fijo de picas. Bolsa de 12 unidades.  
Linking for sticks. Bag with 12 u.

- 410 400 Pica de 35 cm. - Stick 35 cm.
- 410 500 Pica de 70 cm. - Stick 70 cm.
- 410 600 Pica de 100 cm. - Stick 100 cm.
- 410 700 Pica de 120 cm. - Stick 120 cm.
- 410 800 Pica de 160 cm. - Stick 160 cm.



410 901 Engarce universal. Bolsa de 6 unidades.  
Multi-linking. Bag with 6 u.



- 422 100 Cuerda psicomotricidad 2,5 m. - Ropes 2,5 m. long
- 422 200 Cuerda psicomotricidad 10 m. - Ropes 10 m. long



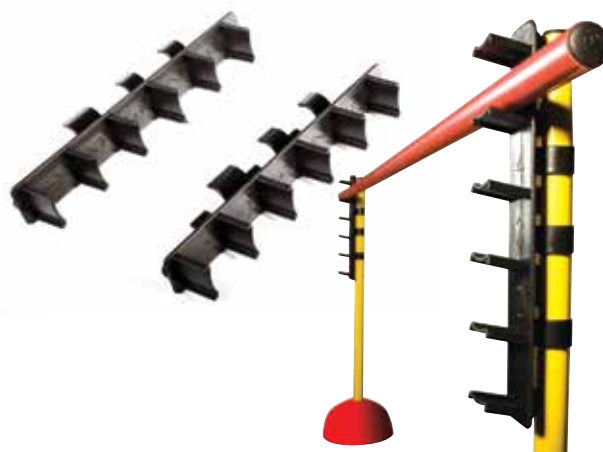
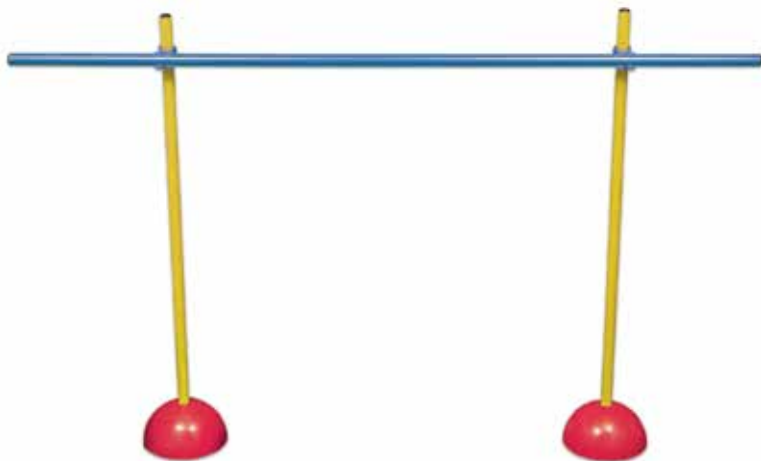

**432 503 KIT ENTRENAMIENTO BASE MACIZA:** 2 bases macizas de 1,8 kg. 3 picas de 1,60 m y 2 engarces.

*Training kit: 2 solid bases 1,8 kg. 3 sticks 1,60 m and 2 links for stick.*

**432 507 KIT ENTRENAMIENTO BASE HUECA:** 2 bases huecas rellenas de arena, 3 picas de 1,60 m y 2 engarces.

*Training kit 2: 2 empty sand filled bases , 3 sticks 1,60 m and 2 links for stick.*

**642 050** Pieza para pica regulable en altura. 6 niveles.  
*Piece for sticks adjustable high. 6 levels.*



**642 045 SET OBSTÁCULOS JUMP**  
Compuesto por 2 conos, 2 soportes y una pica.  
*Set obstacle jump.*  
*Composed by 2 cones, 2 supports and a stick.*



**432 501 CONO SEÑALIZACIÓN PE.** de 32 cm.  
*Cones 32 cm.*



**CONO DE 42 Y 52 CM** fabricado en P.E. nuevo y flexible. Recupera su forma tras la deformación. - *Cone 42 and 52cm made in flexible P.E. Recover its shape after deformation.*

**432 493** Cono 42 cm. - *Cone 42 cm.*

**432 496** Cono 52 cm. - *Cone 52 cm.*



**432 500 CONO DE 24 CM.** - *Cone 24 cm.*



**432 504 BASE MACIZA DE 1,8 KG.**  
Para kit de entrenamiento.  
*Solid base 1,8 kg.*

**432 510 BASE HUECA RELLENABLE**  
Con base antideslizante. Ø 24 cm  
*Hollow fillable base with nonslip base. Ø 24 cm.*



**432 505 CONO** gran flexibilidad, set de 48 unidades.  
*Flexible cone. Set 48 units.*



**432 502 CONO REDONDO**  
set de 40 unidades.  
*Round cone. Set 40 units.*

## ESCALERAS DE BRAQUIACIÓN

Escaleras de braquiación metálicas. Fabricadas acero galvanizado y recubierto con pintura epoxi. Apto para exteriores. Con regulación de altura manual, adaptando la medida a las necesidades de los niños. Barras fijas con separación cada 30 cm, A parte incluye 10 barras extraíbles para colocar en medio de las fijas, dando una separación de 15 cm si se desea. Máxima altura de la escalera 2m.

*Made of galvanized steel and coated with epoxy paint. Suitable for outdoor. Manual height adjustable, adapting the measure to the children. Bars every 30 cm. Include 10 extra bars for giving a separation of 15 cm if desired. Maximum ladder height 2 m.*

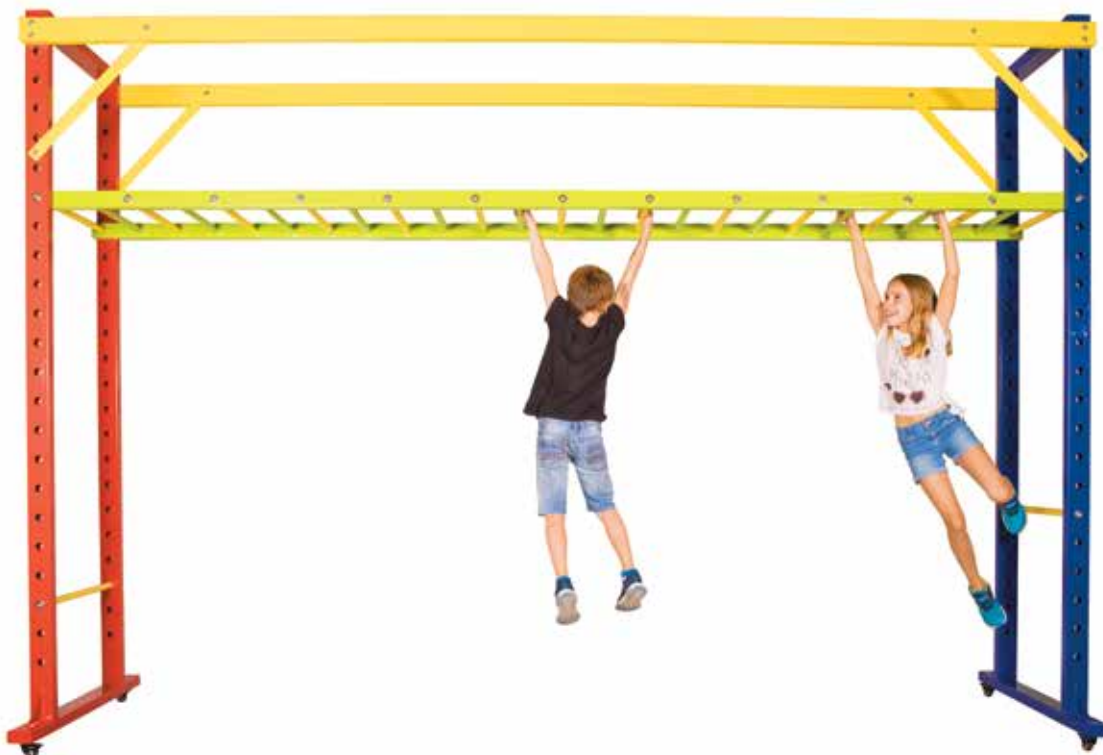

### 300 045 ESCALERA DE BRAQUIACIÓN SUELO

Con ruedas extraíbles y con bloqueo, para un fácil transporte. Ruedas desmontables para anclaje al suelo. Longitud: 3,5 metros. Ancho 1 metro, Alto 2,2 metros. Ancho de barras 50 cm. Diámetro de barras 2,5 cm.

*With removable wheels for easy transport and for floor anchoring. Length: 3.5 meters. Width 1 meter Height: 2.2 meters. Bar: width 50 cm . 2.5 cm diameter.*

### 300 040 ESCALERA DE BRAQUIACIÓN PARED

Con sistema de anclaje a pared. Regulable en altura. Longitud: 3,5 metros. Ancho de barras 50 cm. Diámetro de barras 2,5 cm. Ancho total 77cm.

*With wall anchoring system. Height adjustable. Length: 3.5 meters. Width: 77cm  
Bar width 50 cm . 2.5 cm diameter*



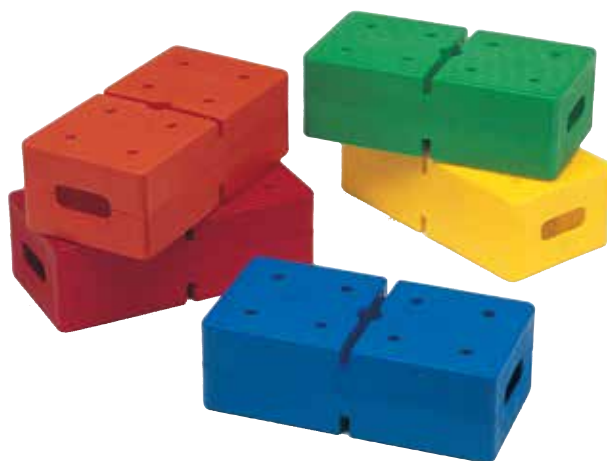

**410 100 LADRILLO REFORZADO**

De 31 x 15 x 10 cm.  
Bricks 31 x 15 x 10 cm.



**410 300 VENTOSA SUJECIÓN LADRILLO**

Bolsa de 12 unidades.  
Sucker for bricks. Bag with 12 pcs.



**410 200 PIVOTES UNIÓN LADRILLOS**

Bolsa de 12 unidades.  
Pivots for bricks union. Bag with 12 pcs.

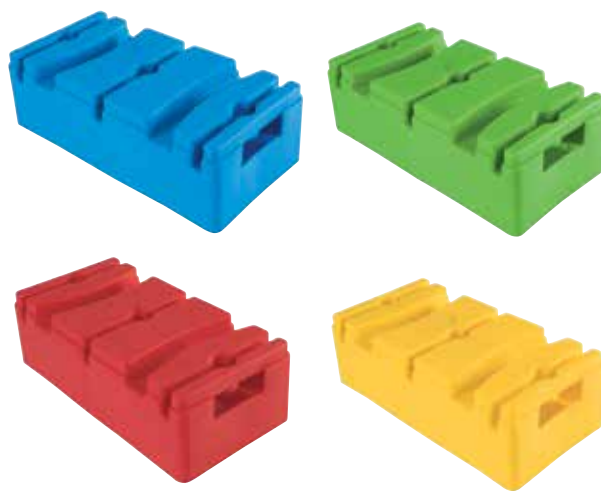

**410 105 LADRILLO UNIVERSAL DE 30 X 15 CM.**

Con agujeros y ranuras para integrar aros y picas de psicomotricidad.  
Universal Bricks 30 x 15. Holes and slots for sticks and hoops.



**410 301 BLOQUES DE CONSTRUCCIÓN**

Set de 32 piezas de 30 x 15 x 20 cm. y 8 piezas de 15 x 15 x 20 cm.  
Construction blocks, set of 32 pieces 30 x 15 x 20 cm. and 8 pieces 15 x 15 x 20 cm.



**ARQUITECTURAS SOFT**

Bloques de construcción soft. Fabricados en material no tóxico. Muy suaves y fáciles de acoplar. Cantos redondeados. Especial para los más pequeños.

**SOFT ARCHITECTURES**

Soft construction bricks. Made of non toxic material. Very soft and easy to link up. Rounded corners. Special for youngest.

411 736 Arquitecturas soft 25 piezas. - Soft architecture 25 pieces.

PSICOMOTRICIDAD - PSYCOMOVEMENT

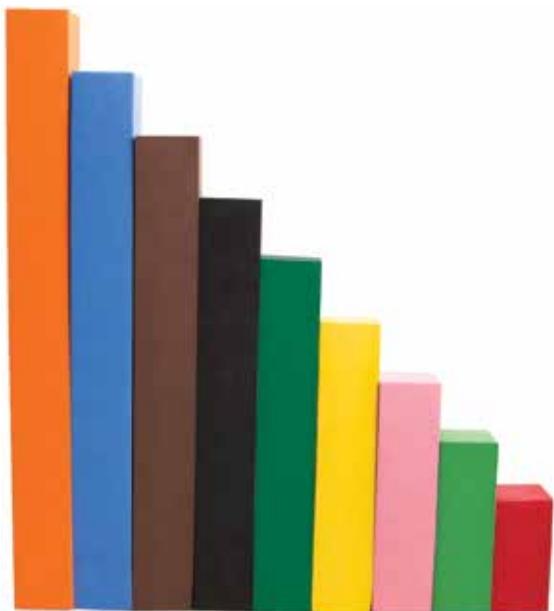

**411 250 REGLETAS MATEMÁTICAS SOFT.**

Regletas matemáticas fabricadas en material suave de EVA. Para realizar equivalencias numéricas y la representación de las operaciones básicas. Su tamaño y colores facilitan la demostración ante los alumnos, y el divertido uso y manipulación. Sección cuadrada de 45 x 45 mm. Juego compuesto por: 1 naranja (nº10) 45 cm, 1 azul (nº9) 40,5 cm, 1 marrón (nº8) 36 cm, 1 negro (nº7) 31,5 cm, 1 verde oscuro (nº6) 27 cm, 2 amarillos (nº5) 22,5 cm, 2 rosas (nº4) 18 cm, 3 verde claro (nº3) 13,5 cm, 5 rojos (nº2) 9 cm y 12 blancos (nº1) 4,5 cm. No tóxico e ignífugo. Cumple la normativa EN-71.

**SOFT MATHEMATICS STICKS**

Mathematic sticks made of soft E.V.A. For learning mathematics equivalences in easy and funny way. Sticks in big and safe material. Game composed by: 1 orange stick (n.10) 45 cm, 1 blue (n.9) 40,5 cm, 1 brown (n.8) 36 cm, 1 black (n.7) 31,5 cm, 1 dark green (n.6) 27 cm, 2 yellow (n.5) 22,5 cm, 2 pink (n.4) 18 cm, 3 soft green (n.3) 13,5 cm, 5 red (n.2) 9 cm. and 12 white (n.1) 4,5 cm.





**411 738 ARQUITECTURAS PIRAMIDALES**

Arquitecturas piramidales. Juego de construcción compuesto por 30 piezas de diferentes colores y tamaños. Posibilidad de realizar infinidad de figuras. Juego muy intuitivo, apilar, ordenar, combinar colores, realizar modelos existentes, crear nuevos modelos. Múltiples beneficios para el desarrollo de la creatividad y de la psicomotricidad espacial. Fabricada en ABS.

*Construction game including 30 pieces in different shapes and colors. Very intuitive game lets the children to make countless figures, leaving them absolute freedom and creativity. By stacking, sorting, balancing and combining colors the children learn to develop their motor skills and sense of space. Made in ABS.*

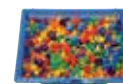

**411 733 RUEDAS ENGARZABLES**

40 unidades. Diámetro 4,3 cm.  
*Hooked Wheels. 40 units. Diameter 4,3 cm.*

**411 740 MOSAICO CUADRADOS**

Contiene 140 piezas triangulares y 350 cuadradas. Con hojas de ejemplos para componer.  
*Square mosaic. Contains 140 triangular pieces and 350 square pieces. Include designs for learning.*

**411 742 MOSAICO CÍRCULOS**

Contiene 50 círculos grandes, 60 círculos medianos y 250 círculos pequeños. Con hojas de ejemplos para componer.  
*Circle mosaic. Contains 50 big circles, 60 medium circles and 250 small circles. Include designs for learning.*



**411 743 - MOSAICO GRANDE**

Mosaico para niños. Círculos de gran tamaño. Colores variados. Fáciles de insertar. Incluye 12 plantillas de ejemplo. 48 círculos de colores+1 tabla +1 caja contenedora + 6 láminas con 12 plantillas.

**CHILDREN BIG MOSAIC**

*Large circles in assorted colours. Easy to fit. Contains 48 circles, 1 board, 1 box and 12 templates.*



**411 300 ANILLAS ENGARZABLES**

Medidas: 8 x 3,5 cm. - Linkable rings. Measures: 8 x 3,5 cm.



**411 400 BOLAS ENGARZABLES Ø 30 mm.** Set de 100 unidades.  
Linkable balls Ø 30 mm. 100 units set.

**411 500 BOLAS ENGARZABLES Ø 25 mm.** - Linkable balls Ø 25 mm.  
100 units set.

**411 600 BOLAS ENGARZABLES Ø 20 mm.** Set de 200 unidades.-  
Linkable balls Ø 20 mm 200 units set..

**411 700 BOLAS ENGARZABLES Ø 15 mm.** Set de 200 unidades.-  
Linkable balls Ø 15 mm. 200 units set.



**411735 SET FIGURAS ENGARZABLES SOFT**

Figuras engarzables fabricadas en material blando muy seguro. Se encajan con facilidad por diferentes posiciones. Ayuda a desarrollar la creatividad, coordinación y motricidad fina. Set compuesto por 64 piezas de diferentes colores.

Set Soft linkables figures

Figures made of soft material socketed very sure. It fits easily in different positions. Helps developing creativity, coordination and fine motor skills.

Set composed by 64 pieces of different colors.





**411 305 CADENAS ENGARZABLES PLANAS**

Set de 80 piezas.

*Hooked flat chains. Set 80 pieces.*



**411 310 ANILLAS ENGARZABLES GEOMÉTRICAS**

Set de 60 piezas.

*Hooked geometric chains. Set 60 pieces.*



**411 705 MIX DE FIGURAS ENGARZABLES**

Set de 180 piezas.

*Mix of hooked figures. Set 180 pieces.*



**411 730 PIEZAS DE CONSTRUCCIÓN**

Set de 40 piezas.

*Construction pieces. Set 40 pieces.*







**411 715 TORNILLOS Y TUERCAS**

Set de 32 piezas.

Screws and nuts. Set 32 pieces.



**411 720 ARQUITECTUA PLANA**

Set de 58 piezas.

Flat architecture. Set 58 pieces.



**411 725 FIGURAS PARA COSER**

Set de 24 piezas.

Figures to sew. Set 24 pieces.



**411 710 MINI ARQUITECTURA**

Set de 193 piezas. Producto para mayores de 6 años. - Mini architecture. Set of 193 pieces. Recommended for up to 6 years old.



# ARCHITECTURE TUBES

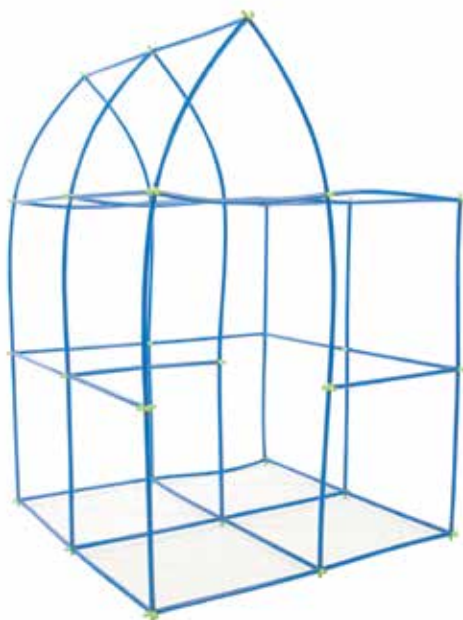
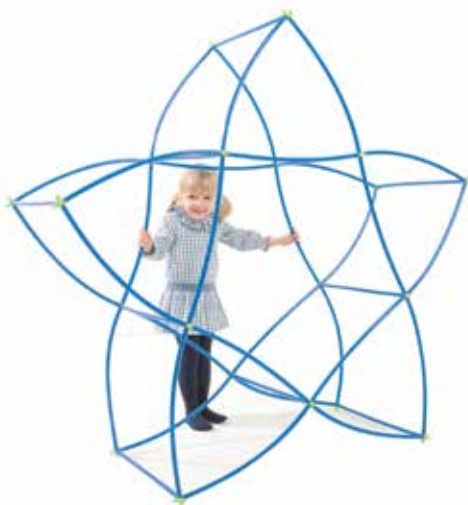

PSICOMOTRICIDAD - PSYCOMOEMENT



## 41174505 - ARQUITECTURA TUBOS

Un ingenioso juego de construcción muy fácil de montar. Desarrolla la imaginación de los más pequeños. Infinitas posibilidades de construcción en 3D. Tubos flexibles fáciles de unir mediante los conectores de plástico. Materiales no tóxicos. Incluye manual de instrucciones con ejemplos, 150 tubos flexibles y 60 conectores.

## ARCHITECTURE TUBES

3D Construction creative toy, easy to assembly. Develop imagination and creativity of children. Flexible straws and connectors with easy-to-handle connector system. Contains: 150 assorted straws, 60 connectors and 1 manual with examples.

# TUBOS ENGARZABLES / LINKABLE TUBES



## 411 745 - TUBOS ENGARZABLES

Un ingenioso juego de construcción muy fácil de montar. Desarrolla la imaginación de los más pequeños. Infinitas posibilidades de construcción en 3D. Tubos flexibles fáciles de unir mediante los conectores de plástico. Materiales no tóxicos. Incluye manual de instrucciones con ejemplos, 230 tubos flexibles diferentes colores y 170 conectores.

## LINKABLE TUBES

3D Construction creative toy, easy to assembly. Develop imagination and creativity of children. Flexible straws and connectors with easy-to-handle connector system. Contains: 230 assorted straws, 170 connectors and 1 manual with examples. Non-toxic.



# MAGBARS

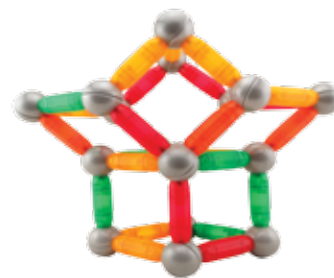
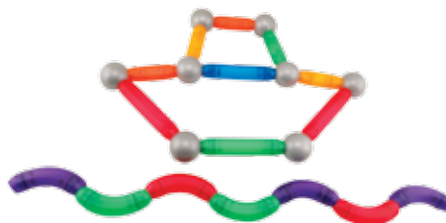

## MAGBARS

Magbars: Innovador juguete magnético que ofrece a los más pequeños una forma divertida de explorar formas y crear un sin fin de construcciones. Este juguete magnético fomenta en los niños el desarrollo de la creatividad y de conceptos como la ciencia, el magnetismo y la conciencia espacial mientras se divierten usando las piezas para construir torres, puentes y otras creaciones.

La guía de colores sugiere numerosos modelos de pequeñas y grandes construcciones. Las barras magnéticas se conectan fácilmente y se pueden utilizar para hacer composiciones en 2D y 3D. Es un instrumento increíble para desarrollar la solución de problemas, el pensamiento lógico y la concentración, proporcionando horas de divertidos desafíos para los niños.

*Magbars: The innovative magnetic toy that gives children a fun way to explore shapes and create endless building possibilities. This magnetic toy will encourage young children to develop creativity and science concepts such as magnetism, shapes and patterns in young children while they have fun using the pieces to construct towers, bridges and other creations.*

*The colourful guide gives many suggestions for small and large constructions. The magnetic bars connect easily and can be used to make both 2D and 3D shapes and it is an amazing way to encourage the development of problem solving, logical thinking and concentration, providing hours of fun challenges for the kids.*

411 290 00 Barras magnéticas 30 piezas. - 30 pieces

411 292 00 Barras magnéticas 60 piezas - 60 pieces

# MAGSMARTERS

CONSTRUCCIONES MAGNÉTICAS INTELIGENTES

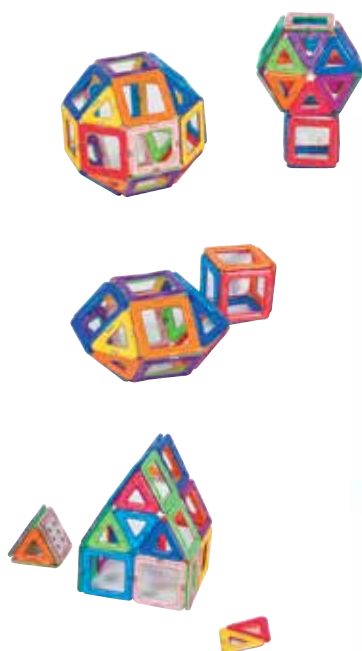

## MAGSMARTERS

Explora y experimenta la creación de distintas figuras geométricas con la ayuda de triángulos y cuadrados. Siente la fuerza del magnetismo y disfruta de incontables horas explorando los Magformers y sus posibilidades.

Experience the creation of different geometric figures with the help of triangles and squares. Feel the power of magnetism and enjoy countless hours exploring the Magformers and its possibilities.

411 280 Magmarters 30 piezas. - 30 pieces

411 282 Magmarters 60 piezas. - 60 pieces

411 284 Magmarters 90 piezas. - 90 pieces



PSICOMOTRICIDAD - PSYCOMOVEMENT

# MAGTILES

## MAGTILES

Es un divertido juego de construcción con formas planas que sumerge al niño (y a algún adulto creativo) en la creación de formas 2D y 3D. Seguro que pondrá una sonrisa en la gente que aprecia los juguetes creativos y el aprendizaje activo.

*Is a fun "shape building" set utilizing embedded magnets that immerses children (and creative adults) into crafting 2D and 3D art sure to put a smile on those who appreciate creative, active learning.*

41126932 Magtiles 32 piezas de construcción. - *Magtiles 32 Building pieces.*

41126960 Magtiles 60 piezas de construcción. *Magtiles 60 Building pieces.*

41126999 Magtiles 104 piezas de construcción. *Magtiles 104 Building pieces.*

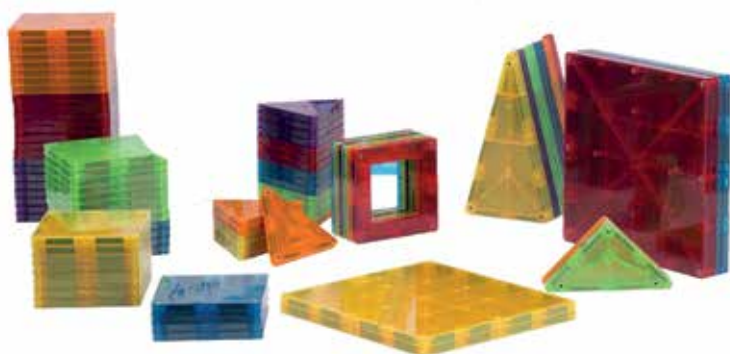



# MAGNETIC CUBES

## MAGNETIC CUBES

Magnetic Cubes tiene unas características mágicas: un diseño especial que permite que los bloques se conecten en los 6 lados diferentes del color, lo que hace que las estructuras sean fáciles y divertidas de crear. Especialmente para niños de 1 año en adelante que aprenden los colores y utilizan las fuerzas invisibles y mágicas del magnetismo para crear formas y estructuras en 3D, llevando los bloques de construcción a nuevas alturas creativas.

*Magnetic Cubes is magical feature a special design that allows the blocks to connect on all 6 different color sides making structures easy and fun to create. It is specially for kids ages 1 year and up to learn color and kids use the invisible and magical forces of magnetism to create shapes and 3d structures, taking building blocks to creative new heights.*

- 41127008 Magnetic Cubes 8 pcs.
- 41127027 Magnetic cubes 27 pcs
- 41127064 Magnetic cubes 64 pcs

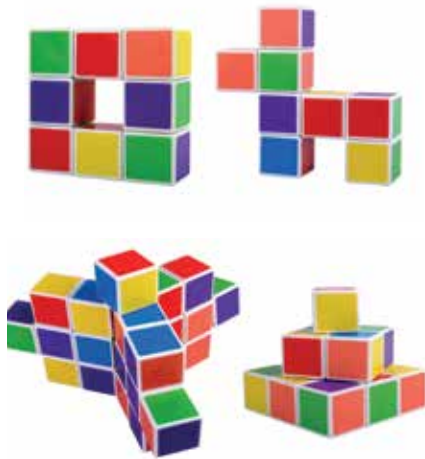

## 41127500 MAGNETIC ART CASE

70 unidades por set. Piezas magnéticas con 15 tarjetas. Esta caja sirve para estimular la imaginación de los niños y permitir a los más pequeños, elaborar sus propias historias usando las fichas magnéticas. Una vez la caja está abierta, puede transformarse en una gran pizarra de dibujo, ofreciendo a los niños un espacio libre, divertido y creativo.

*70 PCS/SET. Magnetic arts case with 15 cards. This case is to stimulate kids imagination and enables the little one to make up own stories using magnets. Once the case is opened, it can be "transformed" into a large drawing board, givin children mess-free creative fun.*



## 41127400 R-MAGBLOCK

Innovador set de bloques magnéticos que contiene diferentes formas y colores. Los bloques se atraen entre sí mediante un sistema de magnetismo patentado. Aprovechando su diseño moderno y magnetismo en cada cara, los MAGBLOCKS pueden atraerse entre sí libremente y crear diversas configuraciones interesantes.

*Innovative magnetic block set that containing different shapes & colors. The blocks attract each other by patent technology designed magnetism. Benefiting from its modern design and whole-side magnetism, the mag-blocks can attract each other freely and become many interesting configurations.*



# MAGFUN

## MAGNETIC BUILDING TUNEL

41127600 MAGFUN - MAGNETIC BUILDING TUNEL

¡Bloques de construcción con tubos de plástico. Diseñados para niños amantes de juegos educativos y DIY (Do It Yourself - Hazlo tú mismo)

*Construction Plastic Pipe Building Blocks Designer For Children DIY Educational Game.*



# SPACE CONSTRUCTION

41131200

Juego de construcción 3D para desarrollar la creatividad y la imaginación. Inicio en conceptos básicos de ciencia, tecnología, ingeniería y matemáticas a una edad temprana. Un juego divertido y educativo.

*41131200 Space Construction*

*3D construction game to develop creativity and imagination. Start in basic concepts of science, technology, engineering and mathematics at a young age. A fun and educational game. Book of examples with possible figures to perform depending on difficulty.*

*Composed of 160 pieces.*



PSICOMOTRICIDAD - PSYCOMOVEMENT



## ARBOL CONSTRUCCIÓN FANTASY MULTICOLOR



### 411 390 01 ÁRBOL CONSTRUCCIÓN FANTASY MULTICOLOR

Juego de construcción compuesto por piezas de 3 tamaños diferentes, con el que puedes armar diversos tipos de ramas y estructuras ramificadas. Puedes explorar cómo crecen los árboles y cómo surgen ciertos tipos de orden en la naturaleza. Entenderás, intuitivamente, que a través de la repetición de reglas sencillas, podrás generar estructuras más complejas. Se puede jugar durante horas, mientras se desarrollan distintas habilidades, estimula el cerebro y se ejercita la concentración.

- Fomenta el desarrollo social, cognitivo y lógico.
- Desarrolla la creatividad.
- Desarrolla la motricidad fina y la agudeza visual, tanto en niños como adultos.
- Está fabricado de plástico no tóxico, libre de BPA.
- A partir de 3 años.

*Construction game , composed of 3 type of piece sizes, wich you can build different kind of tree limbs and branch structures. Explore how the trees grow up and how it produces the nature sequence. You will learn intuitively that repeating some simple rules, you can obtain more elaborate structures. Could be played for hours, while develop different skills, stimulate the brain and train the concentration.*

- Promote social, cognitive and logic skills.
- Increase the creativeness
- Develop fine motor skills and visual acuity, to childs as to adults.
- Made of plastic, non toxic and BPA free.
- Includes 55 pieces
- Recommended age +3

### 411 390 02 ÁRBOL CONSTRUCCIÓN FANTASY VERDE



## FLOWER GARDEN



### 41139500 FLOWER GARDEN. 104 PCS.

Juego educativo basado en el diseño y construcción de un jardín de flores. Combina las diferentes partes de las flores de forma divertida, estimulando la imaginación la creatividad y la motricidad fina. Aprende las diferentes partes de las flores, especies etc.

Fabricado en materiales no tóxicos. Set de 104 piezas. A partir de 3 años.

*Educational game based on the creation of a flower garden. Mix the different flower parts on a funny way, spurring the imagination, creativeness and fine motor skills.*

*Use it to learn also different parts of flowers, their functions and vegetal species.*

*-Promote social, cognitive and logic skills.*

*-Increase the creativeness*

*-Develop fine motor skills and visual acuity, to childs as to adults.*

*-Made of plastic, non toxic and BPA free.*

*-Includes 104 pieces*

*-Recommended age +3*





# JUEGO DE ENGRANAJES

**41131300**

Juego de engranajes para construir estructuras tridimensionales con movimiento y reacciones en cadena. Piezas conectables con engranaje y movimiento. Ofrece gran libertad creativa a la vez que se aprenden conceptos básicos de mecánica de forma divertida. Incluye 340 piezas. Recomendado para niños y niñas de 5 a 12 años.

*41131300 Gear set*

*Game of gears to build three-dimensional structures with movement and chain reactions. Connectable parts with gear and movement. It offers great creative freedom while learning basic mechanics concepts in a fun way. It includes 340 pieces: Recommended for children from 5 to 12 years old*



PSICOMOTRICIDAD - PSYCOMOVEMENT



## 41131100 MAGIC WEAVING

Piezas flexibles conectables para unir entre sí y formar figuras en 2D y 3D. Con un solo tipo de pieza, se pueden crear multitud de objetos y formas, dando rienda suelta a la creatividad e imaginación.

Compuesto de 160 piezas de diferentes colores. Incluye ficha con diferentes ejemplos a realizar.

### 41131100 MAGIC WEAVING

*Joinable-flexible connectable pieces to join together and form figures in 2D and 3D. With a single type of piece, you can create a multitude of objects and shapes, allowing brain development creativity and imagination. Composed of 160 pieces of different colors. Includes guide book.*



## 41126000 EGGS GAME

Huevos de colores con numeración interna. Para juegos de reconocimiento del color, motricidad fina, clasificación y matemáticas. Set de 12 huevos + huevera.

*Colorful eggs numbered inside. For colour recognition games, fine motricity, maths and clasification. Set with 12 eggs + eggbox*





# MAGPAD DOTS

JUGUETES MAGNÉTICOS EDUCACIONALES  
MAGNETIC EDUCATIONAL TOYS

**41129700 MAGPAG - DOTS**

Compuesto por 130 lentejas de colores y 10 carteles con 20 ejemplos a realizar.

Mediante el lapicero imantado, hay que colocar las piezas en su posición correcta y crear los coloridos dibujos de las cartas, o dejar libre la imaginación.

Desarrolla la motricidad fina así como la imaginación.

Medidas, 31 cm x 31 cm.

*MAGPAD-DOTS is a new magpad, this with 130pcs dots and 10 double-sided picture cards.*

*Slide and match the colored disks into position with the magnetic wand to create colorful pictures or your own unique designs!.*

*Composed of 130 colored lentils and 10 posters with 20 examples to make. Use the magnetized pen to create colorful drawings and free shapes. It develops fine motor skills as well as imagination.*

*Measurements, 31 cm x 31 cm.*



PSICOMOTRICIDAD - PSYCOMOVEMENT



3+

PIEZAS  
MAGNÉTICAS  
Magnetic Drawing Board

2 PIEZAS

TABLA + LÁPIZ MAGNÉTICO

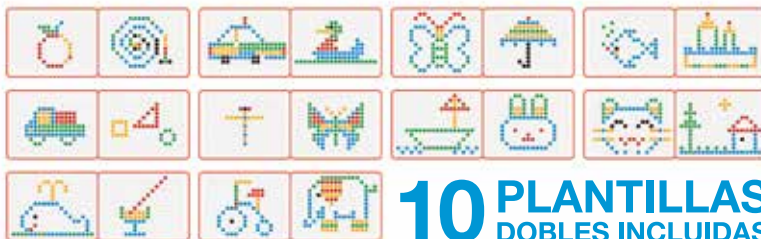

10 PLANTILLAS  
DOBLES INCLUIDAS

## DADOS CUENTA HISTORIAS

### DADOS cuenta historias Set 4. Story Dices

Divertido juego de dados para agudizar el ingenio y afinar la imaginación. En cada dado se pueden dibujar 6 imágenes, personajes, palabras, lugares, emojis, etc. El juego consiste en desarrollar la imaginación inventando una historia que combine las diferentes imágenes presentadas al lanzar los dados. El educador puede personalizar los dados, para poder tratar temas concretos, actuales, para desarrollar historias sobre un tema específico. Incluye rotulador. 4 colores. Fabricado en EVA, material suave.

*Funny dices game to sharpen your wits and spur your imagination. On each dice can be draw 6 graphics, characters, emojis, words, landscapes, etc. Can play storytelling using the different images drawn on the faces, rolling them and inspiring on the winning face. The teacher can customize the dices, to use them on a specific issue or lesson. Pen included. 4 colours. Made of soft EVA.*



432 296 00

#### Dado EVA Pizarra 75 x 75 mm. Set 4 unidades. + Rotulador.

Dado personalizable. Puede usarse como un dado tradicional, o con los dibujos, palabras, personajes etc, que se desee. Con varias unidades, puede utilizarse como Dado cuenta historias. Incluye rotulador. Tamaño 75 x 75 mm. Fabricado en EVA, material suave.

*Customizable dice. Can be used as traditional dice, or with drawings, words, emojis, or characters ... that you choose.*

*With more pieces, can be used also as storytelling dices.*

*Pen included. Size 75 x 75 mm. Made of soft EVA.*



432 295 00

#### Dado EVA Pizarra 10 x 10 cm. + Rotulador

Dado personalizable. Puede usarse como un dado tradicional, o con los dibujos, palabras, personajes etc, que se desee. Con varias unidades, puede utilizarse como Dado cuenta historias. Incluye rotulador. Tamaño 100 x 100 mm.. Fabricado en EVA, material suave.

*Customizable dice. Can be used as traditional dice, or with drawings, words, emojis, or characters ... that you choose.*

*With more pieces, can be used also as storytelling dices.*

*Pen included. Size 100\*100 mm. Made of soft EVA.*



## DADO FOAM VENTANAS

432 290 00

Dado personalizable. Puede usarse como un dado tradicional, o con los dibujos, fotografías, palabras, personajes etc, que se desee. También puede utilizarse como Dado cuenta historias. Cada cara dispone de una ventana transparente donde se puede introducir una hoja o cartulina con el diseño que se desee. Con varias unidades puede utilizarse como dado cuenta historias. Tamaño 100 mm x 100 mm. . Fabricado en Foam blando cubierto de vinilo. , material suave.

*Customizable dice. Can be used as traditional dice, or with drawings, words, emojis, or characters ... that you choose, and also use for storytelling activities. Each face has a transparent window, where can be placed a picture, cardboard, image, drawing... Size 100\*100 mm. Different colour faces. Made of foam and vinyl covered.*



PSICOMOTRICIDAD - PSYCOMOVEMENT



PIZARRA TABLET LCD

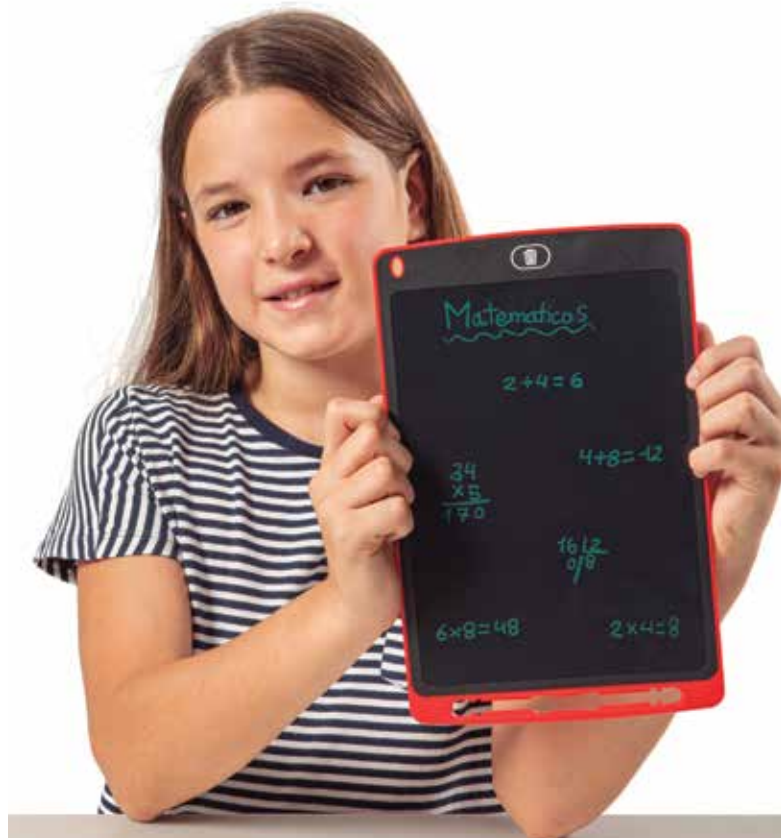

411 299 01

**Pizarra Tablet LCD De 8,5"**

Pantalla táctil de 8,5 pulgadas con tecnología LCD, que proporcionan una experiencia de calidad en la creación dibujos y textos.. Son ideales para poder dibujar, escribir apuntes, notas, listas de tareas, etc... Funciona con pila de botón. Material: LCD + ABS. Presión de escritura: 200-300g. Ratio de reflejo: 25%-30%  
 Tamaño pantalla: 8,5 pulgadas. Medidas: 227x 146 x 5 mm. Peso: 110 gr.

**LCD Tactile Screen 8,5"**

*Tactile screens with LED technology, that provides a quality experience in drawing and text elaboration. Perfect for drawings, write notes, homework lists..etc. Works with button battery. Material: LCD + ABS. Writing pressure: 200-300 gr. Reflex ratio: 25-30 %. Screen size: 8,5 inches. Measures: 227 x 146 x 5 mm. Weight: 110 gr.*



411 299 02

**Pizarra Tablet LCD De 10"**

Pantalla táctil de 10 pulgadas con tecnología LCD, que proporcionan una experiencia de calidad en la creación dibujos y textos.. Son ideales para poder dibujar, escribir apuntes, notas, listas de tareas, etc... Funciona con pila de botón. Material: LCD + ABS. Presión de escritura: 200-300g. Ratio de reflejo: 25%-30%  
 Tamaño pantalla: 10 pulgadas. Medidas: 265 x 170 x 6 mm. Peso: 165 gr.

**LCD Tactile Screen 10"**

*Tactile screens with LED technology, that provides a quality experience in drawing and text elaboration. Perfect for drawings, write notes, homework lists..etc. Works with button battery. Material: LCD + ABS. Writing pressure: 200-300 gr. Reflex ratio: 25-30 %. Screen size: 10 inches. Measures: 265 x 170 x 6 mm. Weight: 165 gr.*





411 299 50

**Pizarra Tablet LCD Transparente De 10"**

Pantalla táctil de 10 pulgadas con tecnología LCD, que proporcionan una experiencia de calidad en la creación dibujos y textos.. Son ideales para poder dibujar, escribir apuntes, notas, listas de tareas, etc...

Funciona con pila de botón. Material: LCD + ABS

Presión de escritura: 200-300g. Ratio de reflejo: 25%-30%

Tamaño pantalla: 10 pulgadas. Medidas: 268 x 167 x 5 mm.

Peso: 195 gr.

**LCD Tactile Screen Transparent De 10"**

*10" Tactile screens with LED technology, that provides a quality experience in drawing and text elaboration. Perfect for drawings, write notes, homework lists..etc.*

*Works with button battery. Material: LCD + ABS. Writing pressure: 200-300 gr. Reflex ratio: 25-30 %. Screen size: 10 inches. Measures: 268 x 167 x 5 mm.*

*Weight: 195 gr.*



411 299 03

**Pizarra Tablet LCD De 12"**

Pantalla táctil de 12 pulgadas con tecnología LCD, que proporcionan una experiencia de calidad en la creación dibujos y textos.. Son ideales para poder dibujar, escribir apuntes, notas, listas de tareas, etc...

Funciona con pila de botón. Material: LCD + ABS

Presión de escritura: 200-300g. Ratio de reflejo: 25%-30%

Tamaño pantalla: 12 pulgadas. Medidas: 282 x 170 x 6 mm.

Peso: 195 gr.

**LCD Tactile Screen 12"**

*Tactile screens with LED technology, that provides a quality experience in drawing and text elaboration. Perfect for drawings, write notes, homework lists..etc.*

*Works with button battery. Material: LCD + ABS. Writing pressure: 200-300 gr. Reflex ratio: 25-30 %. Screen size: 12 inches. Measures: 282 x 170 x 6 mm.*

*Weight: 195 gr.*



411 299 60

**Pizarra Tablet Osito LCD 10,5"**

Pantalla táctil de 10,5 pulgadas con tecnología LCD, que proporcionan una experiencia de calidad en la creación dibujos y textos.. Son ideales para poder dibujar, escribir apuntes, notas, listas de tareas, etc... Funciona con pila de botón. Material: LCD + ABS Presión de escritura: 200-300g. Ratio de reflejo: 25%-30% Tamaño pantalla: 10,5 pulgadas. Medidas: 248 x 223 x 5 mm. Peso: 169 gr.

**Bear LCD Tactile Screen 10,5"**

*10,5" Tactile screens with LED technology, that provides a quality experience in drawing and text elaboration. Perfect for drawings, write notes, homework lists..etc. Works with button battery. Material: LCD + ABS. Writing pressure: 200-300 gr. Reflex ratio: 25-30 %. Screen size: 10,5 inches. Measures: 248 x 223 x 5 mm. Weight: 169 gr.*



# MAGPAD

JUGUETES EDUCATIVOS MAGNÉTICOS

El MAGPAD es un soporte con una superficie perforada que contiene bolitas metálicas en su interior. Una sofisticada punta magnética extrae parcialmente hacia la superficie la bolita permitiendo al niño componer dibujos, grecas, formas geométricas, letras, números o cualquier diseño con el que desarrolle su imaginación disfrutando, bien imitando una de las diversas propuestas que contiene el MAGPAD o diseñando una nueva. De esta forma, no solo desarrolla su capacidad de interpretación espacial sino que estimula también su propia imaginación de un modo fácil y divertido.

## 411 295 MAGNETIC PAD + 10 CARDS

Dimensiones del soporte: 315 x 255 x 15 mm.

Bolitas: 714 uds. (34 x 21)

Color: negro y rojo

Incluye 10 Tarjetas con 20 modelos diferentes.

*Dimensions of the board: 315 x 255 x 15 mm.*

*Beads: 714 pcs. (34 x 21)*

*Colour: black and red*

*Includes 10 cards with 20 different templates*

714 PIECES  
Ball pops

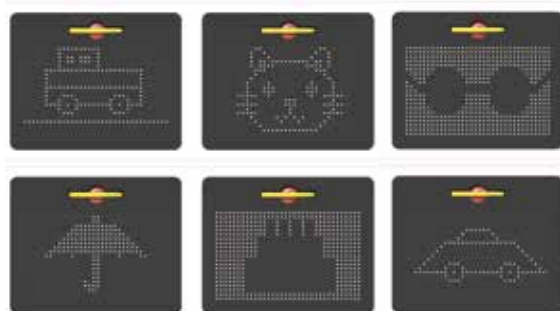

# MAGPAD Mini

## 411 296 MAGNETIC PAD MINI + 10 CARDS

Dimensiones del soporte: 218 x 175 x 15 mm.

Bolitas: 380 uds. (20 x 19)

Color: negro y rojo

Incluye 10 Tarjetas con 20 modelos diferentes

*Dimensions of the board: 218 x 175 x 15 mm.*

*Beads: 380 pcs. (20 x 19)*

*Colour: black and red*

*Includes 10 cards with 20 different templates*

380 PIECES  
Ball pops

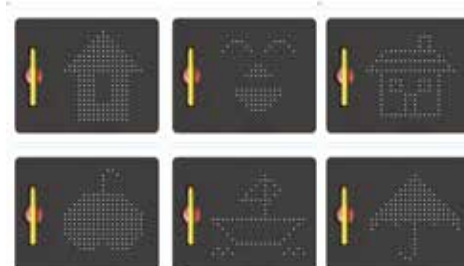
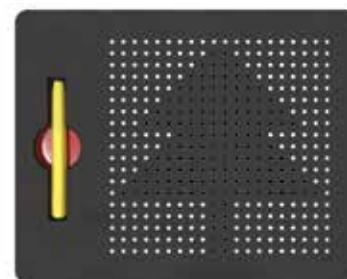



# PIEDRAS DE RÍO RIVER STONES



## 411 895 PIEDRAS DE RÍO

Set de 8 piedras. Fabricadas en TECNOCAUCHO semi blando anti deslizante.

### MEDIDAS

1. Piedra porosa redonda negra: 213 x 260 mm. Altura: 133 mm.
2. Piedra porosa plana negra: 260 x 202 mm. Altura: 62 mm.
3. Piedra gris 260 x 142 mm. Altura: 83 mm.
4. Piedra blanca grande: 260 x 254 mm. Altura: 122 mm.
5. Piedra blanca alta 260 x 196 mm. Altura: 150 mm.
6. Piedra blanca pequeña 260 x 194 mm. Altura: 142 mm.
7. Piedra porosa negra 260 x 194 mm. Altura: 142 mm.
8. Piedra gris 270 x 220 mm. Altura: 105 mm.

## RIVERSTONES

Set of 8 Stones. Made of Tecnorubber, soft and non-slipping.

### DIMENSIONS

1. Porous round shape black stone: 213 x 260 mm. Height: 133 mm.
2. Porous flat shape black stone: 260 x 202 mm. Height: 62 mm.
3. Grey stone 260 x 142 mm. Height: 83 mm.
4. Big white stone: 260 x 254 mm. Height: 122 mm.
5. Tall white stone 260 x 196 mm. Height: 150 mm.
6. Small white stone 260 x 194 mm. Height: 142 mm.
7. Porous black stone 246 x 230 mm. Height: 70 mm.
8. Grey stone 270 x 220 mm. Height: 105 mm.



## 411 898 ISLAS DE EQUILIBRIO

Set de 6 piezas. Fabricadas en TECNOCAUCHO semi blando anti deslizante. Diámetro: 15 cm. Altura: 7,50 cm. Peso: 300 g.

Islands for balancing acts. Made of non-slip semi soft techno-rubber. Set 6 pieces. Diameter: 15 cm. Height: 7,50 cm. Weight: 300 g.



## 412 245 SET DE ISLAS JUMP

Con bases antideslizantes. Juego de equilibrio. Compuesto por 5 islas alargadas y 5 islas redondas.

Islands set "jump" with non-slip bases. Balance play. Contents: 5 long half cylinder pieces. 5 hemyspheres.

# PASILLO ISLAS BALANCE PATH ISLANDS



PSICOMOTRICIDAD - PSYCOMOVEMENT

## 412 241 - PASILLO ISLAS CON DISCOS INTERCAMBIABLES

Juego de equilibrio y aprendizaje que ofrece múltiples combinaciones y actividades diferentes. Las bases se pueden apilar, creando desniveles acordes a la habilidad de los pequeños. Incluye discos intercambiables de diferentes colores y números.

Compuesto por:

7 bases antideslizantes de 30 cm de diámetro x 10 cm de altura

10 puentes de unión de 72 x 12,5 cm.

7 círculos de colores intercambiables.

Fabricado en materiales no tóxicos.

## *BALANCE PATH ISLANDS WITH INTERCHANGEABLE PLATES*

*Balancing and learning path for making different paths and activities. Stackable islands and possible to make different heights and slopes according to the children ability. With interchangeable plates with different color and numbers.*

*The set contains:*

*7 non-slip islands, diameter 30 cm, 10 cm high.*

*10 connecting bridges 72 x 12.5 cm.*

*7 interchangeable color plates.*

*Non-toxic.*



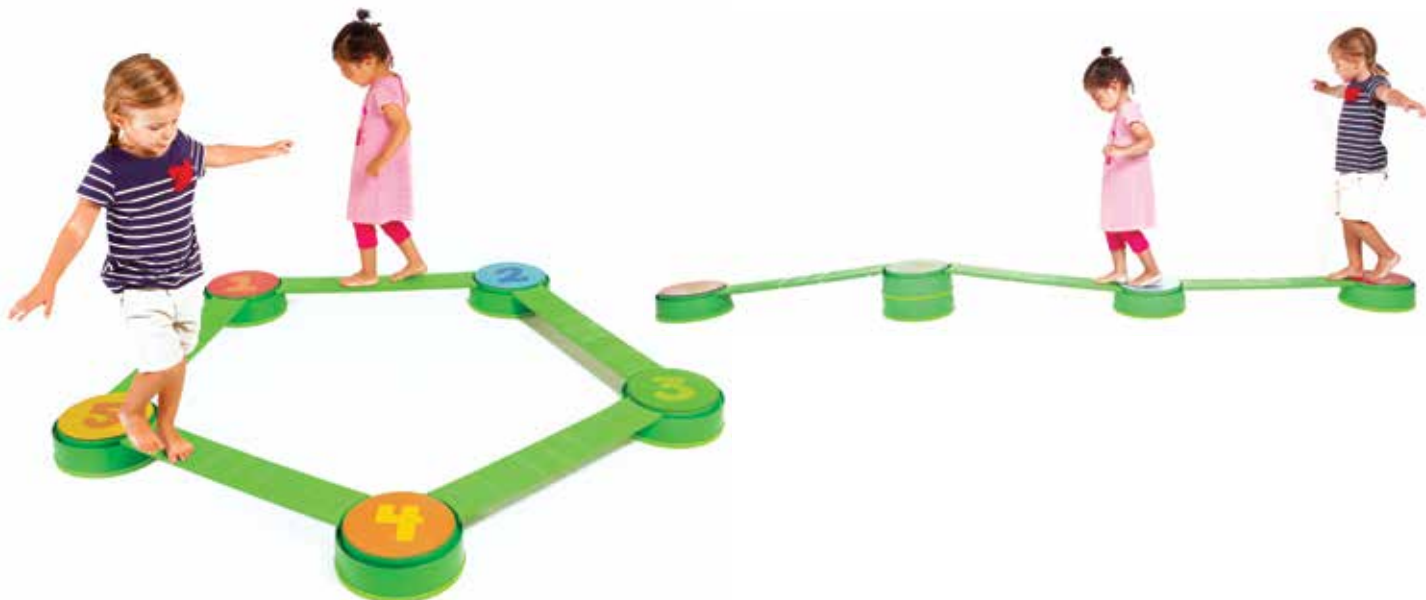

### 412 242 - PASILLO ISLAS CON DISCOS INTERCAMBIABLES

Juego de equilibrio y aprendizaje que ofrece múltiples combinaciones y actividades diferentes. Las bases se pueden apilar, creando desniveles acordes a la habilidad de los pequeños. Incluye discos intercambiables de diferentes colores y números.

Compuesto por: 5 bases antideslizantes de 30 cm de diámetro x 10 cm de altura - 5 puentes de unión de 72 x 12,5 cm. - 5 círculos de colores intercambiables. - Fabricado en materiales no tóxicos.

### BALANCE PATH ISLANDS WITH INTERCHANGEABLE PLATES

Balancing and learning path for making different paths and activities. Stackable islands in order to make different heights and slopes according to the children's ability. With interchangeable plates with different color and numbers.

The set contains: 5 non-slip islands, diameter 30 cm, 10 cm high. - 5 connecting bridges 72 x 12.5 cm. - 5 interchangeable color plates. Non-toxic.



### 412 243 - PASILLO ACOPLABLE SNAKE

Conjunto de piezas que disponen de un fácil sistema de acoplado de manera que los niños pueden crear innumerables recorridos desarrollando sus habilidades motrices. Con base y superficie antideslizante TACTO SOFT para mayor seguridad. Set de 10 piezas. Medidas: Longitud 350 mm, Anchura 95 mm. y 45 mm. de altura.

### BALANCE PATH SNAKE

Set with pieces with easy-to-handle connector system. Even children can make the assembly of different paths. For developing motor skills. Non-slip bases and non-slip SOFT surface. Set of 10 paths. Measurements: 350 mm long, 95 mm wide, 45 mm high.



## Pasillo de equilibrio multi posición 30 aniversario

### **41224600 Pasillo de equilibrio multiposición 30 aniversario**

Hace 30 años sacamos al mercado el primer pasillo de equilibrio del mundo. Tras su rotundo éxito, nuestra empresa ha sido siempre un referente en el mundo de la psicomotricidad a nivel mundial.

Para celebrar este acontecimiento hemos decidido realizar un nuevo diseño, estilizando las formas y con un nuevo sistema de multi-posición, una ingeniosa conexión patentada con la cual pueden realizarse circuitos rectos y curvos con la misma pieza y sin ningún esfuerzo.

Set de 10 piezas. Medidas: Longitud 40 cm, Anchura 14 cm. y 15 cm. de altura.

### **41224600 Multi-position corridor 30th anniversary**

30 years ago we brought to the market the first balance corridor in the world. After its success, our company has always become a psychomotor worldwide referent .

To celebrate this event we have decided to make a new design, stylizing shapes and offering a whole new multi-position system, an ingenious connection patented which allows easy connections between straight and curved circuits .





412 225



412 235



412 230



412 240

Piezas acoplables para nuestros pasillos. Fabricadas en material de primera calidad. Fáciles de unir. Junto con nuestros pasillos, se pueden crear infinidad de recorridos diferentes. Muy versátil.

*New pieces to connect all of our sensorial paths easily. They are made of material of the best quality. They can be combined with sensorial path pieces to create almost any shape you desire. Assorted colours.*

**412 225** Cruz de unión pasillo acoplable. *Piece for connect the straight and curve paths.*

**412 230** Cruz de unión pasillo semicircular. *Piece to connect the half-cylinder paths.*

**412 235** Pieza de unión pasillo acoplable a semicircular. *Piece to connect high paths with half-cylinder paths.*

**412 240** Pieza de inicio pasillo semicircular antideslizante. Set 2 unidades. *Little non-slip piece to finish off the paths.*



**412 100 PASILLO SEMICILÍNDRICO RECTO**

Acoplable, longitud 29,5 cm. Set de 10 piezas. - *Half-cylinder straight path. 29,5 cm. length. Set of 10 pieces.*

**412 200 PASILLO SEMICILÍNDRICO CURVO**

Acoplable, longitud 29,5 cm. Set de 10 piezas. - *Half-cylinder curve path. 29,5 cm. length. Set of 10 pieces.*

# Sensaciones plantares 30 aniversario



## Sensaciones plantares 30 aniversario

Hace 30 años sacamos al mercado el primer juego de sensaciones plantares del mundo. Tras su rotundo éxito, nuestra empresa ha sido siempre un referente en el mundo de la psicomotricidad a nivel mundial. Para celebrar este aniversario hemos decidido realizar un nuevo diseño, estilizando las formas, pero manteniendo nuestra invención.

## Sensorial path 30th anniversary

30 years ago we brought to the market the first set of sensorial paths in the world. After its success, our company has always become a psychomotor worldwide referent.

To celebrate this anniversary we have decided to make a new design, stylizing the forms, but keeping our invention.



### 43829100 Set Sensaciones Plantares Basic. 30 aniversario

Incluye 6 placas de plástico con base antideslizante ( Pincho fino, Pincho grueso, Línea fina, Línea gruesa, Agujeros y Líneas curvas)  
Medidas: 30 x 30 cm.

*Basic Sensorial Path. 30th anniversary*

*Includes 6 plastic plates + anti-slip bases (Fine Pincho, Coarse Pincho, Thin Line, Thick Line, Holes and Curved Lines). Measures: 30 x 30 cm.*

### 43829200 Set Sensaciones Plantares Basic + Mini sensaciones. 30 aniversario

Incluye 6 placas de plástico con base antideslizante ( Pincho fino, Pincho grueso, Línea fina, Línea gruesa, Agujeros y Líneas curvas) + 1 set Mini Sensaciones Plantares basic. Medidas: Grandes 30 x 30 cm. Pequeñas 10 x 10 cm.

*Basic Set Sensorial Path + Baby Sensorials. 30th anniversary*

*Includes 6 plastic plates + non-slip bases (Fine Pincho, Coarse Pincho, Thin Line, Thick Line, Holes and Curved Lines) + 1 set baby sensorials Measurements: Large 30 x 30 cm. Small 10 x 10 cm*

### 43829300 Set Mini Sensaciones Plantares. 30 aniversario

Incluye 6 placas de plástico Mini, sin Base ( Pincho fino, Pincho grueso, Línea fina, Línea gruesa, Agujeros y Líneas curvas)  
Medidas: 10 x 10 cm.

*Baby Sensations Set. 30th anniversary*

*Includes 6 Mini plastic plates, without Base (Fine Pincho, Coarse Pinch, Thin Line, Thick Line, Holes and Curved Lines)  
Measures: 10 x 10 cm.*





**43829000 Set Sensaciones Plantares Original.**

Incluye 6 placas de plástico con base antideslizante ( Pincho fino, Pincho grueso, Línea fina, Línea gruesa, Agujeros y Líneas curvas), Moqueta, Esparto, Foam y césped artificial. También se incluyen 2 bases antideslizantes vacías que se pueden rellenar con otro tipo de materiales según las preferencias del educador. Por ejemplo, agua fría, agua caliente, arena de playa, arena kinética, pequeñas piedras, tierra, etc... Incluye 6 bases.

Medidas: 30 x 30 cm.

*1.- 43829000 Original Sensorial Path.*

*Includes 6 plastic plates with anti-slip base (Fine Pincho, Coarse Pincho, Thin Line, Thick Line, Holes and Curved Lines), Carpet, Esparto, Foam and artificial turf. Also includes 2 empty anti-slip bases that can be filled with other types of materials according to the preferences of the educator. For example, cold water, client water, beach sand, kinetic sand, small stones, soil, etc...*

*Include 6 bases.*

*Measures: 30 x 30 cm.*



**438 300** Pasillo "Sensaciones plantares". 12 bases y 10 placas: madera, cerámica, moqueta, esponja, esparto y 5 de plástico.

*Sensorial patch. 12 bases and 10 sheets: wood, ceramics, carpet, sponge, esparto grass and 5 of plastic.*

**438 301** Base de sustitución "Sensaciones plantares" - *Sustitution base for "sensorial path"*

# SUELO SENSORIAL LIQUIDO

*Suelo compuesto por baldosas rellenas de líquido sensorial que cambian de color al pisarlas, produciendo una sensación muy agradable y estimulando el desarrollo sensorial y perceptual. Perfecto para centros infantiles, habitaciones sensoriales, hogares... etc. Set de 6 placas con 6 colores diferentes y base antideslizante.*

Sensory liquid floor tiles with flowing and swirling colours as you press them, producing a very pleasant sensation and stimulating sensory and perceptual development. Perfect for children centres, sensory rooms, homes... etc. Set of 6 tiles with 6 different colours and anti-slip base.

**438 315** Suelo sensorial líquido grande 6 PCS. 50 x 50 cm.  
*Large sensory liquid floor tiles 6 PCS. 50 x 50 cm.*

**438 316** Suelo sensorial líquido pequeño 6 PCS. 30 x 30 cm.  
*Small sensory liquid floor tiles 6 PCS. 30 x 30 cm.*



**438 315 SUELO SENSORIAL LIQUIDO GRANDE. 6 PCS. 50 X 50 CM.**

**438 316 SUELO SENSORIAL LIQUIDO PEQUEÑO. 6 PCS. 30 X 30 CM.**





# BALANCE PADS



**530 509 CONJUNTO DE 6 ALMOHADILLAS EQUILIBRIO (CIRCULO, ROMBO, HEXÁGONO, CUADRADO, TRIÁNGULO Y ELIPSE)**

Set de 6 piezas. Fabricado en termoplástico semi-suave, antideslizante. Formas diferentes: redonda, cuadrada, rombo, hexágono, triángulo y elipse. MEDIDAS: Redonda: Ø 25 cm. Cuadrada: 23 x 23 cm. Hexagonal: 23 x 23 cm. Rombo: 36 x 23 cm.

Set of 6 pieces. Made of semi-soft thermoplastic, non-slipping and different shapes: Round, square, diamond, hexagon, triangle and elipsis. DIMENSIONS: Round Diameter: 25 cm. Square: 23 x 23 cm. Hexagon: 23 x 23 cm. Diamond: 36 x 23 cm. Weight: 500gr

**530 512 CONJUNTO DE 4 ALMOHADILLAS EQUILIBRIO (CIRCULO, ROMBO, HEXÁGONO y CUADRADO)**

Set de 4 piezas surtidas aleatoriamente. Formas: redondo, cuadrado, rombo, hexágono, triángulo y elipse. Fabricado en termoplástico semi-suave. 4 assorted pieces. Shapes: round, square, diamond, hexagon, triangle and ellipse. Made of semi-soft thermoplastic.



**530 513 CONJUNTO ALMOHADILLAS EQUILIBRIO (4 CIRCULOS) - BALANCE PADS SET (4 CIRCLES)**

Set de 4 piezas. Fabricado en termoplástico semi-suave, antideslizante. Forma redonda Ø 25 cm. Pso: 500 gr.

Set of 4 pieces. Made of semi-soft thermoplastic, non-slipping. Round Diameter: 25 cm. Weight: 500gr

**530 511 DISCO DE EQUILIBRIO REDONDO 1 unidad**

BALANCE ROUND PAD - 1 piece

# RAYUELA

**437 385 JUEGO DE SALTO RAYUELA**

10 Baldosas puzzle con 10 numeraciones diferentes. Fabricadas en Eva adecuado para niños. Medidas de las baldosas: 32 x 32 Grosor: 1 cm.

**HOP-SCOTCH GAME**

10 Numbered Puzzle tiles. Made of EVA. Suitable for children. Tile Size: 32x32 Thickness: 1cm



**411 746 RELOJ DE PARED**

Reloj de pared puzzle. Fácil montaje. Fabricadas en Eva adecuado para niños. Diametro: 46 cm. Grosor: 1,2 cm.

**WALL CLOCK**

Made of EVA. Suitable for children. Easy to assemble. Diameter: 46 cm. Thickness: 1,2 cm.

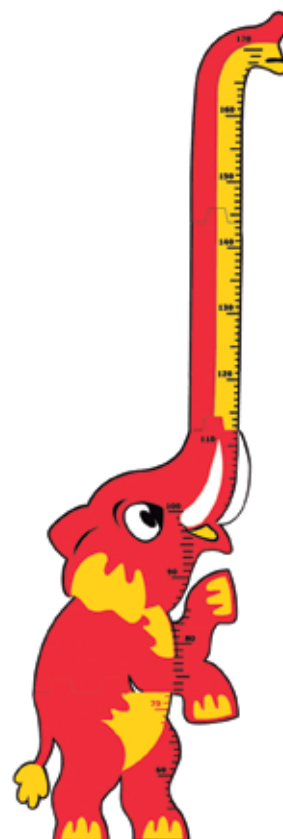

**411 748 ELEFANTE MEDICIÓN ALTURA**

Elefante con metro de medida 170 cm. Fabricada en EVA especial para niños. MEDIDAS: 170 X 45 cm.

**WALL HEIGHT CHART ELEPHANT**

Wall metre Height 170 cm. Made of EVA. Suitable for children. Dimensions: 170 X 45 cm.



# LOCOMOTORA

## 437 394 LOCOMOTORA

Fabricada en EVA adecuado para niños. Material suave y seguro. Fácil montaje.

ANCHURA : 800 mm. LONGITUD: 1240 mm. ALTURA TOTAL: 1000 mm.

### LOCOMOTORA

Made of EVA. Suitable for children. Soft and safe material. Easy to assemble.

WIDTH : 800 mm. LENGTH: 1240 mm. TOTAL HEIGHT: 1000 mm.



# CASITA MULTICOLOR

## 437 999 LA CASITA MULTICOLOR

Casita multicolor. Fácil montaje. Fabricadas en Eva adecuado para niños. Material suave y seguro. MEDIDAS: 112 x 64 cm. Altura: 115 cm.

### MULTICOLOUR HOUSE

Made of EVA. Suitable for children.

Soft and safe material. Easy to assemble.

DIMENSIONS: 112 x 64 cm. HEIGHT: 115 cm.



PSICOMOTRICIDAD - PSYCOMOUMENT

# SEMIESFERAS GIGANTES SUPER BALANCE DOME



## 411 896 SEMIESFERAS GIGANTES DE EQUILIBRIO - SUPER BALANCE DOME

Set de 4 semiesferas de distintos tamaños. Fabricadas en polietileno. Con base antideslizante.  
Set: 4 domes of different sizes. Made of polyethylene with non-slipping base.

**MEDIDAS/ MEASURE:**

- Ø 750 mm. Altura: 375 mm. Peso: 5 kg. - Ø 750 mm. Height: 375 mm. Weigh: 5 kg.
- Ø 600 mm. Altura: 300 mm. Peso: 3.2 kg. - Ø 600 mm. Height: 300 mm. Weigh: 3,2 kg.
- Ø 445 mm. Altura: 222 mm. Peso: 2.2 kg. - Ø 445 mm. Height: 222 mm. Weigh: 2,2 kg.
- Ø 350 mm. Altura: 175 mm. Peso: 1.1 kg. - Ø 350 mm. Height: 175 mm. Weigh: 1,1 kg.

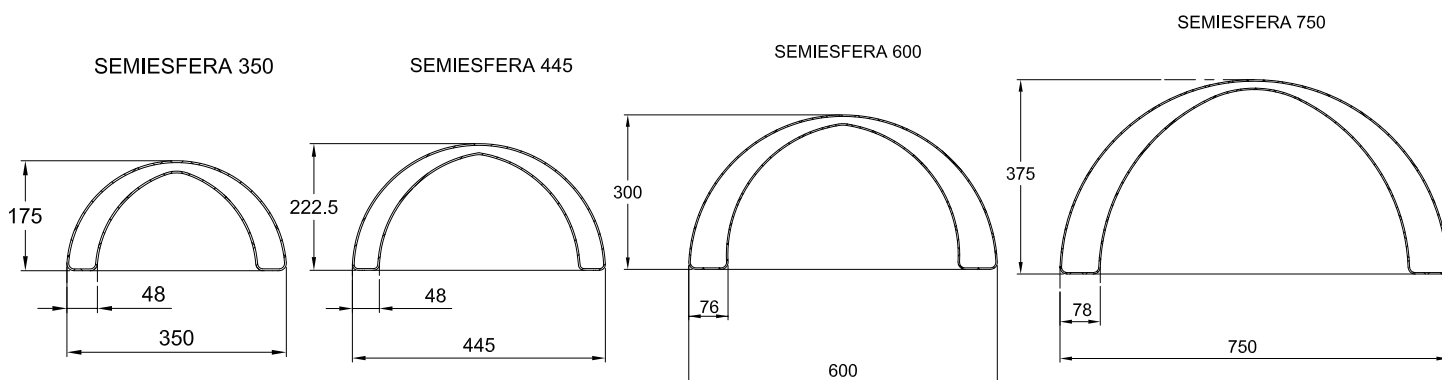



# RECORRIDO MOTRIZ MOTOR DEVELOPMENT CENTER



Ø74,5 x 39 cm.



47,5 x 40 x 38,5 cm.



111 x 55,5 x 38,5 cm.



117 x 28 x 50 cm.



117 x 28 x 27 cm.



70 x 28 x 13 cm.

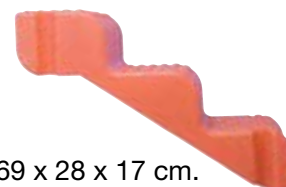

69 x 28 x 17 cm.

## 438 200

Recorrido motriz de 7 piezas. Módulos de plástico de gran tamaño que ofrecen múltiples combinaciones. Un juego didáctico con muchas posibilidades de aprendizaje y diversión que les ayudará a desarrollar las habilidades motoras, tomar decisiones y coger confianza en sí mismos. Fabricadas en sistema de rotomoldeo con materiales homologados por la unión europea, bajo la normativa EN-72. Cada pieza tiene una superficie diferente: líneas, puntos, círculos, olas, cuadros, etc... lo que permite la realización de ejercicios de reconocimiento táctil. Novedoso sistema de unión de las piezas super seguro que evitan el desplazamiento de las mismas. Muy ligeras, para que los niños las puedan transportar y hacer las combinaciones que deseen. Muy resistentes; aguantan más de 300 Kg. Fácil limpieza y almacenamiento.

*Set with 7 plastic modules that offer multiple combinations. A center with many possibilities of game, for enhancing motor skills, take decisions and improve confidence. Made with rotational molding system with materials approved by the European Standard Norm EN-71 for toys. Each piece has a different surface: lines, dots, circles, waves, charts etc.. Possible to make tactile exercises. New system of joining pieces very safe. Light and resistant. Easy cleaning and storage. Weight load: 300 kg.*

# ZANCOS

411 200 ZANCOS BAJOS



411 201 ZANCOS ALTOS DE PLÁSTICO

Altura 1,50 m. 1ª altura: 17 cm; 7ª altura: 47 cm.

High plastic stilts. 1,5 m. high, 1st height 17 cm. ; 7th height 47 cm.



411 202 ZANCOS ALTOS CON PALOS DE MADERA

Longitud: 150 cm.

High wooden stilts. Length: 150 cm.



# TUNEL TREN



**437 401** Set standard compuesto por cabeza, cola y tres vagones centrales. Medidas: largo: 240 cm. Ancho: 84 cm. Alto: 64 cm.

## TRAIN TUNNEL

Standard set made of head, tail and three central wagons. Measures: length: 240 cm. Width: 84 cm. Tall: 64 cm.

**437 402** Vagones centrales unitarios. - Single central wagons.



## 437 395 TUNEL LOCOMOTORA - FUNNY TRAIN

Fabricada en EVA adecuado para niños. Material suave y seguro. Fácil montaje

Medidas: ANCHURA TUNEL : 850 mm. ALTURA TUNEL: 460 mm. ALTURA TOTAL: 770 mm. LONGITUD: 1400 mm.

Made of EVA. Suitable for children. Soft and safe material. Easy to assemble. TUNNEL WIDTH : 850 mm. TUNNEL HEIGHT: 460 mm TOTAL HEIGHT: 770 mm. LENGTH: 1400 mm.







437 412 Tunel de reptación redondo ø 48 cm. 1,8 metros de largo. - Pop up rounded tunnel ø 48 cm. 1,8 meters length.

437 415 Tunel de reptación redondo ø 70 cm. 1,8 metros de largo. - Pop up rounded tunnel ø 70 cm. 1,8 meters length.

437 420 Tunel de reptación redondo ø 90 cm. 3,7 metros de largo. - Pop up rounded tunnel ø 90 cm. 3,7 meters length.



437 413 TÚNEL REPTACION CURVO- REDONDO Ø 48cm .Largo 2 mt.

Tunel fabricado en nylon de gran resistencia. Curva de 180°. Plegado fácil. Con sistema de unión entre varios túneles para realizar recorridos.

Round- curved tunnel. Diameter 48cm, length: 2m. Made of resistant nylon. Curve of 180°. Easy union between tunnels to make trails.



437 425 Tunel de reptación de nylon con 6 caminos. Ø 45 x 75 cm. - Nylon crawl rounded tunnel with 6 ways. Ø 45 x 75 cm.

**PSICOMOTRICIDAD - PSYCOMOVEMENT**



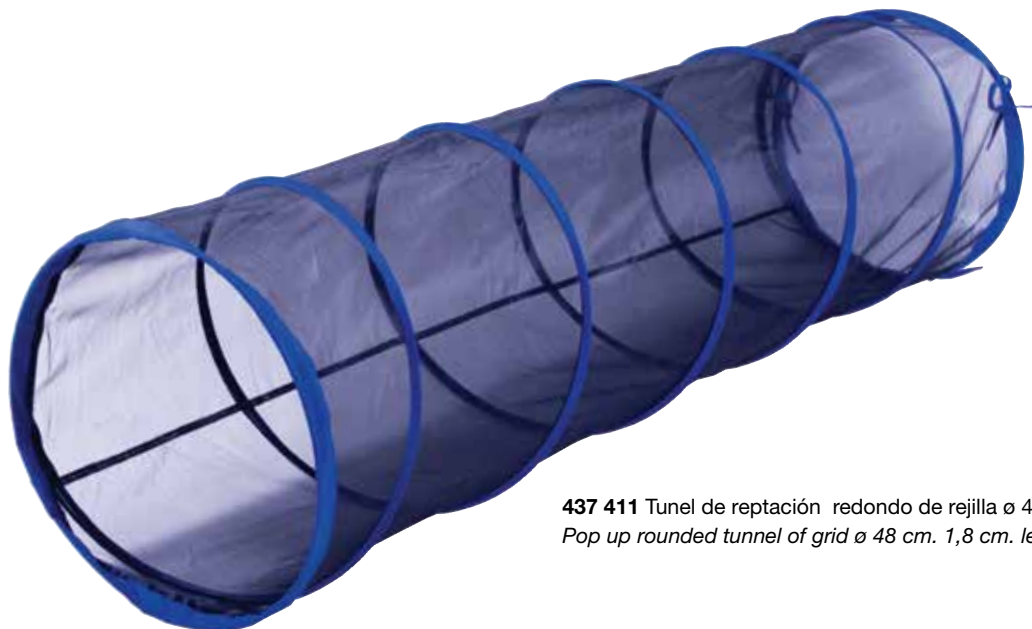

**437 411** Tunnel de reptación redondo de rejilla  $\phi$  48 cm. 1,8 metros de largo.  
*Pop up rounded tunnel of grid  $\phi$  48 cm. 1,8 cm. length.*



## LA CUEVA THE CAVE

PSICOMOTRICIDAD - PSYCOMOVEMENT

### 412 248 LA CUEVA - THE CAVE

La cueva es una estructura robusta ,portátil que se puede plegar cuando no se vaya a utilizar. Dentro la oscuridad es total, ideal para realizar juegos de estimulación sensorial, percepción etc...

Medida 1x1x1 Cueva. Túnel de 1,5 m, Diámetro 48 cm.

*The Cave is a portable and foldable tent. It has a nylon double skin to get complete darkness inside. For sensorial stimulation and different games. Cave Measure 1x1x1. Tunnel measure L: 1,5m. long. Diameter: 48mm*



**412 249** Luminosos para la cueva. Set de 6 unidades.  
 Set de 6 figuras, con luz led que cambia de color. Para usar dentro de la Cueva.

*Set of 6 figures, with led light with color changer. For using inside of the Cave.*

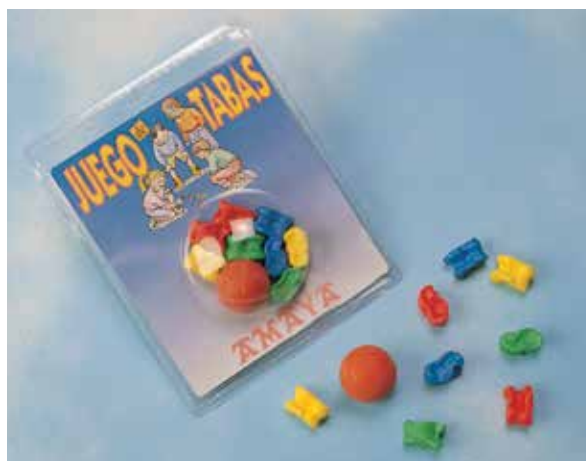

412 800 Juego de tabas. 8 tabas + 1 pelota - Knucklebones. (8 knucklebones + 1 ball).



422 000 Cuerda de guardería con cascabeles. Longitud: 10 m. - Kids rope with bells. Length: 10 m.



432 300 Dado P.E. de 20 x 20 cm. - PE dice 20 x 20 cm.  
432 400 Dado P.E. de 15 x 15 cm. - PE dice 15 x 15 cm.

432 401 Dado cascabel perfumado de 15 x 15 cm. Amarillo: limón Azul: piña - Fucsia: fresa - verde: menta - naranja: naranja - morado: multifruta.  
Scented dice with bell 15 x 15 cm. Yellow: lemon - Blue: pineapple - Fuchsia: strawberry - green: mint - orange: orange - violet: multifruit.

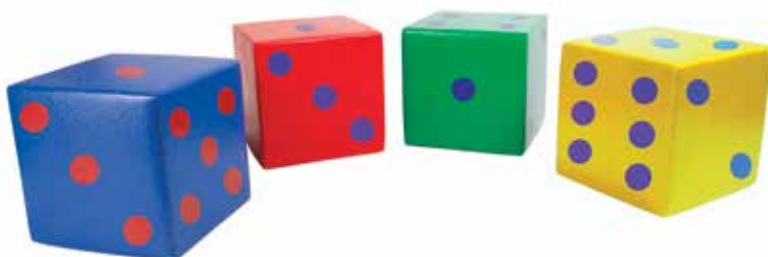

455 001 Dado Foam de 20 x 20 cm. - Mousse dice 20 x 20 cm.

PSICOMOTRICIDAD - PSYCOMOVEMENT



# SENSACIONES TÁCTILES



## SENSACIONES TÁCTILES

El niño desarrolla jugando el sentido del tacto, aprendiendo a diferenciar diferentes figuras geométricas así como las letras del abecedario y los números. Contiene 9 figuras geométricas, 10 números y 26 letras.

## TOUCH SENSATIONS

The children develop the sense of touch playing, learning to distinguish different geometric figures as well as alphabet letters and numbers. It contains 9 geometric figures, 10 numbers and 26 letters.

411 704 Set completo - Complete set.



# SENSACIONES OLFATIVAS

Permite desarrollar el sentido del olfato de los niños a la vez que detectar posibles anomalías.

Juego con 12 recipientes con distintos aromas. Cada recipiente tiene un número marcado en su base y el set adjunta un listado que descifra qué aroma corresponde con cada número.

The game develops the sense of smell in children and allows to detect possible anomalies.

Set with 12 recipients with different scents.

The recipients have a number printed in their bottom. The set find enclose a writing that disclose which scent is every number.



## 432 900 SET AROMAS

Nº 1: Limón - Lemon. - Nº 2: Fresa - Strawberry. - Nº 3: Plátano - Banana. - Nº 4: Coco - Coconut. - Nº 5: Melón - Melon. - Nº 6: Naranja - Orange. - Nº 7: Piña - Pineapple. - Nº 8: Menta - Mint. - Nº 9: Jazmín - Jasmine. - Nº 10: Chocolate - Chocolate. - Nº 11: Manzana - Apple. - Nº 12: Rosas - Roses.





439 090 PARACAIDAS 1,8 M. 9 asas. - Parachute 1,8 m. 9 handles.

439 100 PARACAIDAS 3,5 M. 12 asas. - Parachute 3,5 m. 12 handles.

439 110 PARACAIDAS 6 M. 20 asas. - Parachute 6 m. 20 handles.

439 120 PARACAIDAS 7,5 M. 16 asas. - Parachute 7,5 m. 16 handles.





439 200 MÁSTIL CON 12 CINTAS Y BASE - Pole with 12 ribbons and big base.



439 300 GRAN BASE UNIVERSAL Ø 42 CM.  
ALTO 15 CM.  
Big universal base Ø 42 cm. Height 15 cm.



**411 880 CHICHONERAS. 1 Unidad**

Recomendado para bebés que comienzan a caminar y para bebés de 1 a 3 años que realicen ejercicios en los que tengan riesgos de caída. Por ejemplo cuando estén en columpios, parques infantiles, hinchables, etc...

Muy recomendado para bebés con un chichón en la cabeza que necesite protección frente a una segunda posible caída. Testado en niños de 1 a 3 años.

**Head band protector. 1 unit.**

Protect babies against falling down. Head band shock-absorbing. Protect frontal bone and occipital bone. MATERIAL: Elastic band soft and comfortable with designs made of antistress PU foamed material placed in frontal and occipital area. Recommended for babies learning to walk

Recommended for babies from 1 to 3 years playing in a park, swings, air castle, etc... Recommended for babies with a bump on the head with a need of being protected against a second fall.

**411 881 CHICHONERAS. 5 Unidades. - Head band protector. 5 units.**



412 600 TARRO LUPA - Pots lens.





# JUMPING CAR



## COCHE INFANTIL HINCHABLE SALTARÍN - INFLATABLE JUMPING CAR

Coche hinchable de atractivo diseño, ideal para que los más pequeños realicen ejercicios de fuerza y coordinación. Al jugar con el coche durante la edad de crecimiento, se fortalecen los músculos y la estabilidad de la columna. Favorece el desarrollo de la coordinación y el equilibrio mientras los niños se divierten. Se pueden realizar innumerables juegos y actividades. Dispone de asas donde agarrarse y poder dar saltos. Se puede utilizar tanto en interior como en exterior. Fácil de limpiar. Fabricado en material muy resistente, acorde a todas las normativas Europeas vigentes. ¡Peso 1800 gramos. Medidas. 49cm largo, 36cm ancho, 37cm alto.

*Inflatable car with a nice design and ideal for young children to train their strength and coordination. It develops coordination and balance and helps to strengthen the muscles and the stability of the spine, while children have fun. Children will be able to perform countless games and activities. It has handles to grab and jump. Suitable for both, indoors and outdoors use. Easy to clean. Made of very resistant material. Complies with current European regulations. Weight: 1800 g. Dimensions 49cm long, 36cm wide, 37cm tall.*



**436 807** Jumping Car Ambulancia  
Jumping Ambulance



**436 806** Jumping Car Taxi  
Jumping Taxi



**436 808** Jumping Car Policía  
Jumping Police Car



**436 805** Jumping Car Carreras - Jumping Race Car



# Kanguro anti-explosión

## Special no-burst kangaroo

# KANGURO

Un clásico renovado. Kanguros fabricados con TPE foamizado, un material novedoso con sistema antiexplosión, lo que le da una garantía de seguridad nunca vista en un producto de estas características. En caso de pinchazo por causa de algún objeto puntiagudo, el Kanguro se deshincha lentamente, sin explotar, evitando así posibles lesiones de los más pequeños.

*We have developed a new mixture in our materials, in order to give these kangaroos more security guarantee and flexibility. If a ball have a sting the kangaroo loss the air slowly, without blowout. We avoid any damage for children.*

436601 Kanguro Ø 45 cm. anti-explosión. - Kangaroo Ø 45 cm. No-burst.

436701 Kanguro Ø 55 cm. anti-explosión. - Kangaroo Ø 55 cm. No-burst.



436 500 Asiento saltarín. - Jumper seat.

PSICOMOTRICIDAD - PSYCOMOVEMENT

## FITNESS BALL TECNOCAUCHO PRO

Los Fitness balls Tecno Caucho PRO de Amaya Sport son los Balones de fitness más avanzados tecnológicamente del mercado. De gran resistencia a la abrasión y con máxima elasticidad, aportan una mayor durabilidad y un extra de seguridad a los usuarios. Es el balón elegido por los profesionales de Fitness y Pilates, Entrenamiento Funcional y rehabilitación. Soportan más de 1000 kg (ensayos realizados en laboratorio). Material de sistema molecular amorfo, por lo que en el hipotético caso de pinchazo, se deshincha lentamente. Fabricados en España con materiales eco-friendly acordes a las normativas Europeas de seguridad, salubridad y medio ambiente. 100% reciclable. Colores Azul, Gris, Grafito, Verde y Fucsia. *Tecnocaucho PRO Fitness balls by Amaya Sport are the most technologically advanced fitness balls on the market. Highly resistant to abrasion and maximum elasticity, they provide greater durability and extra safety for users. It is the ball chosen by the professionals of Fitness and Pilates, Functional Training and rehabilitation.*

*They support more than 1000 kg (laboratory tests). Material of amorphous molecular system, so in the hypothetical case of puncture, it slowly deflates. Manufactured in Spain with eco-friendly materials in accordance with European safety, health and environmental regulations. 100% recyclable. Blue, Gray, Graphite, Green and Fuchsia colors.*

Fitness Ball Tecno Caucho® Pro 55 cm.

- 50005010 - Fucsia - Fuchsia
- 50005011 - Azulón - Deep blue
- 50005014 - Plata - Silver
- 50005016 - Turquesa - Turquoise
- 50005018 - Verde - Green
- 50005030 - Grafito - Graphite

Fitness Ball Tecno Caucho® Pro 65 cm.

- 50005110 - Fucsia - Fuchsia
- 50005111 - Azulón - Deep blue
- 50005114 - Plata - Silver
- 50005116 - Turquesa - Turquoise
- 50005118 - Verde - Green
- 50005130 - Grafito - Graphite

Fitness Ball Tecno Caucho® Pro 75 cm.

- 50005210 - Fucsia - Fuchsia
- 50005211 - Azulón - Deep blue
- 50005214 - Plata - Silver
- 50005216 - Turquesa - Turquoise
- 50005218 - Verde - Green
- 50005230 - Grafito - Graphite



## FITNESS BALL TECNOCAUCHO LITE

El Fitness ball Tecno Caucho LITE es un balón ligero. Es el balón elegido por los profesionales que buscan un producto económico y de alta calidad. Fabricado en Tecno Caucho, lo que le da una gran resistencia a la abrasión y una máxima elasticidad, que aportan una mayor durabilidad y un extra de seguridad a los usuarios.

Es el balón elegido por los usuarios que buscan un producto económico y de alta calidad. Soportan más de 600 kg (ensayos realizados en laboratorio). Material de sistema molecular amorfo, por lo que en el hipotético caso de pinchazo, se deshincha lentamente. Fabricados en España con materiales eco-friendly acordes a las normativas Europeas de seguridad, salubridad y medio ambiente. 100% reciclable. Colores Azul, Gris, Grafito, Verde y Fucsia.

*The Tecno Caucho LITE Fitness ball is a light ball. It is the ball chosen by professionals looking for an economical and high quality product. Manufactured in Tecno Caucho, which gives it great abrasion resistance and maximum elasticity and provide greater durability and extra safety for users. It is the ball chosen by users looking for an economical and high quality product. They support more than 600 kg (laboratory tests). Material of amorphous molecular system, so in the hypothetical case of puncture, it slowly deflates. Manufactured in Spain.*

Fitness Ball Tecno Caucho® LITE 45 cm

- 51090010 - Fucsia - Fuchsia
- 51090011 - Azulón - Deep blue
- 51090014 - Plata - Silver
- 51090016 - Turquesa - Turquoise
- 51090018 - Verde - Green
- 51090030 - Grafito - Graphite

Fitness Ball Tecno Caucho® LITE 55 cm

- 51091010 - Fucsia - Fuchsia
- 51091011 - Azulón - Deep blue
- 51091014 - Plata - Silver
- 51091016 - Turquesa - Turquoise
- 51091018 - Verde - Green
- 51091030 - Grafito - Graphite

Fitness Ball Tecno Caucho® LITE 65 cm

- 51092010 - Fucsia - Fuchsia
- 51092011 - Azulón - Deep blue
- 51092014 - Plata - Silver
- 51092016 - Turquesa - Turquoise
- 51092018 - Verde - Green
- 51092030 - Grafito - Graphite





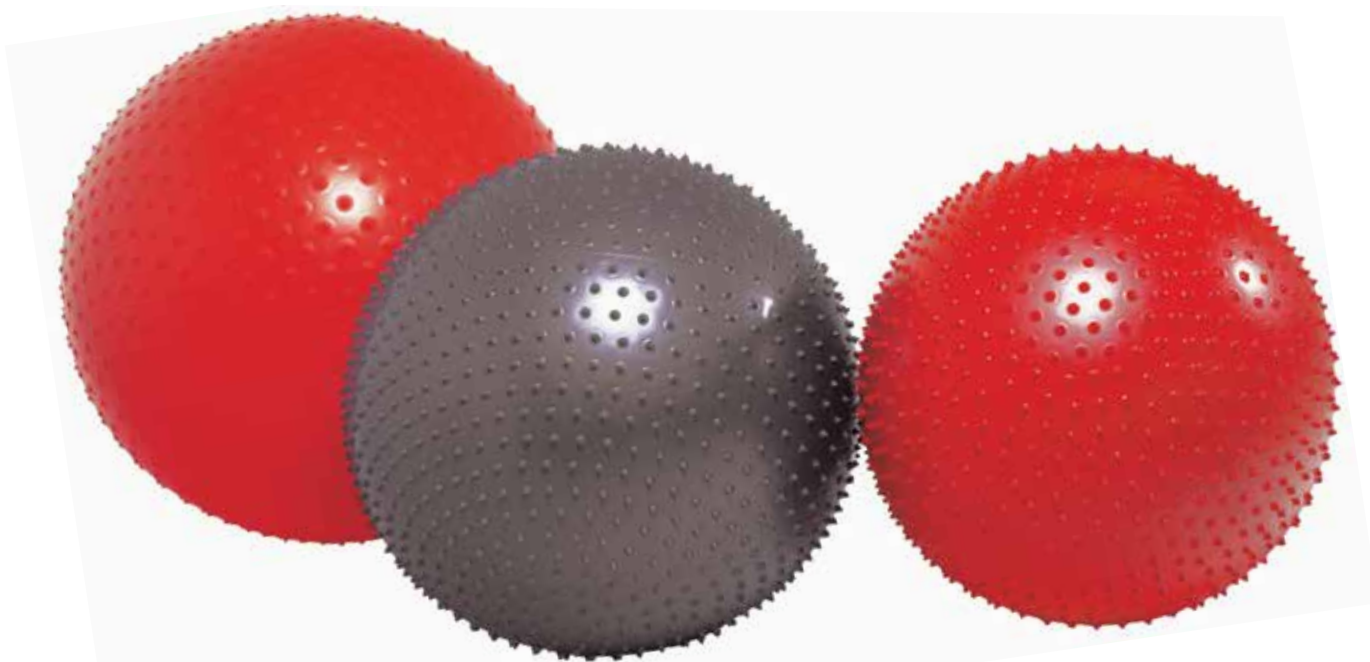

**PELOTÓN SENSORIAL**

**530 555** Pelotón sensorial superficie pinchos Ø 55 cm. - *Sensorial ball with spiky surface Ø 55 cm.*

**530 565** Pelotón sensorial superficie pinchos Ø 65 cm. - *Sensorial ball with spiky surface Ø 65 cm.*

**530 575** Pelotón sensorial superficie pinchos Ø 75 cm. - *Sensorial ball with spiky surface Ø 75 cm.*



**PELOTÓN T.P.E.** para gimnasia, fabricados en materiales nuevos, más ligeros y resistentes.

Gran mejora en las prestaciones en comparación a la formulación original.

El Test de resistencia al estallido por compresión ensayado en la máquina europea estándar INSTRON, determina que soportan un peso superior a los 1000 Kg. en condiciones normales.

*New big balls for aerobic and gymnastic, made in new materials, lighter and more resistant.*

*Improvement in performance qualities in comparison with original formulation.*

*The bursting resistance under compression test made by the european standard INSTRON, machine states that the big balls support a weight superior a 1000 Kg. in average conditions.*

**510 201** Pelotones TPE "fitness ball" anti-explósión, gimnasia y terapia medicinal Ø 55 cm.  
*TPE balls for aerobic, gymnastics and medicinal therapy Ø 55 cm.*

**510 301** Pelotones TPE "fitness ball" anti-explósión, gimnasia y terapia medicinal Ø 65 cm.  
*TPE balls for aerobic, gymnastics and medicinal therapy Ø 65 cm.*

**510 401** Pelotones TPE "fitness ball" anti-explósión, gimnasia y terapia medicinal Ø 75 cm.  
*TPE balls for aerobic, gymnastics and medicinal therapy Ø 75 cm.*

**510 501** Pelotones TPE "fitness ball" anti-explósión, gimnasia y terapia medicinal Ø 85 cm.  
*TPE balls for aerobic, gymnastics and medicinal therapy Ø 85 cm.*

**510 601** Pelotones TPE "fitness ball" anti-explósión, gimnasia y terapia medicinal Ø 95 cm.  
*TPE balls for aerobic, gymnastics and medicinal therapy Ø 95 cm.*

**510 651** Pelotones TPE "fitness ball" anti-explósión, gimnasia y terapia medicinal Ø 120 cm.  
*TPE balls for aerobic, gymnastics and medicinal therapy Ø 120 cm.*



# BIG-BALL

OFICIAL SIZE & WEIGHT



PSICOMOTRICIDAD - PSYCOMOVEMENT

Pelota para la práctica del KIN-BALL. Tiene un tamaño de 1,22 metros de diámetro y 1 Kg de peso. Fabricada en un nylon muy resistente con doble cosido. Vejiga especial de látex natural.

Se juega con tres equipos de cuatro jugadores en una superficie de 20 x 20 m. El objetivo del juego consiste en atrapar y controlar la pelota antes de que esta toque el suelo.

Valores del Juego:

Admite equipos mixtos e integra ciertos valores sociales muy positivos:

- Elimina el individualismo: un jugador solo puede destacar con el apoyo del resto del equipo.
- Fomenta el respeto hacia los demás.
- Promueve la integración a un grupo: infunde cooperación y espíritu de equipo.
- Estimula el desarrollo social y cognitivo: ningún equipo domina sobre los otros, todos tienen las mismas oportunidades.
- Permite desarrollar habilidades físicas y mentales: cada jugador aporta los conocimientos que adquiere durante los partidos y los entrenamientos con el fin de mejorar el rendimiento del grupo y los resultados. La técnica se va perfeccionando con la práctica. Se trata de encontrar los puntos fuertes de cada equipo para obtener los mejores resultados.

*Ball to practise KIN-BALL, with 122 cm diameter size and 1 kg weight. Made of very resistant nylon, double sewed, and special bladder of natural latex. To play should be 3 teams, of 4 persons each one, on a 20 x 20 mt. area.*

*The game purpose is to catch and control the ball, before it touches the floor.*

Game values :

- Allow mixed teams, giving so positive social values.
- Suppress the individualism : one single player only could stands out with the support of the rest of the team.
- Promote the respect of the others.
- Useful for integration to one group : infuses cooperation and team spirit.
- Spurs social and cognitive develop : any team can dominate over the rest. All of them have the same opportunities.
- Develope physical and mental skills: each player contributes with the acquired knowledge during the matches and trainings, with a view to increase the efficiency and results. The team should find the strenghts of each player, and practice to improve the weak points of the group as a whole.





## BIG-BALL

**51002007** BIG BALL 122 cm. Rojo / Red  
**51002011** BIG BALL 122 cm. Azul / Blue  
**51002014** BIG BALL 122 cm. Gris / Grey  
**51002100** Cámara de recambio Big Ball 122 cm.  
*Replacement bladder Big Ball 122 cm*

**51002207** BIG BALL 90 cm. Rojo / Red  
**51002211** BIG BALL 90 cm. Azull / Blue  
**51002214** BIG BALL 90 cm. Gris / Grey  
**51002300** Cámara de recambio Big Ball 90 cm.  
*Replacement bladder Big Ball 90 cm*

**51002407** BIG BALL 75 cm. Rojo / Red  
**51002411** BIG BALL 75 cm. Azull / Blue  
**51002414** BIG BALL 75 cm. Gris / Grey  
**51002500** Cámara de recambio Big Ball 75 cm.  
*Replacement bladder Big Ball 75 cm*

**51002607** BIG BALL 60 cm. Rojo / Red  
**51002611** BIG BALL 60 cm. Azul / Blue  
**51002614** BIG BALL 60 cm. Gris / Grey  
**51002700** Cámara de recambio Big Ball 60 cm.  
*Replacement bladder Big Ball 60 cm*

**51002807** BIG BALL 45 cm. Rojo / Red  
**51002811** BIG BALL 45 cm. Azull / Blue  
**51002814** BIG BALL 45 cm. Gris / Grey  
**51002900** Cámara de recambio Big Ball 45 cm.  
*Replacement bladder Big Ball 45 cm*





## PELOTÓN FLOTANTE NYLON

510 040 Pelotón flotante nylon Ø 45 cm. Cámara interior de látex. - Air floating nylon ball Ø 45 cm. Inner látex bladder.

510 050 Pelotón flotante nylon Ø 60 cm. Cámara interior de látex. - Air floating nylon ball Ø 60 cm. Inner látex bladder.

510 060 Pelotón flotante nylon Ø 75 cm. Cámara interior de látex. - Air floating nylon ball Ø 70 cm. Inner látex bladder.

510 065 Pelotón flotante nylon Ø 90 cm. Cámara interior de látex. - Air floating nylon ball Ø 90 cm. Inner látex bladder.

510 070 Pelotón flotante nylon Ø 120 cm. Cámara interior de látex. - Air floating nylon ball Ø 120 cm. Inner látex bladder.



## 437 102 KICKING BALL

Diámetro - 210 mm. - Diameter - 210 mm.



**437 100 SKIPIBALL**

Cabeza de termoplástico con satélite en poliestireno resistente, diámetro 37 cm. Altura de apoyo 15 cm.

*Thermoplastic head with Polyestiren basement, very resistant, with 37 cm diameter and 15 cm height.*



**437 001 CILINDRO CACAHUET**

75 cm longitud.

*Peanut cylinder, 75 cm. length.*



**437 000 CILINDRO**

75 cm longitud. - *Cylinder 75 cm. length.*



**437 002 CILINDRO INFANTIL** 42 cm longitud.

*Children's cylinder, 42 cm length.*

PSICOMOTRICIDAD - PSYCOMOEMENT



**70022600** BALON FUTBOL NEW TEAM.

Fabricado en termoplástico. Peso 180 g. Diámetro 21 cm. Colores surtidos.

*Team Football Team. Made in Thermoplastic. Weight 180 g. Diameter 21 cm.*

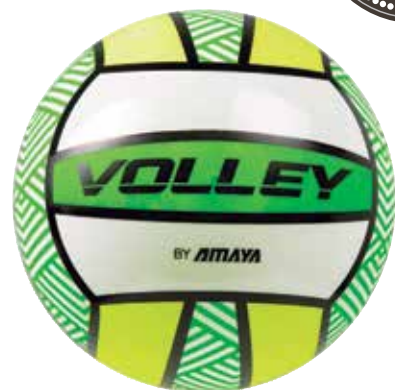
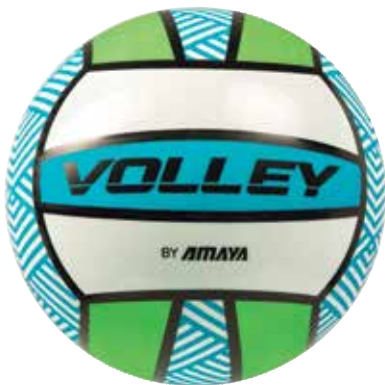

**70022800** BALÓN VOLLEY PLAYA DECORADO. Fabricado en termoplástico.

Peso 180 g. Diámetro 21 cm. Colores surtidos.

*Beach Volley. Made in Thermoplastic. Weight 180 g. Diameter 21 cm.*



**700 30 500** BALÓN DECORADO RAINBOW. Fabricado en termoplástico. Peso 180 g.

Diámetro 21 cm. Colores surtidos.

*Rainbow ball. Made in Thermoplastic. Weight 180 g. Diameter 21 cm.*





**PELOTA LISA TERMOPLÁSTICO / PLAIN THERMOPLASTIC BALL**

464 800 Tamaño/ Size Ø 140 mm.  
464 900 Tamaño/ Size Ø 180 mm.  
465 000 Tamaño/ Size Ø 220 mm.

**PELOTA RUGOSA TERMOPLÁSTICO / RUGGED THERMOPLASTIC BALL**

465 100 Tamaño/ Size Ø 140 mm.  
465 200 Tamaño/ Size Ø 180 mm.  
465 300 Tamaño/ Size Ø 220 mm.



**PELOTA RUGOSA TERMOPLÁSTICO DECORADA  
RUGGED PRINTED THERMOPLASTIC BALL**

465 400 Tamaño/ Size Ø 140 mm.  
465 500 Tamaño/ Size Ø 180 mm.  
465 600 Tamaño/ Size Ø 220 mm.



**PELOTA RELIEVE TERMOPLÁSTICO / GROOVED THERMOPLASTIC BALL**

464 400 Tamaño/ Size Ø 100 mm.  
464 500 Tamaño/ Size Ø 140 mm.  
464 600 Tamaño/ Size Ø 180 mm.  
464 700 Tamaño/ Size Ø 220 mm.



**PELOTA PERFORADA CON CASCABEL / EVA BALL WITH HOLES AND BELL**

466 101 Tamaño/ Size Ø 120 mm.  
466 102 Tamaño/ Size Ø 160 mm.



**PELOTA RUGOSA CAUCHO CELULAR  
RUGGED RUBBER BALL**

466 200 Tamaño/ Size Ø 220 mm.  
466 300 Tamaño/ Size Ø 180 mm.  
466 400 Tamaño/ Size Ø 140 mm.



**43989800** Figuras piscina Corazón - Estrella. Caja 500 corazones + 500 estrellas  
 Novedosas figuras para playgrounds en las que las formas toman protagonismo, dejando de lado las bolas tradicionales. Medidas 6 cm.  
**43989900** Heart-Star pool figures. Box 500 hearts + 500 stars.  
 Brand new shapes for playgrounds, leaving aside the traditional balls. Measures 6 cm.



Pelotas piscina Fabricadas en polietileno con aditivos especiales para aumentar la resistencia a la fricción. Colores rojo, amarillo, azul, verde, rosa y naranja.

**439 900** Pelotas llenado de piscina Ø 75 mm. caja de 600 unidades en 6 colores.  
 Balls for pool Ø 75 mm. 6 colors.

**439 910** Pelotas llenado de piscina Ø 75 mm. bolsa de 500 unidades 1 color.  
 Balls for pool Ø 75 mm. 1 color.



**439 905** 100 pelotas piscina. Diámetro 75 mm.  
 Bolsa de 100 unidades en 6 colores.

100 pool balls. Diam. 75 mm. colours: red, yellow, blue, green, pink, orange. From 0 years on



**439 871** Pieza recta inferior, alt. 25 cm. Longitud. 60 cm.  
 Single lower straight piece. 25 cm. 60 cm. length.



**439 815** Pieza curva inferior de piscina, alt. 25 cm. Longitud. 60 cm.  
 Single module for sensorial pool, height 25 cm. 60 cm. length.



**439 876** Pieza esquina superior, alt. 30 cm..  
 Single upper corner. 30 cm.



**439 875** Pieza esquina inferior, alt. 25 cm.  
 Single lower corner. 25 cm.



**439 850** Pieza curva superior de piscina, altura 30 cm. Longitud. 60 cm.  
 Single module for sensorial pool, height 30 cm. 60 cm. length.



**439 872** Pieza recta superior, alt. 30 cm. Longitud. 60 cm.  
 Single upper straight piece. 30 cm. 60 cm. length.





**439 810** Piscina sensorial multiforma en forma de ocho abierto, altura 52 cm. Pelotas no incluidas.  
*Sensorial pool (peanut form), height 52 cm. Balls not included.*

**439 840** Piscina sensorial multiforma en forma de ocho abierto, altura 30 cm. Compuesta por 16 módulos. Pelotas no incluidas.  
*Sensorial pool (peanut form), height 30 cm., 16 modules. Balls not included.*



**439 865** Piscina sensorial en cruz, 2 x 2 m. Altura 52 cm. Pelotas no incluidas.  
*Sensorial pool in cross 2 x 2 m. height 52 cm. Balls not included.*



**439 830** Piscina sensorial redonda, Ø interior 1,50 m. altura 30 cm. Pelotas no incluidas.  
*Sensorial round pool, Ø 1,50 m., height 30 cm. Balls not included.*



**439 800** Piscina sensorial redonda, Ø interior 1,50 m. altura 52 cm. Pelotas no incluidas.  
*Sensorial round pool, Ø 1,50 m., height 52 cm. Balls not included.*



**439 710** Piscina arena cuadrada 152 x 152 x 25 cm.  
*Square pool for sand exterior 152 x 152 x 25 cm.*



**439 870** Parque infantil cuadrado, interior 130 x 130 cm. Altura 52 cm.  
*Square playground, inner 130 x 130 cm. height 52 cm.*



**439 700** Piscina para arena, Ø interior 1,50 m., altura 25 cm.  
*Sensorial pool for sand, Ø 1,50 m., height 25 cm.*



**437 430** Piscina de juegos, parque de nylon. No incluye pelotas de piscina. Diámetro: 135 cm. Altura: 60 cm.  
*Play pool - park made of nylon. Not including pool balls. Diameter: 135 cm. Height: 60 cm.*

PISCINAS SENSORIALES - SENSORIAL POOLS



Fabricado en P.U. espumado. Piezas para ser utilizadas en interiores con suelos lisos.  
 Manufactured in foamed P.U. Parts to use indoors with smooth floors.



**450 050** Figuras de equilibrio, set de 4 figuras diferentes.  
 Set 4 balancing figures.



**442 806** Juego manos y pies foam, set de 8 piezas.  
 Foam hands and feet game. Set of 8 pieces.



**455 001** Dado Foam de 20 x 20 cm. - Foam dice 20 x 20 cm.



**443 902** Espada foam- Foam sword.



**442 700** Set de bolos foam. - Foam bowling.



**455 000** Set de bolos foam recubierto - Coated foam bowling.

# BALONES DE FOAM - FOAM BALLS

PELOTAS Y FIGURAS DE FOAM Y FOAM RECUBIERTO - FOAM AND COATED FOAM BALLS AND FIGURES



**443 100** Pelota Ø 210 mm. Peso: 270 gr. Apto para volley oficial, fútbol y juegos diversos.  
*Ball 210 Ø mm. Weight: 270 gr. Suitable for official volley, football and multiple games.*

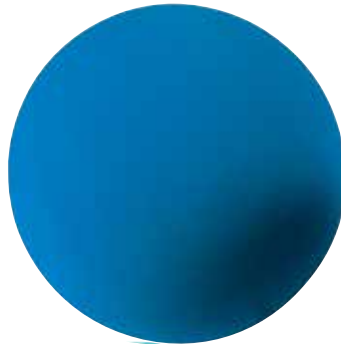

**443 200** Pelota Ø 190 mm. Peso: 225 gr. Apto para mini-volley, fútbol nº3, mini-basket y juegos diversos.  
*Ball Ø 190 mm. Weight: 225 gr. Suitable for mini-volley, football nº 3, mini-basket and multiple games.*



**443 600** Pelota Ø 160 mm. Peso: 120 gr. Apto para mini-balónmano y juegos diversos.  
*Ball Ø 160 mm. Weight: 120 gr. Suitable for mini-handball and multiple games.*



**443 700** Pelota Ø 130 mm. Peso: 70 gr. Apto para juegos de mano.  
*Ball Ø 130 mm. Weight: 70 gr. Suitable for hand games.*



**443 930** Pelota foam ligero Ø 210 mm. Peso ≈ 229 g.  
*Light Foam ball Ø 210 mm. Weight ≈ 229 g.*



**443 932** Pelota foam ligero Ø 190 mm. Peso ≈ 189 g.  
*Light Foam ball Ø 190 mm. Weight ≈ 189 g.*



**443 934** Pelota foam ligero Ø 160mm. Peso ≈ 102 g.  
*Light Foam ball Ø 160 mm. Weight ≈ 102 g.*



**443 800** Pelota Ø 95 mm. Peso: 30 gr. Apto para juegos de mano y raqueta.



**443 900** Pelota Ø 70 mm. Peso: 15 gr. Apto para juegos de raqueta, pala y juegos diversos.





**454 000** Foam recubierto piel  
Ø 210 mm. Peso: 304 gr.  
Coated foam ball Ø 210 mm.  
Weight: 304 gr.



**454 100** Foam recubierto piel Ø 190 mm. Peso: 255 gr.  
Coated foam ball Ø 190 mm. Weight: 255 gr.



**454 200** Foam recubierto piel Ø 160 mm. Peso: 136 gr.  
Coated foam ball Ø 160 mm.  
Weight: 136 gr.



**455 010** Pelota foam recubierto ligero  
Ø 210 mm.  
Light Coated Foam ball Ø 210 mm.



**455 012** Pelota foam recubierto ligero Ø 190 mm.  
Light Coated Foam ball Ø 190 mm.



**455 014** Pelota foam recubierto ligero Ø 160 mm.  
Light Coated Foam ball Ø 160 mm.



**454 500**



**454 300**

**454 400**

**454 300** Foam recubierto piel Ø 130 mm. Peso: 80 gr.  
Coated foam ball Ø 130 mm. Weight: 80 gr.  
**454 400** Foam recubierto piel Ø 95 mm. Peso: 35 gr.  
Coated foam ball Ø 95 mm. Weight: 35 gr.  
**454 500** Foam recubierto piel Ø 70 mm. Peso: 19 gr.  
Coated foam ball Ø 70 mm. Weight: 19 gr.

Fabricado en poliuretano espumado y recubierto de material plástico muy resistente. Piezas para ser utilizadas en salas interiores con suelos lisos. Sin cremalleras ni objetos punzantes. Lavable. Los niños tienen que utilizar las piezas descalzos.

Made of polyurethane foam and covered with durable plastic material. Parts to use indoors with smooth floors. No zippers or sharp objects. Washable. Children have to use without shoes.



PELOTAS Y FIGURAS DE FOAM Y FOAM RECUBIERTO - FOAM AND COATED FOAM BALLS AND FIGURES



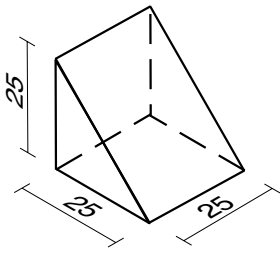

450 010 Figura número 10. - Figure number 10.

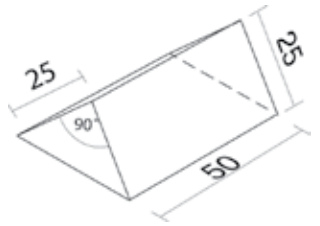

450 011 Figura número 11. - Figure number 11.

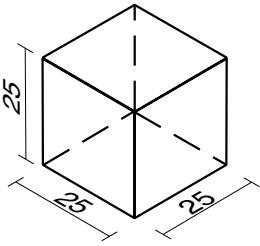

450 012 Figura número 12. - Figure number 12.

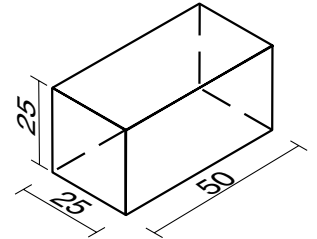

450 013 Figura número 13. - Figure number 13.

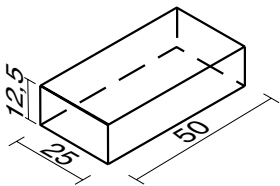

450 014 Figura número 14. - Figure number 14.

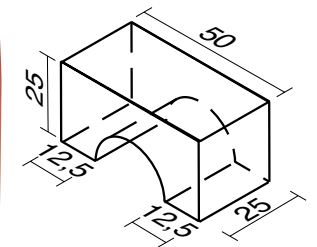

450 015 Figura número 15. - Figure number 15.

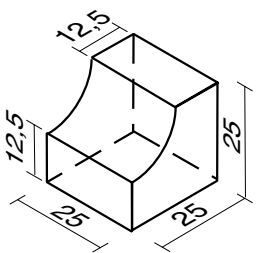

450 016 Figura número 16. - Figure number 16.



450 017 Figura número 17. - Figure number 17.

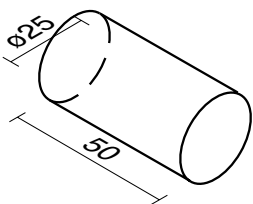
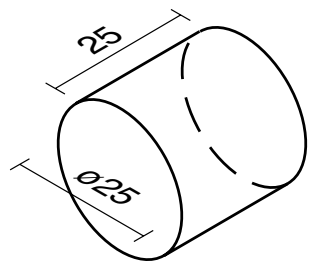

450 018 Figura número 18. - Figure number 18.



450 019 Figura número 19. - Figure number 19.

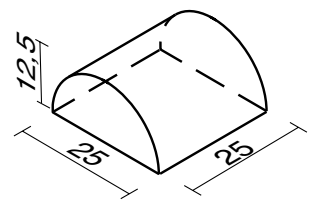

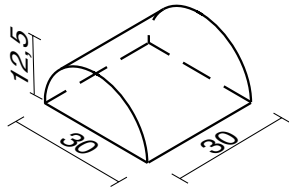

450 020 Figura número 20. - Figure number 20.

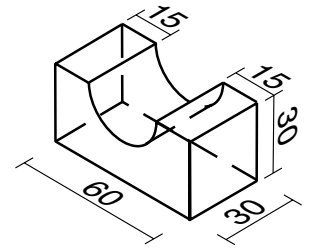

450 023 Figura número 23. - Figure number 23.

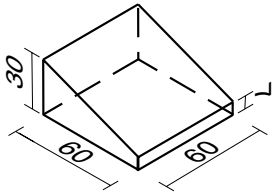

450 025 Figura número 25. - Figure number 25.

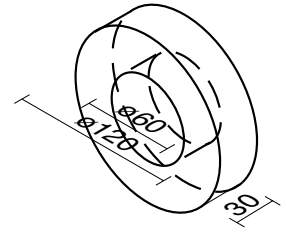

450 027 Figura número 27. - Figure number 27.

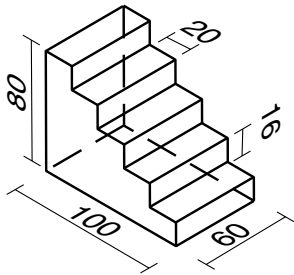

450 035 Figura número 35. - Figure number 35.

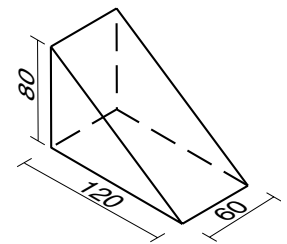
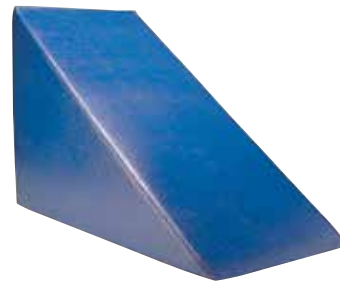

450 036 Figura número 36. - Figure number 36.

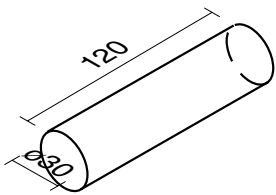

450 039 Figura número 39. - Figure number 39.

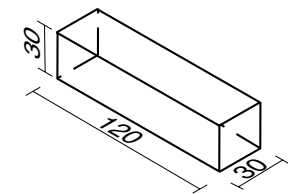

450 040 Figura número 40. - Figure number 40.

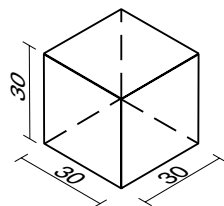

450 043 Figura número 43. - Figure number 43.



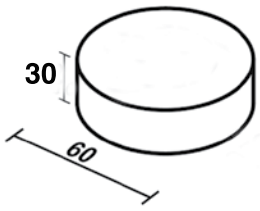

580 030 Figura número 46. - Figure number 46.

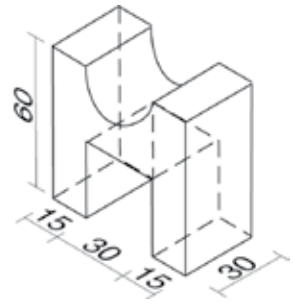

450 045 Figura número 45. - Figure number 45.

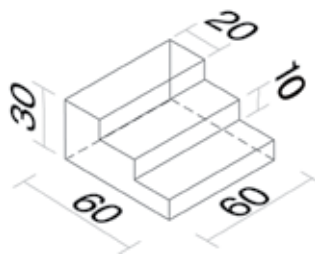

450 051 Figura número 51. - Figure number 51.

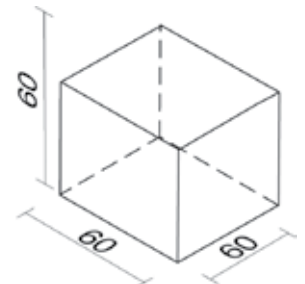

450 047 Figura número 47. - Figure number 47.

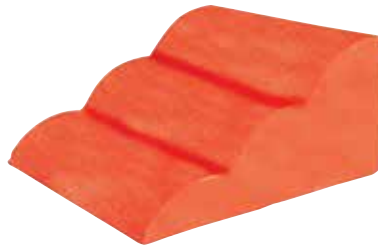
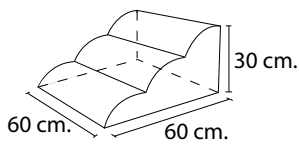

450 021 Figura número 21. - Figure number 21.

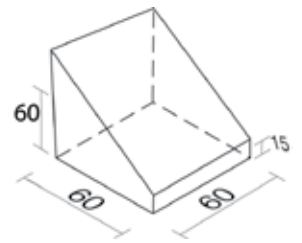

450 049 Figura número 49. - Figure number 49.

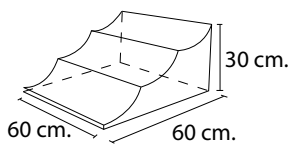

450 024 Figura número 24. - Figure number 24.

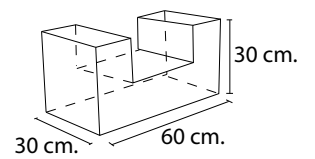
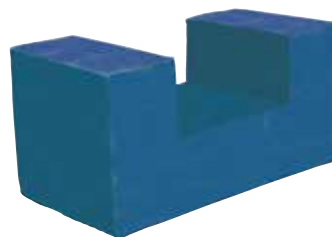

450 022 Figura número 22. - Figure number 22.

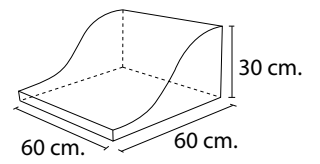
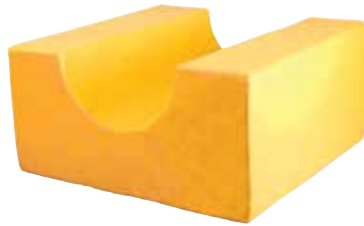
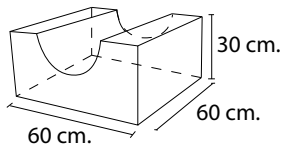

450 028 Figura número 28. - Figure number 28.

450 029 Figura número 29. - Figure number 29.

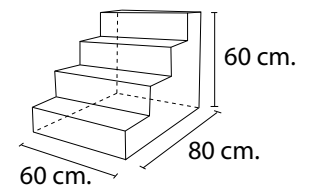
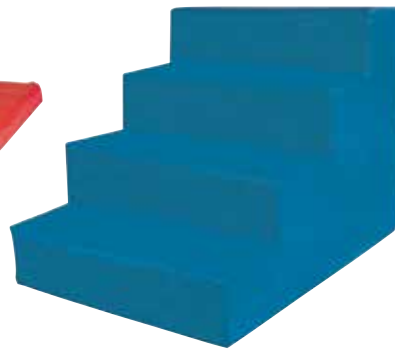
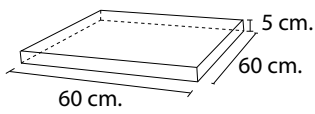

450 030 Figura número 30. - Figure number 30.

450 031 Figura número 31. - Figure number 31.

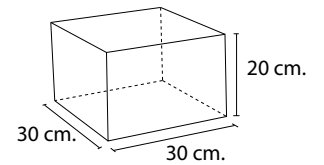
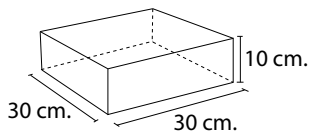

450 032 Figura número 32. - Figure number 32.

450 033 Figura número 33. - Figure number 33.

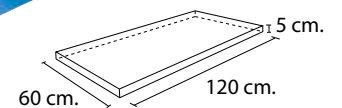
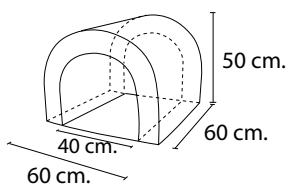

450 034 Figura número 34. - Figure number 34.

450 042 Figura número 42. - Figure number 42.



**450 053 CONJUNTO DE PIEZAS RECUBIERTAS CON CUERO SINTÉTICO.**

Caja con 22 piezas. Fabricadas en poliuretano espumado y recubierto de cuero sintético muy resistente. Piezas para ser utilizadas en salas interiores con suelos lisos. Sin cremalleras ni objetos punzantes. Lavable. Los niños tienen que utilizar las piezas descalzos. Nuevo sistema de cosido.

*Set of synthetic leather coated foam figures. Box of 22 pieces. Made of polyurethane foam and covered with high resistance synthetic leather. Parts for use indoors with flat floors. No zippers or sharp objects. Washable. Kids have to use without shoes. New sewing system.*



PELOTAS Y FIGURAS DE FOAM Y FOAM RECUBIERTO - FOAM AND COATED FOAM BALLS AND FIGURES

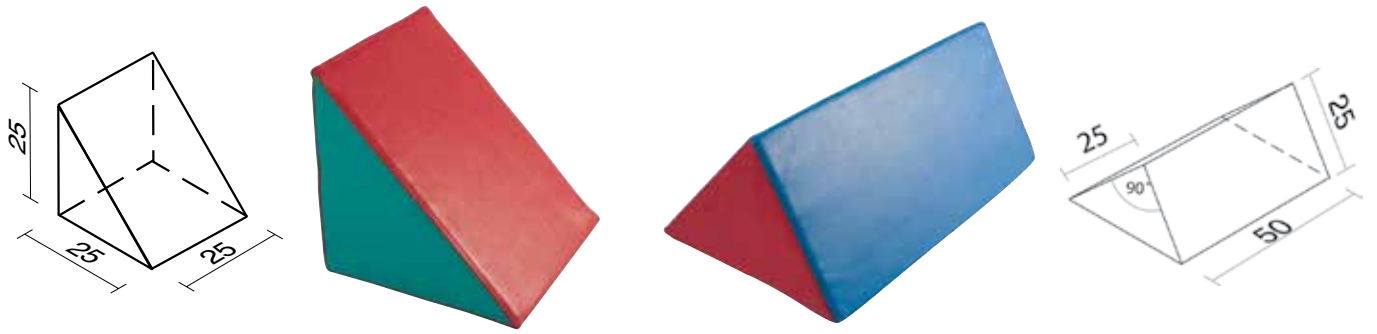

450 054 Figura número 54. - Figure number 54.

450 055 Figura número 55. - Figure number 55.

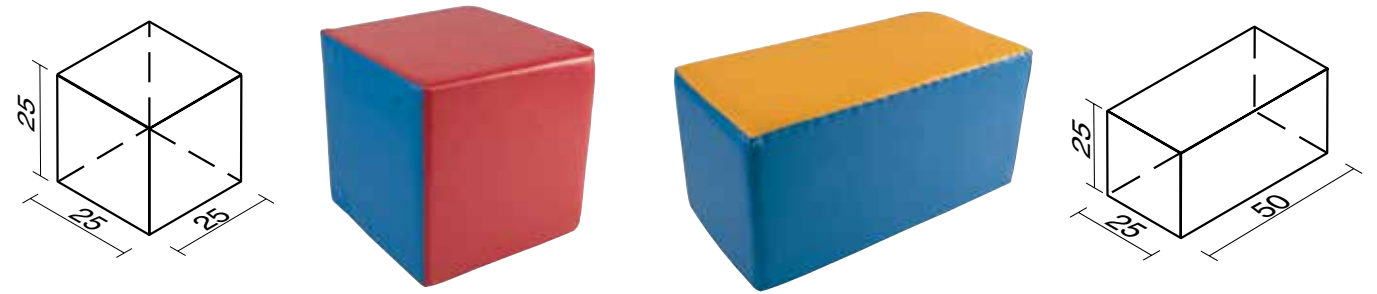

450 056 Figura número 56. - Figure number 56.

450 057 Figura número 57. - Figure number 57.

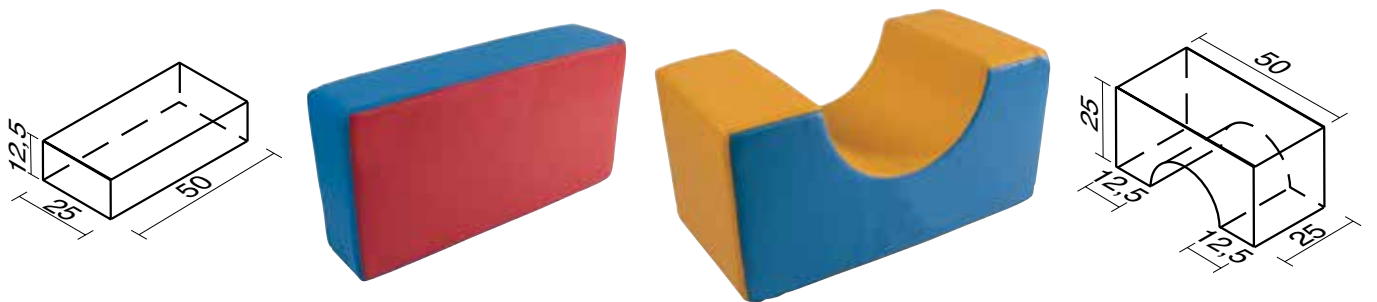

450 058 Figura número 58. - Figure number 58.

450 059 Figura número 59. - Figure number 59.



450 060 Figura número 60. - Figure number 60.

450 061 Figura número 61. - Figure number 61.

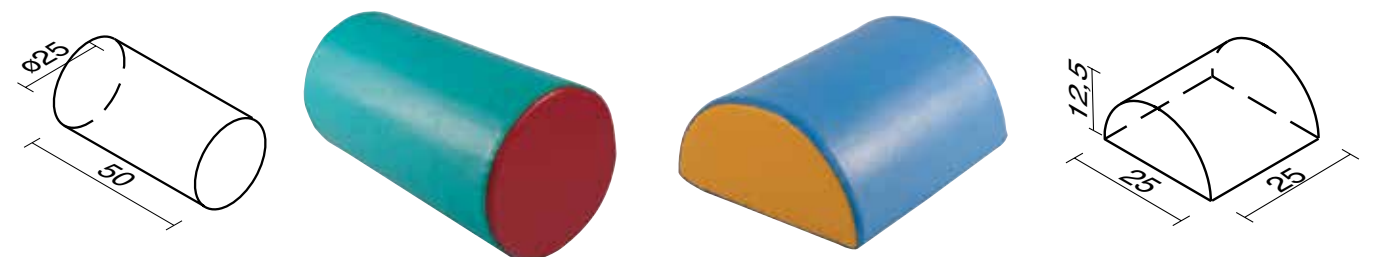

450 062 Figura número 62. - Figure number 62.

450 063 Figura número 63. - Figure number 63.



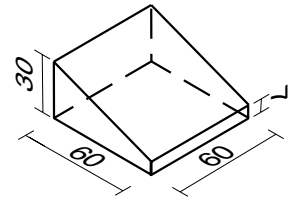
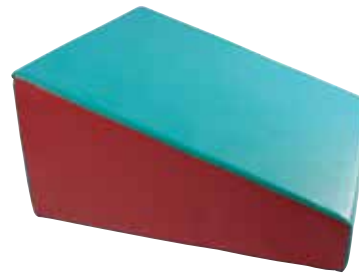
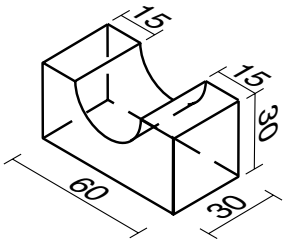

450 077 Figura número 77. - Figure number 77.

450 068 Figura número 68. - Figure number 68.

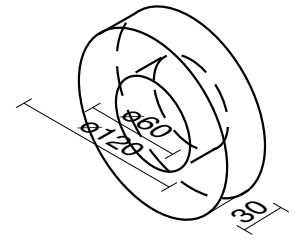
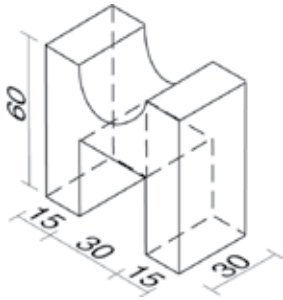

450 067 Figura número 67. - Figure number 67.

450 070 Figura número 70.- Figure number 70.

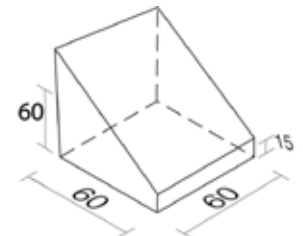
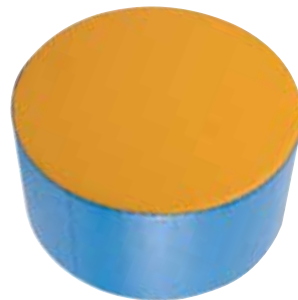
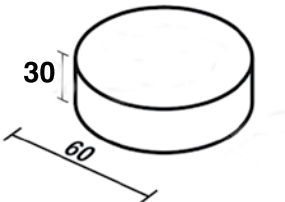

450 069 Figura número 69. - Figure number 69.

450 071 Figura número 71. - Figure number 71.

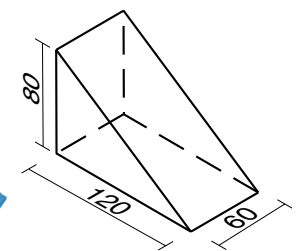
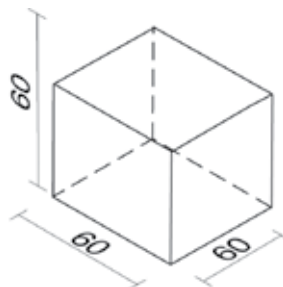

450 066 Figura número 66. - Figure number 66.

450 073 Figura número 73. - Figure number 73.

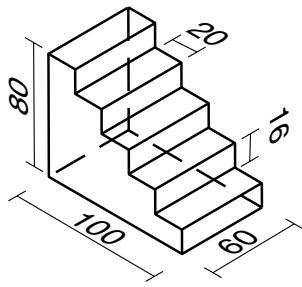

450 074 Figura número 74. - Figure number 74.

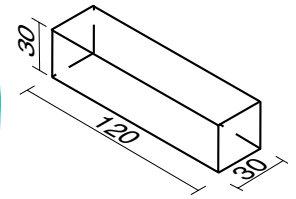
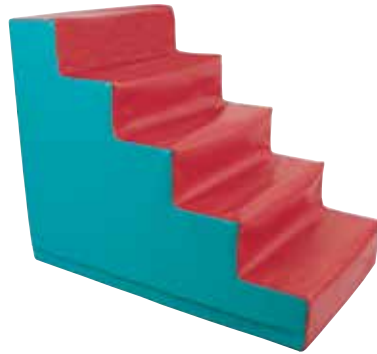

450 075 Figura número 75. - Figure number 75.

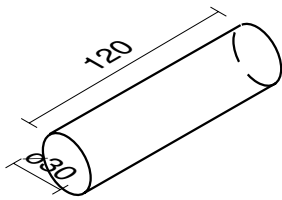

450 078 Figura número 78. - Figure number 78.

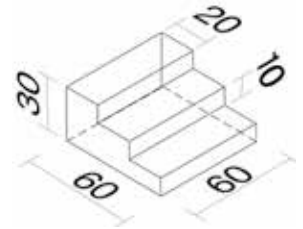

450 076 Figura número 76. - Figure number 76.

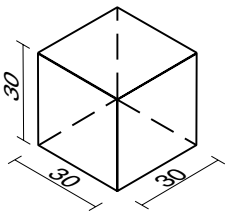

450 079 Figura número 79. - Figure number 79.

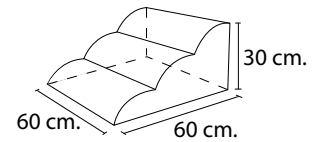

450 080 Figura número 80. - Figure number 80.

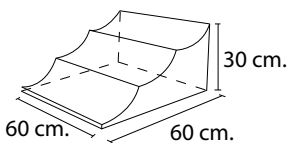

450 081 Figura número 81. - Figure number 81.

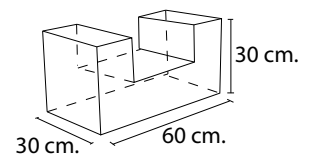
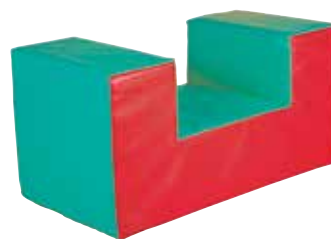

450 082 Figura número 82. - Figure number 82.



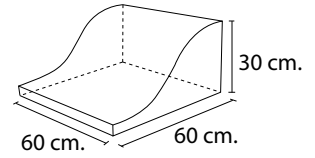
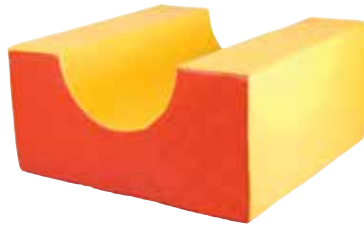
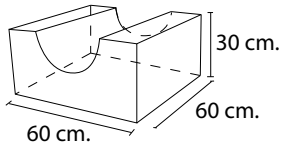

450 083 Figura número 83. - Figure number 83.

450 084 Figura número 84. - Figure number 84.

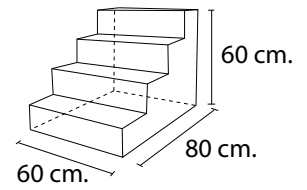
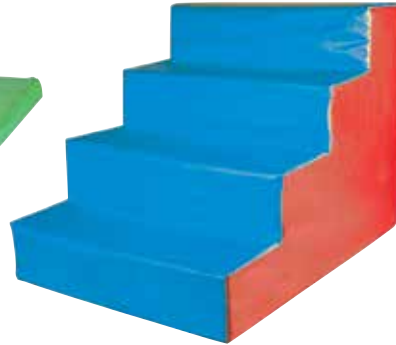
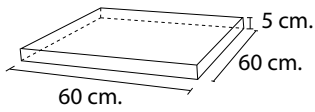

450 085 Figura número 85. - Figure number 85.

450 086 Figura número 86. - Figure number 86.

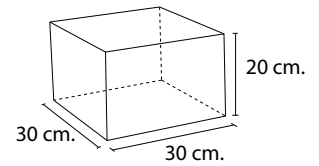
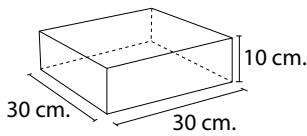

450 087 Figura número 87. - Figure number 87.

450 088 Figura número 88. - Figure number 88.

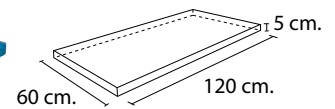
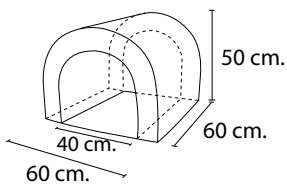

450 089 Figura número 89. - Figure number 89.

450 090 Figura número 90. - Figure number 90.

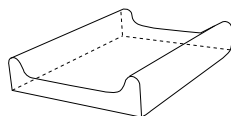

450 092 Figura número 92. Cambiador bebé. Medidas: 60 x 60 cm. Altura lateral: 15 cm. Altura central: 7 cm.  
Figure number 92. Baby changer. Meassure: 60 x 60 cm. Lateral height 15 cm. Central height 7 cm.



**450 105** Set de dos figuras recubiertas en piel. 30 cm. de altura.  
 Compuesto por figuras 21 + 24.  
*Set of two coated foam figures. 30 cm. high.*  
*Composed by figures 21 + 24.*

**460 200** Set de dos figuras recubiertas con lona. 30 cm. de altura.  
 Compuesto por figuras 80 + 81.  
*Set of two leather coated foam figures. 30 cm. high.*  
*Composed by figures 80 + 81.*



**450 110** Set de dos figuras recubiertas en piel. 30 cm. de altura.  
 Compuesto por figuras 51 + 21.  
*Set of two coated foam figures. 30 cm. high.*  
*Composed by figures 51 + 21.*

**460 205** Set de dos figuras recubiertas con lona. 30 cm. de altura.  
 Compuesto por figuras 76 + 80.  
*Set of two leather coated foam figures. 30 cm. high.*  
*Composed by figures 80 + 76.*



**450 120** Set de tres figuras recubiertas en piel. 30 cm. de altura.  
 Compuesto por figuras 40 + 22 (x2).  
*Set of three coated foam figures. 30 cm. high.*  
*Composed by figures 40 + 22 (x2).*

**460 210** Set de tres figuras recubiertas con lona. 30 cm. de altura.  
 Compuesto por figuras 75 + 82(x2).  
*Set of three leather coated foam figures. 30 cm. high.*  
*Composed by figures 75 + 82(x2).*



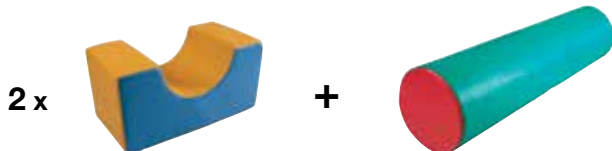
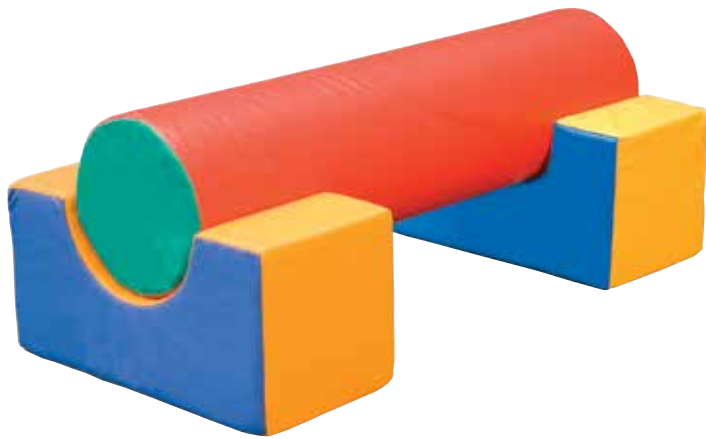

**450 115** Set de tres figuras recubiertas en piel. 30 cm. de altura.

Compuesto por figuras 39 + 23 (x2).

Set of three coated foam figures. 30 cm. high.

Composed by figures 39 + 23 (x2).

**460 215** Set de tres figuras recubiertas con lona. 30 cm. de altura.

Compuesto por figuras 78 + 77 (x2).

Set of three leather coated foam figures. 30 cm. high.

Composed by figures 78 + 77 (x2).

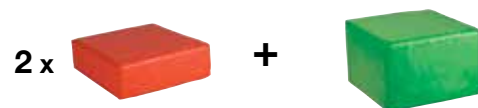

**450 125** Set de tres figuras recubiertas en piel. 20 y 30 cm. de altura.

Compuesto por figuras 43 + 33 (x2).

Set of three coated foam figures. 20 and 30 cm. high.

Composed by figures 43 + 33 (x2).

**460 220** Set de tres figuras recubiertas con lona. 20 y 30 cm. de altura.

Compuesto por figuras 79 + 88 (x2).

Set of three leather coated foam figures. 20 and 30 cm. high.

Composed by figures 79 + 88 (x2).



**450 100** Set de cinco figuras recubiertas en piel. 10, 20 y 30 cm. de altura. Compuesto por figuras 43 + 33 (x2) + 32 (x2).

Set of five coated foam figures. 10, 20 and 30 cm. height. Composed by figures 43 + 33 (x2) + 32 (x2).

**460 225** Set de cinco figuras recubiertas con lona. 10, 20 y 30 cm. de altura. Compuesto por figuras 79 + 88 (x2) + 87 (x2).

Set of five leather coated foam figures. 10, 20 and 30 cm. height. Composed by figures 79 + 88 (x2) + 87 (x2).



**450 140** Set de tres figuras recubiertas en piel. 60 cm. de altura.  
 Compuesto por figuras 40 + 45 (x2).  
*Set of three coated foam figures. 60 cm. high.*  
*Composed by figures 40 + 45 (x2).*

**460 230** Set de tres figuras recubiertas con lona. 60 cm. de altura.  
 Compuesto por figuras 75 + 67 (x2).  
*Set of three leather coated foam figures. 60 cm. high.*  
*Composed by figures 75 + 67 (x2).*

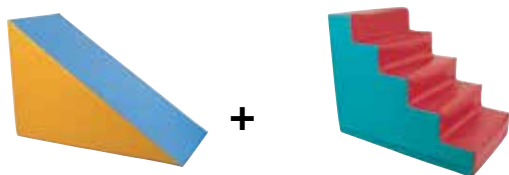

**450 150** Set de dos figuras recubiertas en piel. 80 cm. de altura.  
 Compuesto por figuras 35 + 36.  
*Set of two coated foam figures. 80 cm. high.*  
*Composed by figures 35 + 36.*

**460 235** Set de dos figuras recubiertas con lona. 80 cm. de altura.  
 Compuesto por figuras 73 + 74.  
*Set of two leather coated foam figures. 80 cm. high.*  
*Composed by figures 73 + 74.*

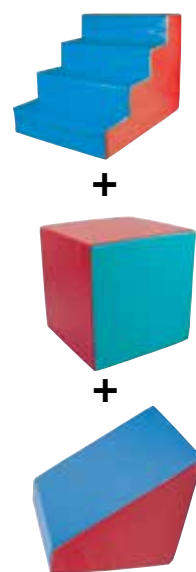

**450 145** Set de tres figuras recubiertas en piel. 60 cm. de altura. Compuesto por figuras 49 + 47 + 31.  
*Set of three coated foam figures. 60 cm. high. Composed by figures 49 + 47 + 31.*

**460 240** Set de tres figuras recubiertas con lona. 60 cm. de altura. Compuesto por figuras 71 + 66 + 86.  
*Set of three leather coated foam figures. 60 cm. high. Composed by figures 71 + 66 + 86.*



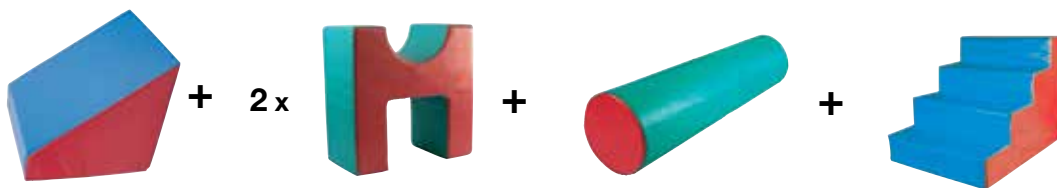

**450 135** Set de cinco figuras recubiertas en piel. 60 cm. de altura. Compuesto por figuras 49 + 45 (x2) + 39 + 31.

*Set of five coated foam figures. 60 cm. high. Composed by figures 49 + 45 (x2) + 39 + 31.*

**460 245** Set de cinco figuras recubiertas con lona. 60 cm. de altura. Compuesto por figuras 71 + 67 (x2) + 78 + 86.

*Set of five leather coated foam figures. 60 cm. high. Composed by figures 71 + 67 (x2) + 78 + 86.*



**450 130** Set de nueve figuras recubiertas en piel. 30 cm. de altura. Compuesto por figuras 30 (x4) + 29 + 76 + 51 + 25 + 28.

*Set of nine coated foam figures. 30 cm. high. Composed by figures 30 (x4) + 29 + 21 + 51 + 25 + 28.*

**460 250** Set de nueve figuras recubiertas con lona. 30 cm. de altura. Compuesto por figuras 68 + 76 + 80 + 83 + 84 + 85 (x4).

*Set of nine leather coated foam figures. 60 cm. high. Composed by figures 68 + 76 + 80 + 83 + 84 + 85 (x4).*



**451 000** Camello foam. Altura cabeza: 428 mm. Altura joroba: 364 mm. Altura lomo: 230 mm. Longitud: 930 mm. Ancho: 250 mm.  
Foam camel. Head height: 428 mm. Hump height: 364 mm. Back height: 230 mm. Length: 930 mm. Wide: 250 mm.



**451 001** Coche foam. Altura ventana: 392 mm. Altura asiento: 205 mm. Longitud: 1 m. Ancho: 250 mm.  
Foam car. Window height: 392 mm. Seat height: 205 mm. Length: 1 m. Wide: 250 mm.



**451 002** Cocodrilo foam. Altura máxima: 210 mm. Longitud: 986 mm. Ancho: 250 mm.  
Foam crocodile. Maximum height: 210 mm. Length: 986 mm. Wide: 250 mm.





**451 004** Gusano foam. Altura cabeza: 480 mm. Altura lomo: 236 mm. Longitud: 995 mm. Ancho: 250 mm.  
Foam worm. Head height: 480 mm. Back height: 236 mm. Length: 995 mm. Wide: 250 mm.



**451 005** Mariquita foam. Altura cabeza: 337 mm. Altura lomo: 274 mm. Longitud: 996 mm. Ancho: 250 mm.  
Foam ladybird. Head height: 337 mm. Back height: 274 mm. Length: 996 mm. Wide: 250 mm.



**451 003** Vaca foam. Altura cabeza: 485 mm. Altura lomo: 230 mm. Longitud: 826 mm. Ancho: 250 mm.  
Foam cow. Head height: 485 mm. Back height: 230 mm. Length: 826 mm. Wide: 250 mm.

## TUBOS MUSICALES.

Cada tubo emite una nota musical al ser golpeado contra el suelo o entre ellos. Fabricados en un material blando y ligero. Perfectamente afinados.

## MUSICAL TUBES.

Musical tubes. Every tube sounds a different musical note when is hitted. Made of soft and light material. Perfectly tuned.



441 042 Tubos diatónicos contraltos. 8 tubos: Do, Re, Mi, Fa, Sol, La, Si y Do. - C major diatonic scale tubes. 8 tubes: C', D', E', F', G', A', B', C".

441 043 Tubos cromáticos contraltos. 5 tubos: Do#, Mib, Fa#, Sol# y Sib. - C major chromatic scale tubes. 5 tubes: C#, E b', F#, G#, Bb".

INSTRUMENTOS MUSICALES - MUSICAL INSTRUMENTS



441 045 Tubos diatónicos bajos. 7 tubos: Do, Re, Mi, Fa, Sol, La y Si.  
Diatonic bass tubes. 7 tubes: C', D', E', F', G', A', B.



441 048 Tapón golpeo suelo. Utilizados para bajar una escala el sonido del tubo. Especiales para el golpeo vertical con el suelo.

Stoppers for going down C major diatonic musical scale one octave.





#### 441 050 CAMPANITAS MUSICALES

Conjunto de 8 campanitas musicales perfectamente afinadas. Escala diatónica. Novedoso sistema doble de percusión, mediante mango tradicional y pulsación. Incluye librito musical.

*Set of 8 perfectly tuned music bells. Diatonic scale. New double system of percussion with the traditional handle and push button. With musical book.*



**441 054** Campanitas musicales de mesa grandes. Conjunto de 8 campanitas perfectamente afinadas. Escala diatónica. Sonido mediante pulsación. Acero y ABS. Medida: 8.2 x 8 cm. Incluye librito musical. *Big Music desk bells. Set: 8 bells with different tone. Diatonic Scale. Sound by pressing. Steel and ABS. Size: 8.2x8cm With musical book.*

**441 055** Campanitas musicales de mesa pequeñas. Conjunto de 8 campanitas perfectamente afinadas. Escala diatónica. Sonido mediante pulsación. Acero y ABS. Medida: 4.9 x 6cm. Incluye librito musical. *Small Music desk bells. Set: 8 bells with different tone. Diatonic Scale. Sound by pressing. Steel and ABS. Size: 4.9 x 6 cm. With musical book.*



**441 056** Campanitas musicales de tortuga grandes. Conjunto de 8 campanitas perfectamente afinadas. Escala diatónica. Sonido mediante pulsación. Acero y ABS. Medida: 110 x 92 cm. Incluye librito musical. *Big Music turtles. Set: 8 bells with different tone. Diatonic Scale. Sound by pressing. Steel and ABS. Size: 110 x 92 cm. With musical book.*

**441 057** Campanitas musicales de tortuga pequeñas. Conjunto de 8 campanitas perfectamente afinadas. Escala diatónica. Sonido mediante pulsación. Acero y ABS. Medida: 7.2 x 6.2 cm. Incluye librito musical. *Small Music turtles. Set: 8 bells with different tone. Diatonic Scale. Sound by pressing. Steel and ABS. Size: 7.2 x 6.2 cm. With musical book.*



**441 052** Campanitas musicales de mano grandes. Conjunto de 8 campanitas perfectamente afinadas. Escala diatónica. Sonido con mango tradicional. Acero y ABS. Medida: 7.4 x 13.6 cm. Incluye librito musical.

*Big Music Hand Bells. Set: 8 bells with different tone. Diatonic Scale. Sound by traditional system. Steel and ABS. Size: 7.4 x 13.6 cm. With musical book.*

**441 053** Campanitas musicales de mano pequeñas. Conjunto de 8 campanitas perfectamente afinadas. Escala diatónica. Sonido con mango tradicional. Acero y ABS. Medida: 4.5 x 8 cm. Incluye librito musical.

*Small Music Hand Bells. Set: 8 bells with different tone. Diatonic Scale. Sound by traditional system. Steel and ABS. Size: 4.5 x 8 cm. With musical book.*



### CAMPANITAS MUSICALES EN RUEDA - MUSICAL SPIN BELL

Este instrumento único, gira sobre una rueda de plástico. 8 campanitas con 8 notas diferentes. Para educación musical de los niños a partir de 3 Años. Escala diatónica. Sonido percusión con baqueta. Incluye librito musical. - *The bells rotate on a plastic wheel. Eight bells with 8 different notes. Diatonic scale. Sound with percussion drumstick. With musical book.*

**441 058** Campanitas musicales de rueda grande. 212 x 126 x 212 mm. *Musical big spin bell 212 x 126 x 212 mm.*

**441 059** Campanitas musicales de rueda pequeña. 150 x 95 x 150 mm. *Musical small spin bell. 150 x 95 x 150 mm.*



**441 090** Cinturón de cascabeles. - *Jingle bells belt.*



**441 012** Pulsera de cascabeles. *Jingle bells bracelet.*



**441 013** Tobillera de cascabeles. *Jingle bells ankle support.*



**441 014** Cascabeles grande. - *Big jingle bells.*

**441 015** Cascabeles mediano. - *Medium jingle bells.*

**441 016** Cascabeles pequeño. - *Small jingle bells.*





**441 085** Mini cascabel de colores con mango de madera. 17 cm.  
*Mini jingle bells coloured with wood handle. 17 cm.*



**441 095** Cascabeles con mango de plástico.  
*Jingle bells with plastic handle.*



**441 100** Maracas mini de plástico. 13 cm.  
*Mini plastic maracas 13 cm.*



**441 009** Maracas de plástico con arena.  
*Plastic maraccas with sand.*



**441 019** Castañuelas de madera con mango.  
*Wood castanets with handle.*



**441 010** Castañuelas de plástico.  
*Plastic castanets.*



**441 011** Huevos sonoros. - *Musical eggs.*



**441 017** Sambino doble. *Double sambino.*  
**441 018** Sambino triple. *Triple sambino.*



**441 120** Guiro - *Wood scrapped instrument.*



**441 060** Cabasa Ø 10 cm.



**441 033** Caja china.  
*Chinese box.*



**441 068** Palo de lluvia 30,50 cm. - *Rain maker 30,50 cm.*  
**441 069** Palo de lluvia 50 cm. - *Rain maker 50 cm.*



**441 031** Guiro 2 tonos.  
*Wood scrapped instrument in 2 tones.*



**441 030** Raspa. - *Guiro.*



**441 064** Tambor de olas. Ø 25,4 cm.  
*Wave drum. Ø 25,4 cm.*



441 027 Triángulo pequeño 10cm. *Small triangle 10 cm.*  
 441 028 Triángulo mediano. 15cm. *Medium triangle 15 cm.*  
 441 029 Triángulo grande. 20cm. *Big triangle 20 cm.*



441 032 Claves madera. - *Wood sound sticks.*



441 110 Pandereta mini de plástico. *Plastic mini tambourine.*



441 026 Crótalos. Ø 60 mm. *Cymbals Ø 60 mm.*



441 066 Platos. 20 cm. - *Big brass heavy 20 cm.*



441 020 Pandereta 10 cm. - *10 cm. tambourine.*  
 441 021 Pandereta 15 cm. - *15 cm. tambourine.*  
 441 022 Pandereta 18 cm. - *18 cm. tambourine.*  
 441 023 Pandereta 21 cm. - *21 cm. tambourine.*  
 441 024 Pandereta 23 cm. - *23 cm. tambourine.*



441 025 Media pandereta de plástico. - *Half plastic tambourine.*



441 135 Pandereta 25 cm. Crótalos dobles. Membrana plástica. *Tambourine 25 cm. Double Cymbals. Plastic membrane.*  
 441 140 Pandereta 30 cm. Crótalos dobles. Membrana plástica. *Tambourine 30 cm. Double Cymbals. Plastic membrane.*



441 115 Tambor de mano infantil de colores. 20 cm. Cuerpo de madera. Baqueta de plástico y espuma. *Children Hand Drum in colors. 20 cm. Wood body. Plastic and foam stick.*





**441 235** Tambor de suelo grande. 30 cm. Con baquetas. - *Ground drum big. 30 cm. With sticks.*

**441 230** Tambor de suelo mediano. 20 cm. Con baquetas. - *Ground drum medium. 20 cm. With sticks.*

**441 225** Tambor de suelo pequeño. 15 cm. Con baquetas. - *Ground drum small. 15 cm. With sticks.*



**441 041** Tambor. Ø 170 mm.  
*Drum Ø 170 mm.*



**441 210** Tamborín.  
*Tambourine.*



**441 040** Bongos. - *Bongos.*



**441 200** Cajón. 22 x 22 x 40 cm. Incluye bolsa de transporte.  
*Box 22 x 22 x 40 cm. Transport bag included.*



**441 245** Set de percusión grande. Bolsa compuesta por: maracas de plástico, castañuelas de plástico, 1 set de pulseras con cascabeles, 2 cascabeles grandes, sambino triple, castañuelas con mango de madera, panderetas de 18 y 21 cm. Crótalos, triángulo de 15 cm. Raspa, claves de madera, caja china, tambor 170 mm. Platos 20 cm. Cinturón con cascabeles y 2 huevos sonoros.

*Big percussion set. Bag composed by: plastic maracas, plastic castnet, sleight bell bells 1 set, sleight 4 jingle bells big, triple sambino, castnet on handle natural, tambourine 18 and 21 cm. Brass heavy, triangle 15 cm. Double wood block, hardwood, wood block 17,5 cm. tambourine 17 cm. Big brass heavy 20 cm. Jingle bells belt. Chicken shake in bulk.*



**441 250** Set de percusión pequeño. Bolsa compuesta por: Claves de madera, crótalos con mango de madera, raspa, caja china, maracas de madera, castañuela de madera con mango, pandereta 15 cm. platos de 15 cm. triángulo pequeño y pulsera de cascabeles.

*Small percussion set. Bag composed by: wood sound, sticks, cymbals with wood handle, guiro, chinese box, wood maracas, wood castanets with handle, 15 cm. tambourine, 15 cm. big brass heavy, small triangle and jingle bells bracelet.*





440 904 Flauta tenor barroca. - *Baroque Tenor flute.*



440 903 Flauta alto barroca. - *Baroque Contralto flute.*



440 901 Flauta soprano moderna. - *Modern soprano flute.*



441 008 Carrillón.



441 070 Carrillón curvo de 8 notas diatónico.  
*Carrillon 8 notes diatonic.*



441 072 Carrillon 8 notas separadas diatónico. - *Chimes. 8 notes.*



441 185 Campanas tubulares sin base. - *Tubular bells without base.*

## 441073 SET DE INICIACIÓN A LA MÚSICA - SET FOR INITIATION IN MUSIC

Juego para el desarrollo del sentido del ritmo y la iniciación en el lenguaje musical.

Cada color corresponde a una nota musical. El profesor con la ayuda del libro colocará en la pizarra las fichas de colores que componen la canción. Cada niño tendrá una tecla de un color y una baqueta. Los niños seguirán los colores de la pizarra y harán sonar su tecla cuando corresponda. Para niveles más avanzados el profesor podrá escribir en los círculos magnéticos el nombre de la nota musical con los rotuladores, e incluso podrá dibujar un pentagrama en la pizarra magnética para iniciación en el lenguaje musical.

Carrillón de 13 notas en 13 colores diferentes. 13 baquetas de madera. 1 Pizarra magnética de 110 x 60 cm.

2 Rotuladores y un borrador. 224 círculos magnéticos de 8 cm diámetro en 13 colores. 1 Libro con partituras musicales. 34 canciones infantiles (24 en castellano y 10 en inglés).

*Game for developing the sense of rhythm and introducing into music theory and practice.*

*Every color is a musical note. Teacher place the color fridge magnet on the white-board following the musical book. Every child take one color-key and one drumstick. Children follow the color fridge magnet on the white-board and play their color-key when it is their turn. ADVANCED LEVEL: Teacher can write the note name on the fridge magnet with the labelling, and can draw one staff on the white-board for introducing into music theory.*

*Composition: Chimes with 13 separated notes in 13 colors. 13 drumsticks. 1 magnetic white board 110 x 60 cm. 2 labelings and 1 eraser. 244 round fridge magnet 8 cm in 13 colors. 1 musical book with scores (24 spanish songs and 10 english songs)*

**441074** Set compuesto por carrillón y libro con partituras musicales.

*Set of 13 separated chimes and music book ( 24 spanish songs and 10 english songs)*

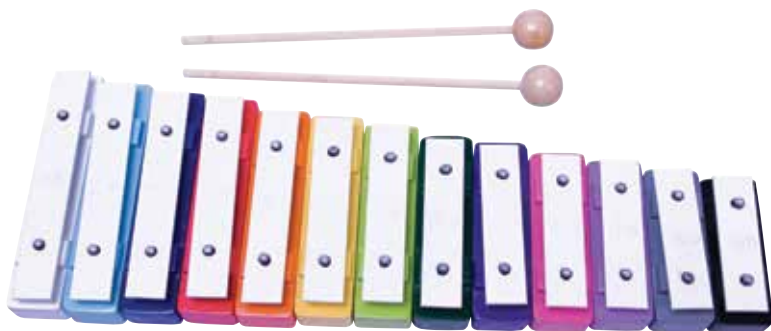

**441 075** Pizarra magnética de 110 x 60 cm. con rotuladores y borrador.  
*Magnetic white board 110 x 60 cm. with 2 labelings and 1 eraser.*



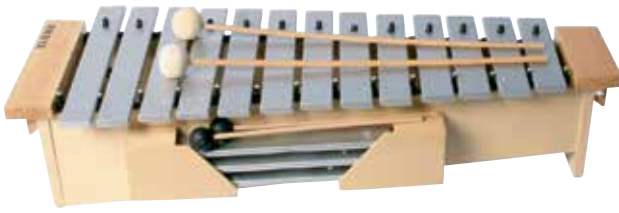

441 006

**441 006** Metalófono C3-A4. - *Metalophone C3-A4.*  
Metalófono con 3 plaquetas intercambiables para diferentes escalas.  
*Metalophone with 3 interchangeable plates for diverse sounds.*

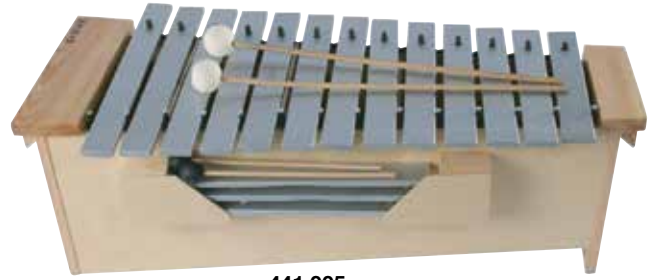

441 005

**441 005** Metalófono C2-A3. - *Metalophone C2-A3.*  
Metalófono con 3 plaquetas intercambiables para diferentes escalas.  
*Metalophone with 3 interchangeable plates for diverse sounds.*



- 441 034 Baqueta 1. Caucho. - *Drumstick 1. Rubber.*
- 441 035 Baqueta 2. Madera. - *Drumstick 2. Wood.*
- 441 036 Baqueta 3. Plástico. - *Drumstick 3. Plastic.*
- 441 037 Baqueta 4. Plástico. - *Drumstick 4. Plastic.*
- 441 038 Baqueta 5. Lana. - *Drumstick 5. Wool.*
- 441 039 Baqueta 6. Fibra. - *Drumstick 6. Fiber.*
- 441 145 Baquetas Boo Boo 7. Madera. - *Boo Boo Drumstick 7. Wood*



**441 007** Pie de apoyo de xilófonos y metalófonos.  
*Xilophone and metallophone support.*



## TAMBOR DE LENGUA

El Tambor de lengua es un instrumento de percusión de la familia de los idiófonos (instrumentos que generan sonidos mediante la vibración del propio material, sin necesidad de cuerdas, membranas o resonadores externos).

Muy melódico apreciado por sus sonidos relajantes. Resulta muy sencillo de tocar. Incluye bolso de transporte, baquetas con soporte, gomas golpeo dedos y libro de canciones.

*The Tongue drum is a percussion instrument of the idiophone family (instruments that generate sounds through the vibration of the material itself, without the need for strings, membranes or external resonators). Very melodic, appreciated for the relaxing sounds. Very easy to play. Includes carrying bag, drumsticks with stand, finger tapping erasers and song book.*



**441 236 30** Tambor De Lengua 30 cm.  
*Tongue drum 30 cm.*



**441 236 20** Tambor De Lengua 20 cm.  
*Tongue drum 20 cm.*

# 2

**MOBILIARIO INFANTIL:  
CAMITAS, ESPEJOS Y SUELOS**

***CHILDREN'S FURNITURE:  
BEDS, MIRRORS AND GROUNDS***





## TAPIZ PUZZLE EVA

Fabricado en material EVA seguro. Cumple certificado europeo referente a la inflamabilidad. Resistencia al fuego M2. Densidad: 35kg/m2. Colores: rojo, amarillo, azul y verde. Reversible.

Made with safe EVA material. Meets European certificate regarding flammability. Fire resistance M2. Density: 35kg / m2. Colors: red, yellow, blue and green. Reversible.



**410 319** Baldosa tapiz puzzle 50 x 50 x 2 cm. Fabricada en EVA densidad 35.  
Carpet puzzle. 50 x 50 x 2 cm. Made of EVA density 35.

**410 320** Lateral tapiz puzzle. Fabricada en EVA densidad 35.  
Lateral side. Made of EVA density 35.

**410 321** Esquina tapiz puzzle. Fabricada en EVA densidad 35.  
Corner puzzle. Made of EVA density 35.

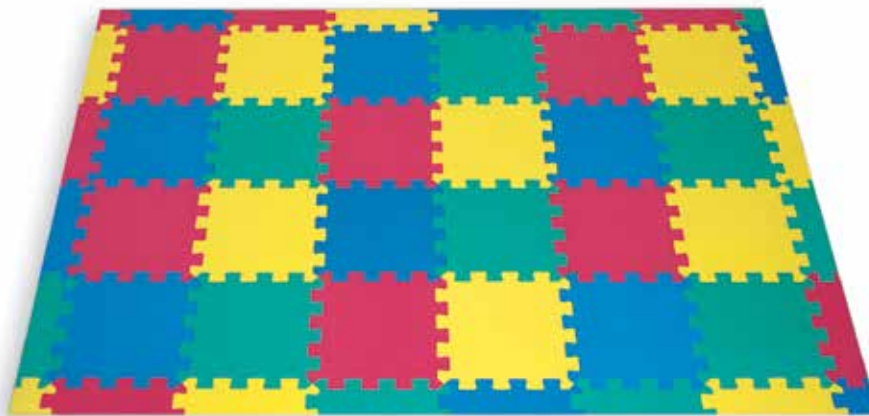

**410 322** Set 308 x 214 x 2 cm. 24 baldosas, 20 laterales, 4 esquinas. Fabricadas en EVA densidad 35.  
Set 308 x 214 x 2 cm. 24 tiles, 20 sides, 4 corners. Made of EVA density 35.



**410 323** Set 214 x 214 x 2 cm. 16 baldosas, 16 laterales, 4 esquinas. Fabricadas en EVA densidad 35.  
Set 214 x 214 x 2 cm. 16 tiles, 16 sides, 4 corners. Made of EVA density 35.



**410 324** Set 167 x 214 x 2 cm. 12 baldosas, 14 laterales, 4 esquinas. Fabricada en EVA densidad 35.  
Set 167 x 214 x 2 cm. 12 tiles, 14 sides, 4 corners. Made of EVA density 35.

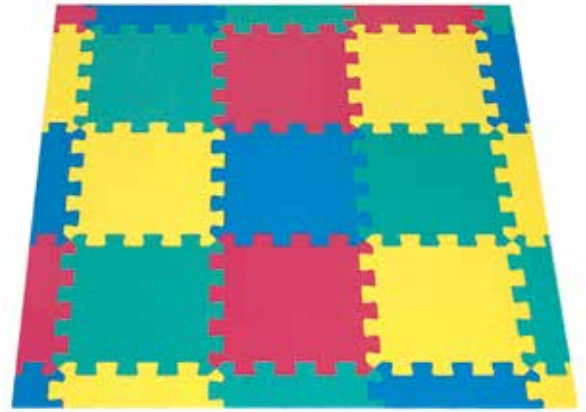

**410 325** Set 167 x 167 x 2 cm. 9 baldosas, 12 laterales, 4 esquinas. Fabricadas en EVA densidad 35.  
Set 167 x 167 x 2 cm. 9 tiles, 12 sides, 4 corners. Made of EVA density 35.



**410 326** Set 120 x 167 x 2 cm. 6 baldosas, 10 laterales, 4 esquinas. Fabricadas en EVA densidad 35.  
Set 120 x 167 x 2 cm. 6 tiles, 10 sides, 4 corners. Made of EVA density 35.



**410 327** Set 120 x 120 x 2 cm. 4 baldosas, 8 laterales, 4 esquinas. Fabricadas en EVA densidad 35.  
Set 120 x 120 x 2 cm. 4 tiles, 8 sides, 4 corners. Made of EVA density 35.

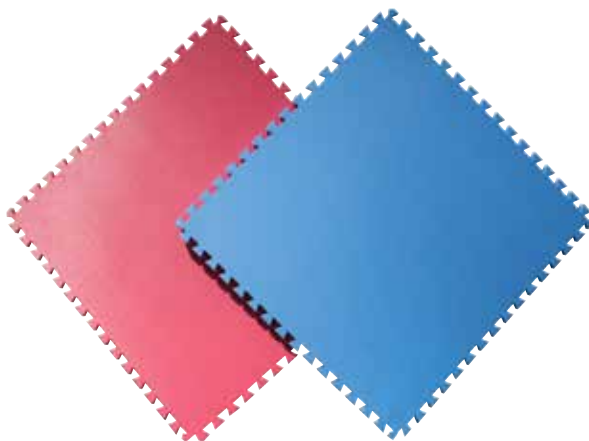

**410 328** Suelos de EVA de 100 x 100 x 2 cm. Fabricado en EVA densidad 35. Protección anti-bacterias.  
EVA carpet puzzle. of 100 x 100 x 2 cm. Made of EVA density 35. Antibacterial treatment.

**410 329** Suelos de EVA de 100 x 100 x 1 cm. Fabricado en EVA densidad 35. Protección anti-bacterias.  
EVA carpet puzzle. of 100 x 100 x 1 cm. Made of EVA density 35. Antibacterial treatment.



**410 330** Suelo de EVA densidad 35 Kg/m<sup>3</sup>. Medidas: 100 x 100 x 1 cm. Compuesto de 4 baldosas centrales, 8 laterales y 4 esquinas.  
EVA carpet puzzle density 35 kg/m<sup>3</sup>. Measure: 100 x 100 x 1 cm. Composed by 4 central tiles, 8 laterals and 4 corners.

**410 331** Baldosa de EVA densidad 35 Kg/m<sup>3</sup>. Medidas: 46 x 46 x 1 cm.  
- EVA tile density 35 kg/m<sup>3</sup>. Measure: 46 x 46 x 1 cm.

**410 332** Baldosa lateral de EVA densidad 35 Kg/m<sup>3</sup>. Medidas: 46 x 1 cm.  
- EVA side density 35 kg/m<sup>3</sup>. Measure: 46 x 1 cm.

**410 333** Baldosa esquina de EVA densidad 35 Kg/m<sup>3</sup>. 1 cm. - EVA corner density 35 kg/m<sup>3</sup>. 1 cm.



**SUELO EVA AUTUMN**

220 x 120 x 2 cm. - Puzzle EVA carpet Autumn 220 x 120 x 2 cm.



**410 344 04** Suelo Autumn.  
Amarillo, naranja, fucsia y verde.  
Autumn carpet.  
Yellow, orange, fuchsia and green.



**410 344 02** Suelo Autumn azul.  
Blue Autumn carpet.



**410 344 03** Suelo Autumn.  
Amarillo, azul, fucsia y verde.  
Autumn carpet.  
Yellow, blue, fuchsia and green.



**410 344 01** Suelo Autumn verde.  
Green Autumn carpet.

## SUELO EVA SNOW.

220 x 115,3 x 2 cm. - Puzzle EVA carpet Autumn 220 x 115,3 x 2 cm.



**410 345 02** Suelo Snow azul.  
*Blue Snow carpet.*



**410 345 04** Suelo Snow.  
Amarillo, naranja, fuxia y verde.  
*Snow carpet.*  
*Yellow, orange, fuchsia and green.*



**410 345 03** Suelo Snow.  
Amarillo, azul, fuxia y verde.  
*Snow carpet.*  
*Yellow, blue, fuchsia and green.*

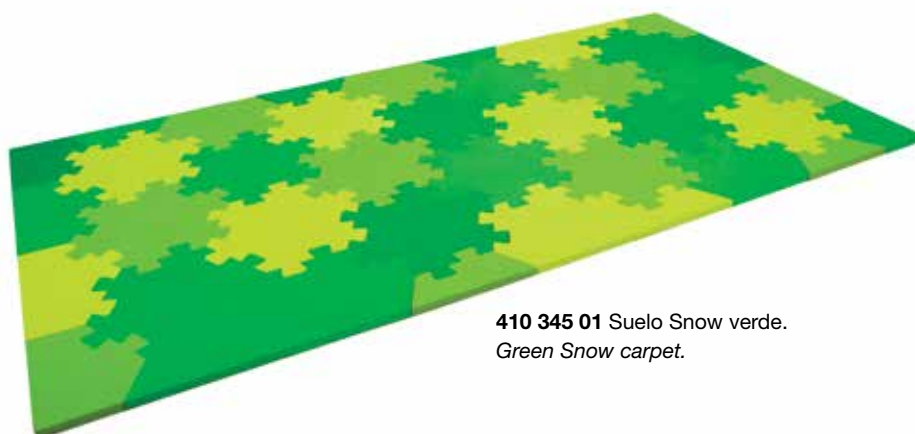

**410 345 01** Suelo Snow verde.  
*Green Snow carpet.*





## Valla de Guardería Plegable

Valla de guardería de fácil y rápido plegado. Se guarda fácilmente aprovechando al máximo el espacio. Fabricada en un material ligero y resistente. Incluye los anclajes. Medidas; 106 cm x 67 cm x 5 cm. Set de 4 unidades. Colores Verde o Azul. Preparada para usarse como piscina de bolas.(pelotas mínimo de 75mm).

*Nursery fence easy and fast folding. Easy storage. Made of a light and resistant material. Includes the anchors. Measurements; 106 cm x 67 cm x 5 cm. Set of 4 units. Colors Green or Blue. Can be used in pools (minimum 75mm)*

**438 003 11** Valla de Guardería plegable, color azul. / Nursery fence easy and fast folding. Blue.

**438 003 18** Valla de Guardería plegable, color verde. / Nursery fence easy and fast folding. Green.

**438 003 99** Valla de Guardería plegable, multicolor. / Nursery fence easy and fast folding. Multicolor.

## SUELOS DE CAUCHO

Los suelos de caucho AMAYA son la solución para las áreas de juego y todo tipo de instalaciones, que necesitan un sistema de absorción de impactos. Nuestros suelos cumplen con la normativa EN-1177:1997 de determinación de la altura de caída crítica de impacto.

Colores: Rojo, verde y gris oscuro.

*The rubber grounds AMAYA are the solution for the playground areas and other kind of places, that need an impact absorption system. Our rubber grounds carry out with the EN-1177:1997 normative of critical impact heigh fall determination.*

*Color: Red, green and dark grey*

Baldosas de caucho 50 x 50 x 2 cm. - *Rubber tile 50 x 50 x 2 cm.*

43992109 - Verde - *Green*

43992114 - Gris - *Grey*

43992107 - Rojo - *Red*



Esquina de caucho 50 x 50 cm.

*Rubber corner 50 x 50 cm.*

43991907 - Rojo - *Red*

43991909 - Verde - *Green*



Baldosas de caucho 50 x 50 x 4 cm. - *Rubber tile 50 x 50 x 4 cm.*

43992209 - Verde - *Green*

43992214 - Gris - *Grey*

43992207 - Rojo - *Red*

43992213 - Negro - *Black*



Lateral de caucho 50 x 50 cm.

*Rubber side 50 x 50 cm.*

43992009 - Verde - *Green*

43992014 - Gris - *Grey*

43992007 - Rojo - *Red*





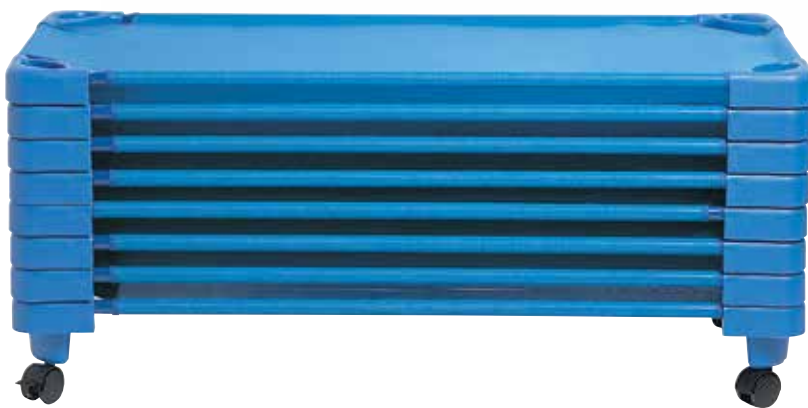

**439 915** Camas Guardería. Medidas: 132 x 58 cm. Tubo de acero pintado con pintura epoxi en azul. peso 3,4 kg.

*Kiddy cots. Measure: 132 x 58 cm.*

**439 916** Ruedas. - *wheels.*



**439 927** Sabanita ajustable para cama de guardería.  
*Suitable Sheet for kiddy cots.*

## ESPEJOS - MIRRORS

El niño desarrolla su autoestima jugando con el espejo. Observándose con diferentes gestos y posturas, divirtiéndose con sus compañeros de guardería. Espejos fabricados en material acrílico super seguro.

Children enjoy looking and learning his physical appearance. Children makes different expressions and gestures and play with his nursery school's friends.



**411 753 ESPEJO MARIPOSA**

Medidas: 610 x 450 x 3 mm.  
Butterfly mirror.  
Measure: 610 x 450 x 3 mm.



**411 752 ESPEJO SOL**

Medidas: 255 x 255 x 2 mm.  
Sun mirror.  
Measure: 255 x 255 x 2 mm.



**411 754 ESPEJO AGUA**

Medidas: 600 x 600 x 3 mm.  
**WATER MIRROR**  
Measure: 600 x 600 x 3 mm.



**411 757 ESPEJOS COLORES**

150 x 150 x 1,5 mm. Set de 6 unidades. Colores: rojo, amarillo, azul, verde, plata y morado.  
**COLOUR MIRRORS** 150 x 150 x 1,5 mm. 6 units set. Colours: red, yellow, blue, green, silver and purple.



**411 750 ESPEJO OSITO**

Medidas: 300 x 200 x 2 mm.  
Bear mirror  
Measure: 300 x 200 x 2 mm.



**411 751 ESPEJO LUNA**

Medidas: 260 x 130 x 2 mm.  
Moon mirror.  
Measure: 260 x 130 x 2 mm.



**411 749 ESPEJO JIRAFÁ**

Con metro para medir altura.  
Jirafe mirror with scale for height measure.



**581 100 SILLA SFERA - SFERA CHAIR**

Silla Sfera. Diseño moderno e innovador. Muy cómoda y práctica. Fabricada en PE de alta resistencia. Muy útil para guarderías, jardines y viviendas. Diámetro Ø 46,2 cm. Altura de asiento: 192 mm.

*Modern and innovative design. Very comfortable and useful. Made of PE high resistance. Suitable for nurseries, kindergartens and homes. Ø 46,2 cm. Seat height: 192 mm.*



**581 110 MESA SFERA - SFERA TABLE**

Mesa Sfera. Diseño moderno e innovador. Muy cómoda y práctica. Fabricada en PE de alta resistencia. Muy útil para guarderías, jardines y viviendas. Ø 724 mm. Altura: 420 mm.

*Modern and innovative design. Very comfortable and useful. Made of PE high resistance. Suitable for nurseries, kindergartens and homes. Ø 724 mm. 420 mm. height.*



MUEBLES - FURNITURE

**581 105 SILLA CUBO / CUBE CHAIR**

365 X 370 x 350 mm. Altura de asiento 185 mm.  
365 X 370 x 350 mm. Seat height 185 mm.



# HUERTO ESCOLAR SCHOOL GARDEN

Huerto escolar trasladable, ideado para los más pequeños. Diferentes alturas. Fabricado en PE de diferentes colores. Made in Spain Facilita el aprendizaje activo y cooperativo basado en la resolución planificada de problemas, así como el desarrollo de las actitudes y valores más comprometidos con la conservación, la mejora del entorno y la utilización sostenible de los recursos ambientales.

*Portable vegetable garden for school. Designed for the youngest kids. Available in several heights. Manufactured from PE in various colours. Made in Spain. Facilitates active and cooperative learning based on planned problem-solving. Enhances conservation values and attitude development and promotes environmental awareness and sustainable resource use.*

**438 100** Huerto escolar – Incluye un contenedor superior, un soporte inferior y un set de accesorios: 6 sobres con semillas ecológicas, 1 saco de tierra, 1 pala, 1 paleta, 1 rastrillo, 1 regadera, 6 tutores o guías para sujetar las plantas y un set de ruedas.  
Medidas/ Measures : 900 x 500 x 625 mm.

*438 100 Garden for school - Set includes an upper piece, a lower piece and one set with accessories: 6 bags with ecologic seeds, 1 soil sac, 1 shovel, 1 spade, 1 fork, 1 watering can, 6 sticks to hold plants and one set of wheels.*

**438 101** Huerto escolar doble altura – Incluye un contenedor superior, dos soportes inferiores y un set de accesorios: 6 sobres con semillas ecológicas, 1 saco de tierra, 1 pala, 1 paleta, 1 rastrillo, 1 regadera 6 tutores o guías para sujetar las plantas y un set de ruedas.  
Medidas/ Measures: 900 x 500 x 875 mm.

*438 101 Double height garden school - Set includes an upper piece, two lower pieces and one set with accessories: 6 bags with ecologic seeds, 1 soil sac, 1 shovel, 1 spade, 1 fork, 1 watering can, 6 sticks to hold plants and one set of wheels.*

**438 102** Contenedor superior completo, con accesorios.  
No se incluyen ruedas.

*438 102 Single upper piece – Wheels not included.  
Medidas/ Measures: 900 x 500 x 300 mm.*

**438 103** Soporte inferior, sin accesorios.  
No se incluyen ruedas.

*438 103 Single lower piece – Wheels not included.  
Medidas/ Measures: 760 x 435 x 310 mm.*



**438 102**



439 916 Ruedas de Huerto Escolar.  
Wheels for School garden.

438 104 Contenedor superior sin accesorios.  
Upper container without accessories.



438 100

62,5 cm.

50 cm.



438 101

87,5 cm.



438 108 Regadera pulverizador.  
Watering garden.



438 107 Marcadores plantas.  
12 unidades.  
Planter marker 12 pcs.



438 105 Kit jardinería 3 pcs. - Garden's kit 3 pcs.



438 109 Delantal jardinería niño.  
Kid's gardening apron.



438 10601 Guantes niño 8,5".  
Kid's gloves with 8,5"



438 10600 Guantes niño 7"  
Kid's gloves with 7"

## NUEVOS MUEBLES DE FOAM

Fabricados en Foam de Poliuretano con recubrimiento especial plástico y elástico, que confiere gran resistencia a la pieza. Agradable al tacto. No tóxico e ignífugo. Lavable con agua y jabón neutro. Uso restringido a interiores y preferible sin calzado.

Cumple normativa del juguete EN-71 del juguete la cual exige seguridad referente a: Propiedades mecánicas y físicas, Inflamabilidad y migración de ciertos elementos

Colores: Blanco, rosa fluor, verde fluor, amarillo fluor, naranja fluor, rojo y azul. Posibilidad también de color verde oscuro, negro, azul claro y otros colores mezclando los anteriores.

### NEW FOAM FURNITURE

Made of Polyurethane Foam, covered with special plastic and elastic, that provide higher resistance. Nice touch. Non toxic and fireproof. Washable with water and neutral soap. Only for inner spaces and preferably barefoot. Meets the requirements of EN-71 Toys regulation, that demands safety for: mechanical and physical properties, flammability, and migration of certain elements. Available colours: White, fluor pink, fluor Green, fluor yellow, fluor orange, red and blue. Chance for manufacture in dark Green, black, light blue, and other tones mixing the previous ones.

## SILLA PUPITRE

SILLA PUPITRE 80 x 40 x 100 cm. Altura de sentado: 23 cm.

Desk chair 80 x 40 x 100 cm. Seat height 23 cm.



580 007 27

Fucsia



580 007 11  
Azul / Blue



580 007 00  
Blanco / White



580 007 07  
Rojo / Red



580 007 25  
Amarillo / Yellow



580 007 26  
Naranja / Orange



580 007 28  
Verde / Green



## PUFF

580 033 27 Puff 35 x 35 x 22 cm. Superficie de sentado 25 x 25 cm. Fucsia.  
 Puff 35 x 35 x 22 cm. Seat area 25 x 25 cm. Fuchsia



580 033 11  
Azul / Blue



580 033 28  
Verde / Green



580 033 26  
Naranja / Orange



580 033 25  
Amarillo / Yellow



580 033 01  
Blanco / White



580 033 07  
Rojo / Red

## SILLA CURVA

Silla curva pequeña 39 x 38 x 62 cm. Altura de sentado 22 cm.  
 Small curve chair 39 x 38 x 62 cm. Sitting height 22 cm.



580 004 25  
Amarillo / Yellow



580 004 26  
Naranja / Orange



580 004 11  
Azul / Blue



580 004 01  
Blanco / White



580 004 07  
Rojo / Red



580 004 28  
Verde / Green



580 004 27  
Fucsia.

## SILLA DOBLE

92 x 38.5 x 64 cm. Altura de sentado 22 cm. y 26 cm.

Double chair 92 x 38.5 x 64 cm. Seat height 22 cm. and 26 cm.



580 006 27  
Fucsia / Fuchsia



580 006 25  
Amarillo / Yellow



580 006 26  
Naranja / Orange



580 006 28  
Verde / Green



580 006 11  
Azul / Blue



580 006 01  
Blanco / White



580 006 07  
Rojo / Red



## MESA HEXAGONAL

Mesa hexagonal con pie 100 x 100 x 45 cm.  
Hexagonal table 100 x 100 x 45 cm.



580 032 25  
Amarillo / Yellow



580 032 26  
Naranja / Orange



580 032 28  
Verde / Green



580 032 11  
Azul / Blue



580 032 01  
Blanco / White



580 032 07  
Rojo / Red



580 032 27  
Fucsia/ Fuchsia

## MESA HEXAGONAL

Mesa hexagonal 50 x 50 x 35 cm .  
Hexagonal table 50 x 50 x 35 cm.



580 031 25  
Amarillo / Yellow



580 031 26  
Naranja / Orange



580 031 27  
Fucsia/ Fuchsia



580 031 11  
Azul / Blue



580 031 01  
Blanco / White



580 031 07  
Fucsia/ Fuchsia

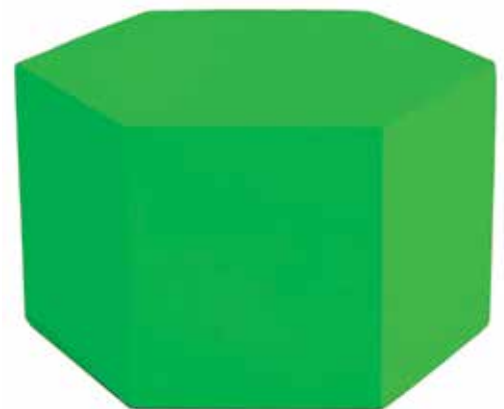

580 031 28 Verde / Green

**SOFÁ**

Sofá 100 x 42 x 60 cm. Altura sentado 26 cm.  
Sofá 100 x 42 x 60 cm. Sitting height 26 cm.



**580 011 25**  
Amarillo / Yellow



**580 011 11**  
Azul / blue



**580 011 26**  
Naranja / Orange



**580 011 27**  
Fucsia / Fuchsia



**580 011 28**  
Verde / Green



**580 011 00**  
Blanco / White



**580 011 07**  
Rojo / Red

**MESA REDONDA**

Mesa redonda 60 x 60 x 30 cm.



**580 030 25**  
Amarillo / Yellow



**580 030 27**  
Fucsia / Fuchsia



**580 030 26**  
Naranja / Orange



**580 030 11**  
Azul / blue



**580 030 00**  
Blanco / White



**580 030 07**  
Rojo / Red



**580 030 28**  
Verde / Green



CONJUNTO 4 PIEZAS

Set 4 pieces



580 000 99 Muebles de guardería foam recubierto. Set de 4 piezas. Multicolor.  
*Piece of kiddy furniture. Coated foam. Set 4 pieces. Multicolor.*



580 000 25  
 Amarillo / Yellow



580 000 27  
 Fucsia/ Fuchsia



580 000 28  
 Verde/ Green



580 000 11  
 Azul/ Blue



580 000 07  
 Rojo / Red



580 000 26  
 Naranja / Orange



580 000 01  
 Blanco / White

MUEBLES - FURNITURE

## CONJUNTO 2 SILLAS Y MESA REDONDA

2 chairs and round table Kit.



580 003 99  
Multicolor



580 003 11  
Azul / Blue



580 003 27  
Fucsia/ Fuchsia



580 003 26  
Naranja / Orange



580 003 28  
Verde / Green



580 003 25  
Amarillo / Yellow



580 003 07  
Rojo / Red



580 003 01  
Blanco / White



**CONJUNTO 6 SOFAS Y MESA HEXAGONAL**

6 Sofas and hexagonal table Set.

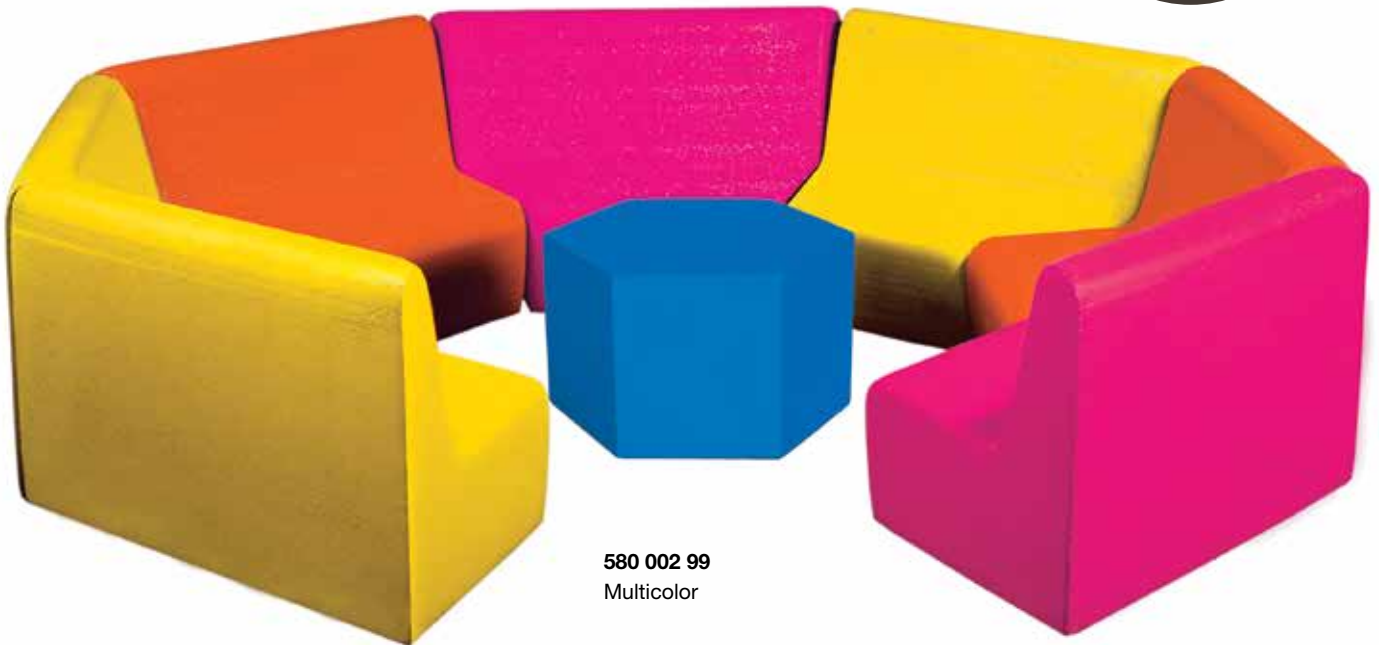

**580 002 99**  
Multicolor



**580 002 07**  
Rojo / Red



**580 002 11**  
Azul / Blue



**580 002 28**  
Verde / Green



**580 002 27**  
Fucsia/ Fuchsia



**580 002 25**  
Amarillo / Yellow



**580 002 26**  
Naranja / Orange



**580 002 01**  
Blanco / White

MUEBLES - FURNITURE

SET COJINES

Medidas cojines 30 x 30 x 8 cm.  
Cuadrado, redondo, triangular y hexagonal.

Cushion meassures 30 x 30 x 8 cm.  
Square, round, triangle and hexagon.



580 034 99  
Multicolor

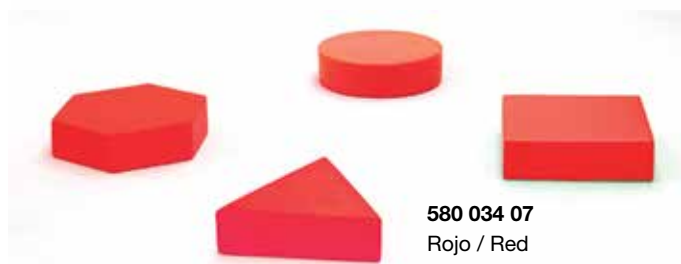

580 034 07  
Rojo / Red



580 034 26  
Naranja./ orange

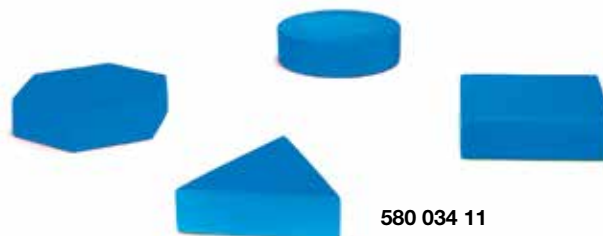

580 034 11  
Azul / Blue

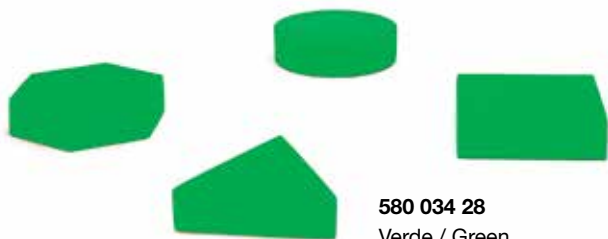

580 034 28  
Verde / Green



580 034 25  
Amarillo / Yellow

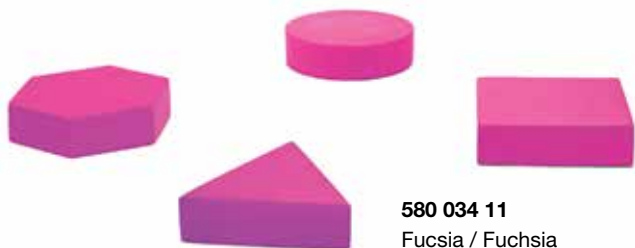

580 034 11  
Fucsia / Fuchsia



580 034 01  
Blanco / White

MUEBLES - FURNITURE



## COJÍN HEXAGONAL

Medidas cojines / Cushion measure: 30 x 30 x 8 cm.



**580 038 27** Cojín hexágono fucsia.  
*Fuchsia hexagon cushion.*



**580 038 26**  
Naranja / Orange



**580 038 11**  
Azul / Blue



**580 038 28**  
Verde / Green



**580 038 25**  
Amarillo / Yellow



**580 038 28**  
Rojo / Red



**580 038 01**  
Blanco / White

## COJÍN CIRCULAR

Medidas cojines: 30 x 30 x 8 cm.



**580 037 11** Cojín círculo azul.  
*Blue round cushion.*



**580 037 27**  
Fucsia / Fuchsia



**580 037 26**  
Naranja / Orange



**580 037 28**  
Verde / Green



**580 037 25**  
Amarillo / Yellow



**580 037 28**  
Rojo / Red



**580 037 01**  
Blanco / White

## COJÍN TRIANGULAR

Medidas cojines: 30 x 30 x 8 cm.



**580 036 28** Cojín triángulo verde.  
*Green triangular cushion.*



**580 036 11**  
Azul / Blue



**580 036 27**  
Fucsia / Fuchsia



**580 036 26**  
Naranja / Orange



**580 036 25**  
Amarillo / Yellow



**580 036 28**  
Rojo / Red



**580 036 01**  
Blanco / White

## COJÍN CUADRADO

Medidas cojines: 30 x 30 x 8 cm.



**580 035 26** Cojín cuadrado naranja.  
*Orange square cushion.*



**580 035 11**  
Azul / Blue



**580 035 27**  
Fucsia / Fuchsia



**580 035 28**  
Verde / Green



**580 035 25**  
Amarillo / Yellow



**580 035 28**  
Rojo / Red



**580 035 01**  
Blanco / White

## SERPIENTE

Serpiente 210 x 30 x 25 cm. Unión de dos bancos rueda mediante velcros.  
Snake 210 x 30 x 25 cm. Union of two wheel benches by means of velcro.



580 040 26  
Naranja / Orange



580 040 27  
Fucsia / Fuchsia

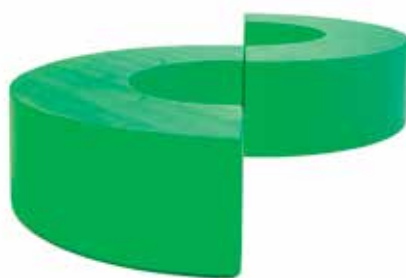

580 040 28  
Verde / Green



580 040 25  
Amarillo / Yellow

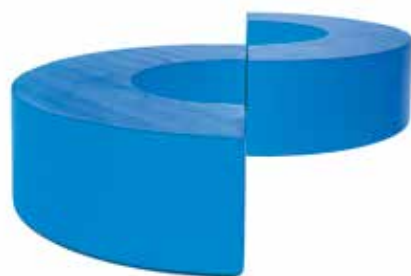

580 040 11  
Azul / Blue



580 040 01  
Blanco / White



580 040 07  
Rojo / Red



## BANCO RUEDA

Banco rueda / Round bench 118 x 30 x 25 cm.



580 039 11  
Azul / Blue



580 039 28  
Verde / Green



580 039 27  
Fucsia / Fuchsia



580 039 25  
Amarillo / Yellow



580 03901  
Blanco / White



580 039 07  
Rojo / Red



580 039 26  
Naranja / Orange

## BANCO RECTO

Banco recto 175 x 30 x 25 cm.



580 041 25  
Amarillo / Yellow



580 041 27  
Fucsia.



580 041 07  
Rojo / Red.

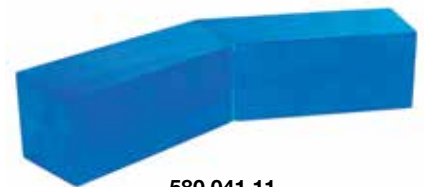

580 041 11  
Azul / Blue



580 041 26  
Naranja / Orange



580 041 28  
Verde / Green



580 041 01  
Blanco / White



**SILLAS**

Estructura fabricada en madera de haya maciza de primera calidad, barnizada al agua no tóxica. Asiento y respaldo ergonómicos, diferentes para cada edad, fabricados en estratificado de 9mm. de gran resistencia. Cantos redondeados para mayor seguridad. Patas traseras arqueadas para evitar el vuelco. Máxima calidad de acabados.

Diferentes colores, Madera Natural, Azul, Rojo, Verde y Amarillo. Apilables. Acorde a la normativa UNE-EN 1729-1: 2007.

**CHAIRS**

Made with high quality and varnished solid beechwood. Seat with ergonomic back made in 9mm thick very resistant stratified wood. Safety rounded edges. Curved rear legs for avoiding fall down. High quality finishing. Different colors, Natural wood, blue, red, green and yellow. Possible to pill up. Comply UNE-EN 1729-1: 2007.

**581 003** Silla 3. Altura: 34 cm.  
Chair 3. Height: 34 cm.



**581 002** Silla 2. Altura: 30 cm.  
Chair 2. Height: 30 cm.

**581 001** Silla 1. Altura: 26 cm.  
Chair 1. Height: 26 cm.

**TABLA DE COLORES DE SILLAS Y MESAS.**







581 504 Mesa modelo 2. Talla 0: 120 x 60 x 40 cm. - Table model 2. Size 0.



581 508 Mesa modelo 3. Talla 0: Ø 120 mm x 40 cm. - Table model 3. Size 0.

581 509 Mesa modelo 3. Talla 1: Ø 120 mm x 46 cm. - Table model 3. Size 1.

581 510 Mesa modelo 3. Talla 2: Ø 120 mm x 52 cm. - Table model 3. Size 2.

581 511 Mesa modelo 3. Talla 3: Ø 120 mm x 59 cm. - Table model 3. Size 3.



581 512 Mesa modelo 4. Talla 0: trapecio 120 x 60 x 40 cm. - Table model 4. Size 0.

581 513 Mesa modelo 4. Talla 1: trapecio 120 x 60 x 46 cm. - Table model 4. Size 1.

581 514 Mesa modelo 4. Talla 2: trapecio 120 x 60 x 52 cm. - Table model 4. Size 2.

581 515 Mesa modelo 4. Talla 3: trapecio 120 x 60 x 59 cm. - Table model 4. Size 3.



**581 530** Mesa redonda. Diámetro 120 cm. Talla 0. - *Round table. Diameter 120 cm. Size 0.*

**581 531** Mesa redonda. Diámetro 120 cm. Talla 1. - *Round table. Diameter 120 cm. Size 1.*

**581 532** Mesa redonda. Diámetro 120 cm. Talla 2. - *Round table. Diameter 120 cm. Size 2.*

**581 533** Mesa redonda. Diámetro 120 cm. Talla 3. - *Round table. Diameter 120 cm. Size 3.*



**581 520** Mesa herradura 180 x 90 cm. Talla 0. - *Horseshoe table 180 x 90 cm. Size 0.*

**581 521** Mesa herradura 180 x 90 cm. Talla 1. - *Horseshoe table 180 x 90 cm. Size 1.*

**581 522** Mesa herradura 180 x 90 cm. Talla 2. - *Horseshoe table 180 x 90 cm. Size 2.*

**581 523** Mesa herradura 180 x 90 cm. Talla 3. - *Horseshoe table 180 x 90 cm. Size 3.*





Muebles fabricados en madera laminada con melamina en 19 mm. y bordes de pvc. Puertas en varios colores (rojo, azul, verde amarillo y haya). Módulo pequeño. Medidas: 80 x 40 x 75 cm.  
 Furniture made of plywood with melamine 19 mm. and PVC edges. Doors in several colors (red, blue, green, yellow and beech).  
 Module small. Size: 80 x 40 x 75 cm.



582 015



582 020



582 025



582 030



582 035



582 040



582 045



582 050

**582 015** Módulo pequeño estructura. 80 x 40 x 75 cm. *Small module structure 80 x 40 x 75 cm.*

**582 020** Módulo pequeño + 1 balda vertical. *Small module + 1 vertical shelf.*

**582 025** Módulo pequeño + 1 balda horizontal 1/1. *Module + 1 small horizontal shelf 1/1.*

**582 030** Módulo pequeño + 1 balda vertical + 4 baldas horizontales 1/2. *Small module + 1 vertical shelf + 4 horizontal 1/2.*

**582 035** Módulo pequeño + 2 baldas horizontales 1/1. *Small module + 2 horizontal shelves 1 / 1.*

**582 040** Módulo pequeño + 2 verticales + 6 baldas horizontales 1/3. *Small module + 2 vertical and 6 horizontal shelves 1/3.*

**582 045** Módulo pequeño + 5 baldas horizontales 1/1. *Small module + 5 horizontal shelves 1/1.*

**582 050** Módulo pequeño + 2 verticales + 15 baldas horizontales 1/3. *Small module + 2 vertical and 15 horizontal shelves 1/3.*



**581 900** Mueble bajo. 100 x 40 x 50 cm.  
*Small furniture 100 x 40 x 50 cm.*

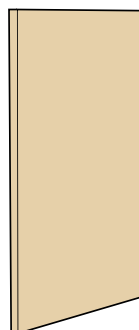

582 310

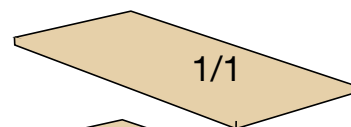

582 320

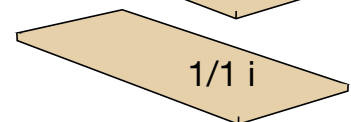

582 335



582 325

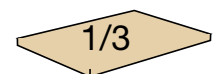

582 330

**582 310** Balda vertical pequeña. Medidas: 66,5 x 37,5 x 1,8 cm. *Small vertical shelf. Dimensions: 66.5 x 37.5 x 1.8 cm.*

**582 320** Balda horizontal 1/1. Medidas: 76 x 37,5 x 1,8 cm. *Horizontal shelf 1/1. Dimensions: 76 x 37.5 x 1.8 cm.*

**582 325** Balda horizontal 1/2. Medidas: 37,2 x 37,5 x 1,8 cm. *Horizontal shelf 1/2. Dimensions: 37.2 x 37.5 x 1.8 cm.*

**582 330** Balda horizontal 1/3. Medidas: 24,1 x 37,5 x 1,8 cm. *Horizontal shelf 1/3. Dimensions: 24.1 x 37.5 x 1.8 cm.*

**582 335** Balda horizontal 1/1 interior puertas. Medidas: 76,5 x 35,5 x 1,8 cm. *Horizontal shelf 1/1. for cupboard with doors. Dimensions: 76.5 x 35.5 x 1.8 cm.*



582 205



582 215



582 220



582 225

Módulo grande. Medidas: 80 x 40 x 177 cm. *Big module 80 x 40 x 177 cm.*

**582 205** Módulo grande 2 puertas. *Big module 2 doors.*

**582 215** Módulo grande + 1 balda horizontal 1/1. *Big module + 1 horizontal shelf 1/1.*

**582 220** Módulo grande + 2 baldas horizontales 1/1. *Big module + 2 horizontal shelves 1/1.*

**582 225** Módulo grande + 3 baldas horizontales 1/1. *Big module + 3 horizontal shelves 1/1.*

**582 250** Módulo combinación 1. *Modular combination 1.*

**582 255** Módulo combinación 2. *Modular combination 2.*

**582 260** Módulo combinación 3. *Modular combination 3.*

**582 265** Módulo combinación 4. *Modular combination 4.*

**582 270** Módulo combinación 5. *Modular combination 5.*

**582 275** Módulo combinación 6. *Modular combination 6.*



582 250



582 255



582 260



582 265



582 270



582 275

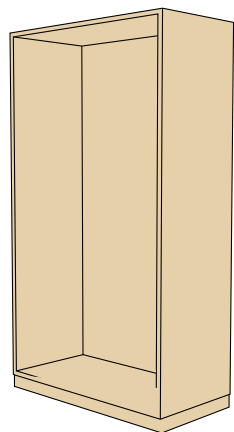

582 210

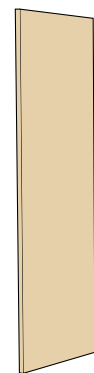

582 317

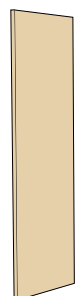

582 315



582 320



582 335

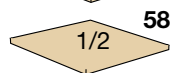

582 325



582 330

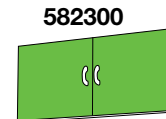

582300

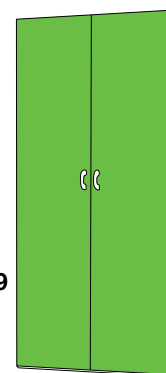

582 309

**582 210** Módulo grande estructura. *Big module structure.*

**582 300** Puertas pequeñas. 2 unidades. Medidas: 32,5 x 38 x 1,8 cm. *Small doors. 2 units. 32,5 x 38 x 1,8 cm.*

**582 309** Puertas grandes. 2 unidades. Medidas: 168 x 38 x 1,8 cm. *Big doors. 2 units. 168 x 38 x 1,8 cm.*

**582 315** Balda vertical mediana. Medidas: 134,8 x 37,5 x 1,8 cm. *Medium vertical shelf. 134,8 x 37,5 x 1,8 cm.*

**582 317** Balda vertical grande. Medidas: 169,5 x 37,5 x 1,8 cm. *Big vertical shelf. 169,5 x 37,5 x 1,8 cm.*



**JUEGOS TRADICIONALES Y  
DEPORTES ALTERNATIVOS**

***TRADITIONAL GAMES AND  
ALTERNATIVE SPORTS***

**3**







43931600

**43930300 FOOTBASKET**

Conjunto Canasta FootCesto ajustable y trasladable School system (1 poste largo + 1 base + Aro Footcesto)  
 FOOTBASKET SET

Set footbasket , adjustable and portable. School system. Includes 1 base + 1 pole + 1 hoop.

**43931600 ARO CANASTA FOOTCESTO**

Aro suelto.

FOOTBASKET HOOP

Only includes the hoop piece.



43931800

**43930500 JUEGO ARO CANASTA DOBLE / DOUBLE FOOTBASKET SET**

Conjunto Canasta Doble ajustable y trasladable School system (1 poste largo + 1 base + Aro canasta doble).  
 Set footbasket , adjustable and portable. School system. Includes 1 base + 1 pole + 1 Double hoop.

**43931800 AROS CANASTA DOBLE / DOUBLE FOOTBASKET HOOP**

Aros sueltos. / Only includes the double hoop piece.



**43930600 JUEGO POULL BALL**

Conjunto PoulBall ajustable y trasladable School system ( 2 postes cortos + 2 bases+ 2 plataformas PoulBall + 2 cubos inflables). Altura ajustable de 150 -250 cm.

**43931300 PLATAFORMA POULL BALL**

Plattform Poul Ball

**43931400 CUBO POULL BALL**

Cubo Poulball inflable con cubierta protectora.



**43931500 RED BADMINTON**



**43931200 POSTE LARGO AJUSTABLE**

Poste largo ajustable de 150 -250 cm.

**43931100 POSTE CORTO AJUSTABLE**

Poste corto ajustable de 80 -155 cm.

**43931000 BASE RELLENABLE**

Base rellenable trasladable.

**43930200 JUEGO VOLLEY-BADMINTON**

Conjunto Volley-Badminton ajustable y trasladable School system (2 postes largos + 2 bases + red).

**43930100 JUEGO BADMINTON-TENIS**

Conjunto Badminton-Tenis ajustable y trasladable School System ( 2 postes cortos +2 bases + red)



**43930400 CANASTA NETBALL**  
Set de base rellenable, poste largo y aro canasta netball

**43931700 ARO CANASTA NETBALL**  
Base rellenable trasladable.

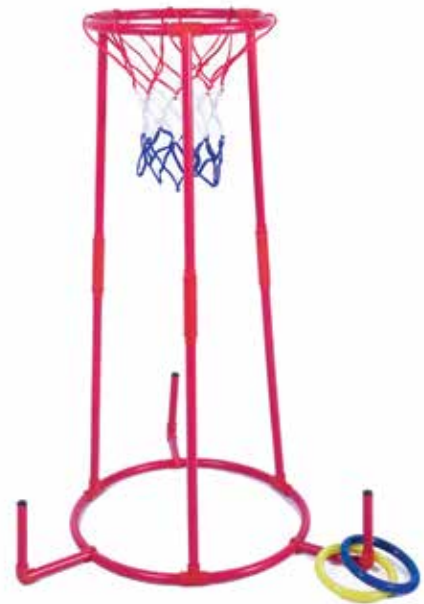

**610 125 CESTA MULTIBASKET**  
Cesta multibasket, 1 m. de alto.  
*Multibasket, Height 1 m.*



**640 201 JUEGO LANZAMIENTO DE AROS**  
Juego lanzamiento aros. Set de 3 bases, 3 picas de L=35 cm. y 15 aros diámetro 20 cm.  
*Hoop throwing set. Set of 3 bases, 3 stick L = 35 cm. and 15 hoops diameter 20 cm.*



**609 265 SOKATIRA**  
Sokatira. Longitud: 10 m. Ø 26 mm. Fabricada en algodón.  
*Tug of war. Length: 10 m. Ø 26 mm. Made of cotton.*





610 647 Juego del cucurucho. - Cone game.



610 645 Juego de la cesta. Set de 2 cestas y una pelota.- SCOOPBALL. Set 2 basket and a ball.



610 640 Juego supercatch. Set de 2 palas y una pelota.  
Supercatch. Set of 2 pales and a ball.



610 680 Manoplas con velcro. Set de 2 manoplas y una pelota.  
Mitten with velcro. Set de 2 mittens and a ball.

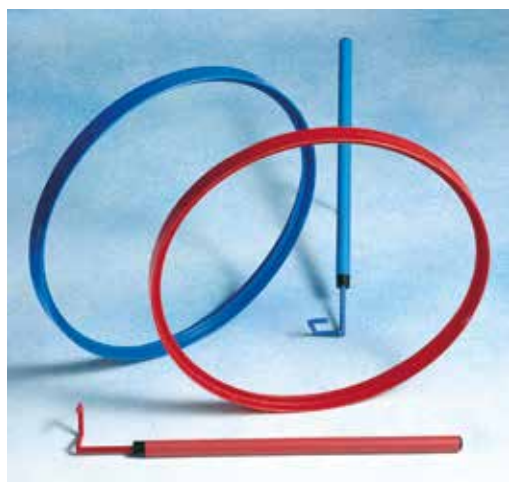

620 400 Aro guía, Ø 50 cm. - Guiding hoop Ø 50 cm.





**640 320 00 ARCO DE TIRO AMAYA SCHOOL**

Fabricado en resina Epox y fibra de carbono. Cuerda de 106 cm. Con protector de dedos.  
 Resistencia: 10 Kg. Tamaño: 135,30 cm. Peso: 835 gr.  
*AMAYA SCHOOL BOW. Made of Epoxy resin and carbon fiber. Length of rope 106 cm . With finger protector. Resistance: 10kg. Height 135.30 cm. Weight 835 gr.*

**640 320 01 CUERDA REPUESTO ARCO DE TIRO AMAYA SCHOOL**

*Amaya Bow replacement string.*



**640 320 02 ARCO DE TIRO AMAYA KIDS**

Tamaño: 121x 27 cm. Resistencia: 9 Kg.  
*Amaya Kids Bow Size 121 x 27 cm. Resistance: 9 kg.*

**640 320 03 CUERDA REPUESTO ARCO DE TIRO AMAYA KIDS**

*Amaya Kids Bow replacement string*



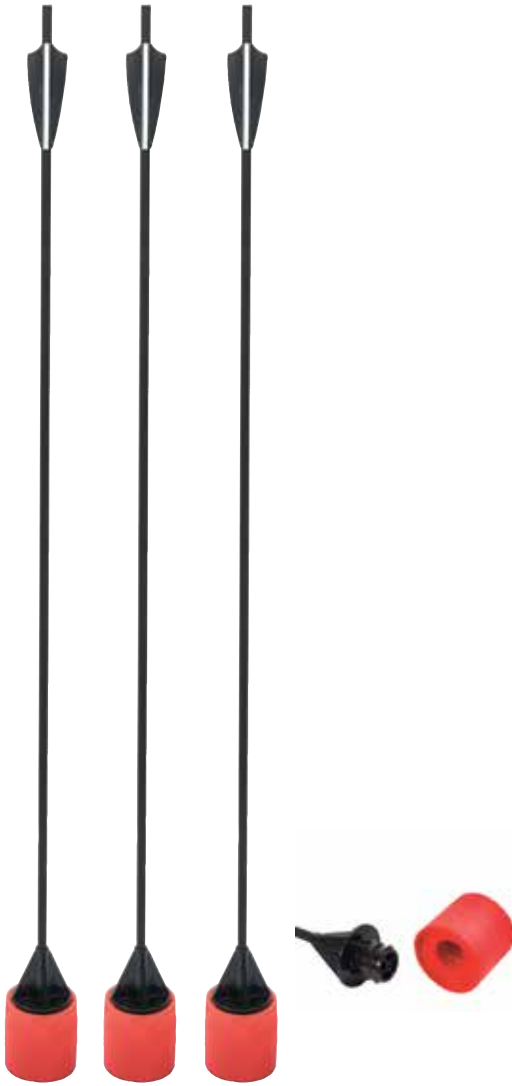

**64032004 FLECHA PARA ARCO AMAYA SCHOOL**

*Arrow for AMAYA SCHOOL bow*

**64032005 PUNTA DE FOAM PARA FLECHA AMAYA SCHOOL**

*Foam head for AMAYA SCHOOL bow*

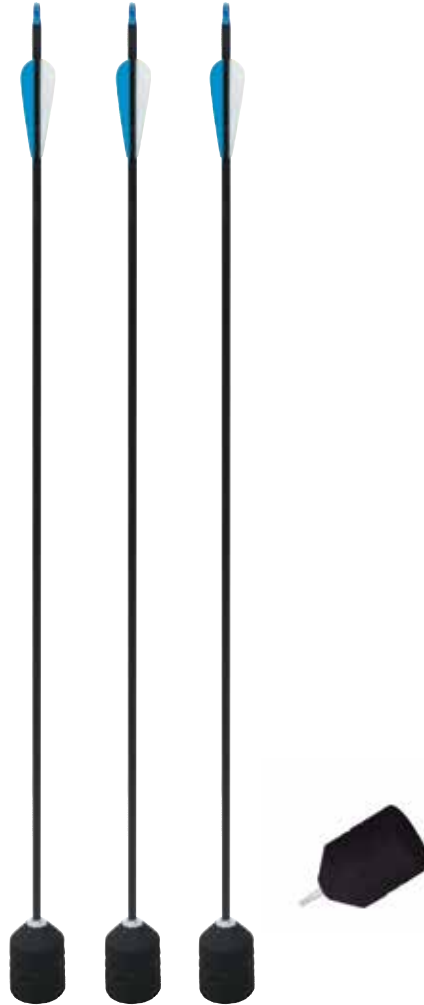

**64032006 FLECHA PARA ARCO AMAYA KIDS**

*Arrow for AMAYA KIDS bow*

**64032007 PUNTA DE FOAM PARA FLECHA AMAYA KIDS.**

*Foam head for AMAYA KIDS bow*



**64032008 FLECHA CON VENTOSA**

*Sucker Arrow*



**64032009 DIANA DE EVA**

*Tamaño: 50 x 50 x 5 cm.*

*Archery target board. Size 50 x 50 x 5 cm.*



**64032011 DIANA CON COLGADOR PARA FLECHAS CON VENTOSA**

*Target with hanger for arrows with sucker.*



**64032010 DIANA CON SOPORTE PARA FLECHAS CON VENTOSA**

*Target with holder for arrows with sucker.*



442 808 Cuerda individual de 2,5 m., con mangos de foam.  
Single rope with foam handles. 2,5 m.

442 809 Cuerda colectiva de 5 m., con mangos de foam.  
Collective rope with foam handles. 5 m.



610 705 Pelota con mango. - Ball with stick.



610 710 Pelota con asa. - Ball with handle.





**610 615** Carro scooter pequeño. 305 x 305 mm.  
Small scooter chart. 305 x 305 mm.



**610 620** Carro scooter 406 x 406 mm.  
Scooter chart 406 x 406 mm.



**610 147** Set mini-hockey. Set de 12 palas, una pelota y tres pastillas.  
Set mini-hockey. Set 12 sticks, a ball and 3 pucks.

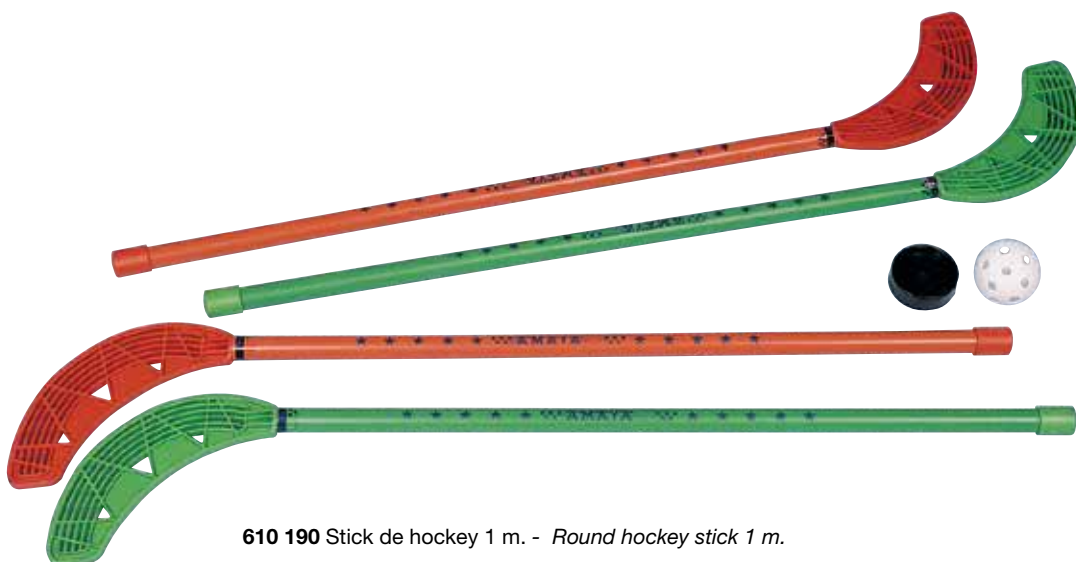

**610 190** Stick de hockey 1 m. - Round hockey stick 1 m.



**610 200** Stick de hockey 1 m. - *Hockey stick 1 m.*

**610 300** Stick de hockey 85 cm. - *Hockey stick 85 cm.*

**610 400** Pelota hockey dura, Ø 70 mm., con agujeros. - *Hockey hard ball Ø 70 mm. With holes.*

**610 500** Pelota hockey blanda, Ø 70 mm. - *Hockey soft ball Ø 70 mm.*

**610 600** Pastilla hockey. - *Hockey puck.*

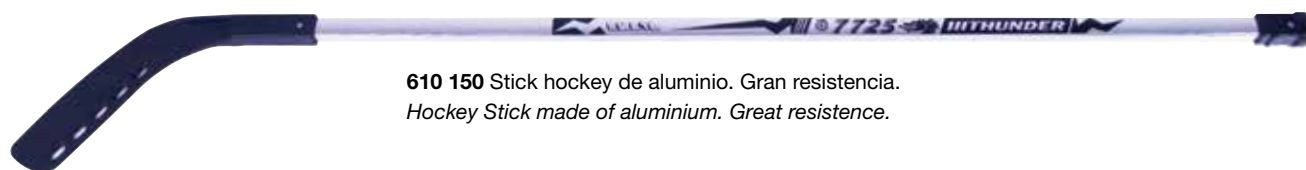

**610 150** Stick hockey de aluminio. Gran resistencia.  
*Hockey Stick made of aluminium. Great resistance.*



**610 100** Portería de hockey. Medidas: 100 x 65 x 45 cm.  
*Hockey goal. Measure: 100 x 65 x 45 cm.*





**610 145** Set de hockey foam. Compuesto por 12 sticks de foam y una pelota. Longitud: 90 cm.  
*Hockey foam SET. 12 sticks and a ball. Length: 90 cm.*



**610 112** Cesta Lacrosse con mango de aluminio. Longitud: 103 cm. - *Lacrosse basket with aluminium stick. Length: 103 cm.*  
**610 113** Pelota Lacrosse. - *Lacrosse ball.*



**610 160** Set de polo foam. Compuesto por 12 mazas de foam y una pelota Ø 160 mm. Longitud: 80 cm.  
*Polo foam SET. 12 foam hammers and a ball Ø 160 mm. Length: 80 cm.*



**610 610** Portería de tchoukball. En acero, plegable y regulable de altura. 100 x 100 cm.  
Tchoukball goal. Made of steel. Foldable, height adjustable. 100 x 100 cm.



**610 630** Portería de lanzamiento de discos. Con base rellenable de agua.  
Freesbees goal. Base filled with water.



**610 148** Portería de hockey de acero plegable. Medidas: 90 x 55 x 68 cm.  
Foldable Steel hockey goal. Measure: 90 x 55 x 68 cm.



**610 655** Canasta de juegos. Ø 50 cm.  
Games basket Ø 50 cm.





**610 155 SET SACOS DE CARRERAS**

Set sacos de carreras

Conjunto de 6 sacos de carreras de diferentes colores. Numerados del 1 al 6. Con asas para su fácil manejo. Fabricadas en nylon muy resistente con doble cosido. Divertido juego de socialización, ideal para el desarrollo de la coordinación de movimientos y el equilibrio. Medidas: 46 x 30 x 60 cm. Peso máximo del usuario: 40 Kg. Edad máxima: 11 años.

Set of 6 jump sacks of different colors. Numbered from 1 to 6. Measures 46 x 30 x 60 cm. With handles for easy handling. Made of highly resistant nylon with double stitching. Socialization fun game, ideal for the development of movement coordination and balance. Maximum weight: 40 kg. Maximum age: 11 years.



**610 625** Cama elástica funhop. 100 cm. de diámetro. Edad recomendada: de 3 a 16 años. Peso máximo de usuario: 35 kg. - Elastic funhop. Ø 100 cm. Recommended age: 3 to 16 years. Maximum weight: 35 kg.





Camas elásticas de gran seguridad. Fabricadas en tubo de acero de 38 mm. Manta elástica de PP. Cubiertas de PVC de 12 mm. de grosor. Protectores de Foam. Red de protección de PE con resistencia UV. Peso máximo: 150 Kg. Recomendado para niños mayores de 6 años.

**610 627** Cama elástica 1,9 m. - Trampolín 1,9 m.

**610 628** Cama elástica 3,7 m. - Trampolín 3,7 m.

**610 629** Cama elástica 4,3 m. - Trampolín 4,3 m.

*Galvanized Steel Pipes inside/outside, 38mmx1.5mm Bounce Mat: PP material. Spring Cover: PVC fabric with 12mm thickness EVA foam padding, UV resistant "U" shape legs: 4pcs, galvanized inside&outside,38mmx1.5mm Enclosure: PE material for the safety net, UV resistant, 25X1.2mm 8X2pcs of pole tubes with EPE sleeve, Entrance with hooks and zipper Standard approval EN71. Maximum load: 150 Kg. Age recommendation 6 and up.*



**610 626** Cama elástica 1,4 m.

Trampolín 1.4m. Muy seguro

Fabricado en Acero resistente a la corrosión recubierto de protectores de vinilo.

Contiene red de protección.

La red contiene protector para rayos UV y cremallera para entrar en el interior.

Diámetro: 140cm. Altura: 35cm. Embalaje: 74 x 24 x 27 cm.

Peso máximo del usuario: 36 Kg.

Trampolín 1,4 m. *Very safe.*

*Made of steel with vinyl protector.*

*Diameter: 140 cm. Height: 35 cm.*

*Packaging: 74 x 24 x 27 cm.*

*Max load: 36 kg.*



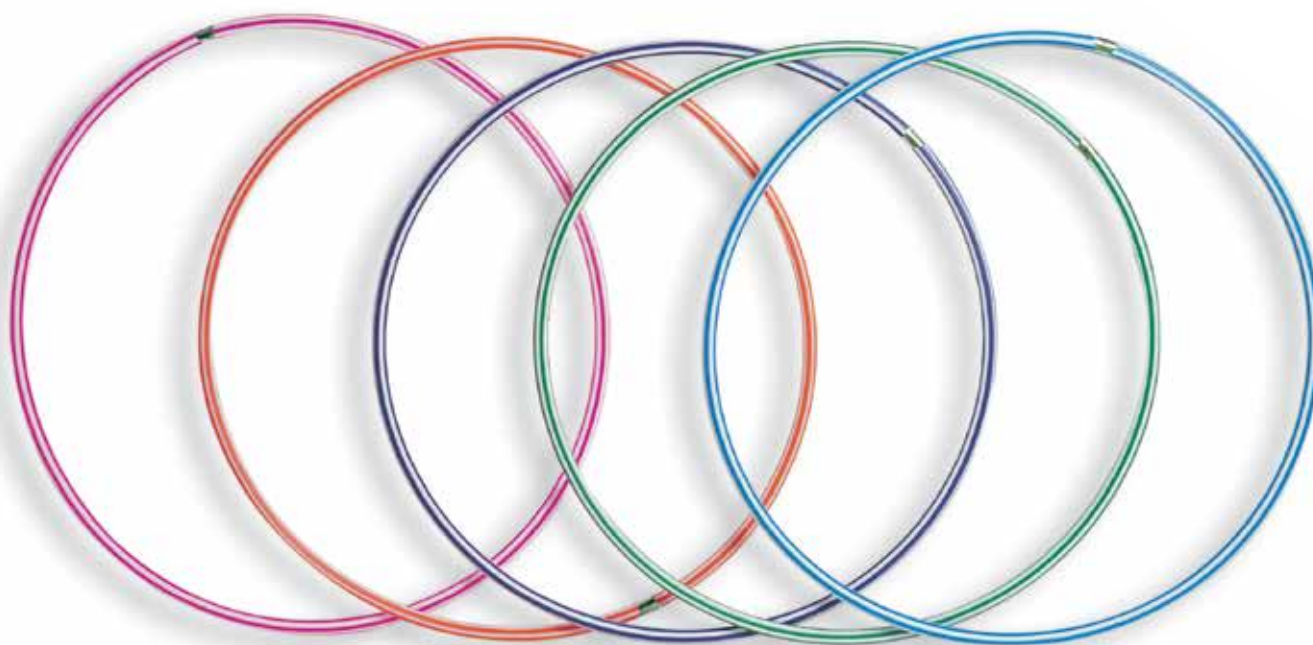

640 200 Hula Hoop 2 colores. Ø interior 72 cm. - Hula hoop 2 colors. Ø inner 72 cm.



439 912 Balancín 3 plazas. - Three-seater children's rocking.



442 700 Juego de bolos foam. - *Foam bowling.*



455 000 Juego de bolos foam recubiertos piel. - *Coated foam bowling.*



439 455 Juego de bolos en polietileno. - *Bowling set made of P.E.*



610 139 Set de 8 bolas de petanca y boliche. Diámetro de las bolas: 7,2 cm. Diámetro boliche: 3,3 cm. Fabricadas en material plástico PE. Con caja abierta para su transporte. *Set of 8 petanque balls and a small ball. Balls diameter: 7,2 cm. Small ball diameter: 3,3 cm. Made of PE plastic. With strong black transport case with handle and transparent plastic bag.*



610 141



610 140



610 140 Petanca de acero, Ø 73 mm. Set de 3 piezas. *Steel petanque, Ø 73 mm. Set 3 pieces.*

610 141 Petanca de acero, Ø 73 mm.. Set de 6 piezas. *Steel petanque, Ø 73 mm. Set 6 pieces.*





**440 000 PIEZAS AJEDREZ STANDARD**

Fabricadas en plástico rígido. Sin lastre. Altura del rey 9.75 cm. Con estuche duro para guardar las piezas.

**STANDARD CHESS PIECES**

Made of rigid plastic without ballast. King's height: 9.75 cm. Includes a hard case for storage.

**440 001 PIEZAS AJEDREZ LASTRADAS**

Fabricadas en plástico rígido. Con lastre. Adecuadas para jugar en exterior. Altura del rey 9.75 cm. Con estuche duro para guardar las piezas.

**HEAVY CHESS PIECES**

Made of rigid plastic with ballast. Suitable for outdoor play. King's height: 9.75 cm. Includes a hard case for storage.



**440 002 PIEZAS AJEDREZ SOFT**

Fabricadas en un material blando y flexible. Altura del rey 9.75 cm. Con estuche duro para guardar las piezas.

**SOFT CHESS PIECES**

Made of a soft and flexible material. King's height: 9.75 cm. Includes a hard case for storage.



**440 003 TABLERO AJEDREZ PLEGABLE**

Fabricado en material vinilo plastificado muy resistente. Medidas: 50,8 x 50,8 cm. Escaque de 5,7cm. Varios colores: Negro, Marrón, Azul, Verde, rojo y rosa.

**FOLDING CHESS BOARD**

Made of resistant vinyl. Board measures: 50,8 x 50,8 cm. 5,7 cm squares. Available colours: black, Brown, blue, green, red and pink.



**440006 CRONÓMETRO AJEDREZ PROFESIONAL**

Cumple con las regulaciones de la FIDE. Aplica correctamente el control de tiempo oficial FIDE. Añade un segundo periodo de tiempo justo después de acabarse el primero y una vez hecho el movimiento número 40. El color de la palanca indica hacia qué lado moverse, visible desde 10 metros de distancia.

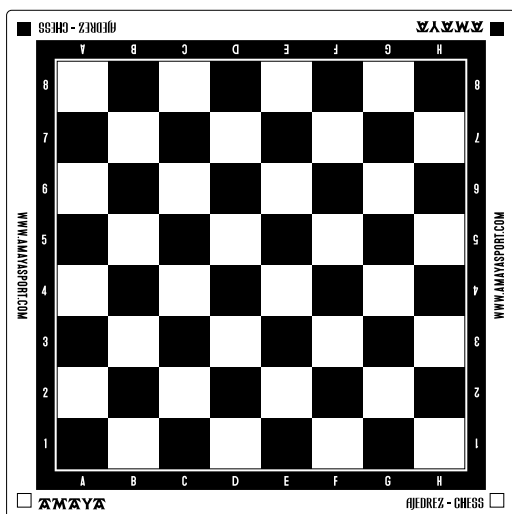

**440 004 TABLERO AJEDREZ PLÁSTICO**

Fabricado en material plástico semi-rígido. Medidas: 50 x 50 cm. Escaque de 5 cm.

**PLASTIC CHESS BOARD**

Made of semi-rigid plastic. Board measures: 50 x 50 cm. 5 cm squares.

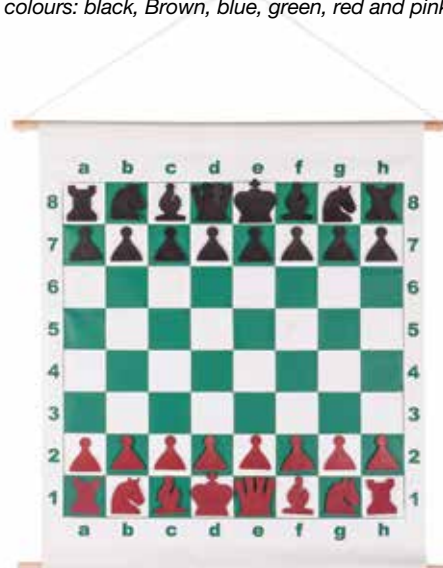

**440 005 TABLERO MASTER PARED MAGNÉTICO**

Tablero de demostración y aprendizaje. Medidas 76 x 64 cm. Color verde. Contiene piezas de ajedrez magnéticas.

**MAGNETIC CHESS DEMO BOARD**

Chess demonstration board for teaching. Board measures: 76 x 64 cm. Green colour. Comes with magnetic chess pieces.



**444 025** Juego de piezas gigantes de damas.  
Base: 24 cm. Altura: 10 cm  
*Giant checkers Set.*  
Base: 24 cm. Height: 10 cm.



**444 020** Juego de piezas gigantes de ajedrez. Altura Rey: 63,5 cm. Base: Ø 22 cm.  
*Giant chess set. King size: 63,5 cm. Base: Ø 22 cm.*

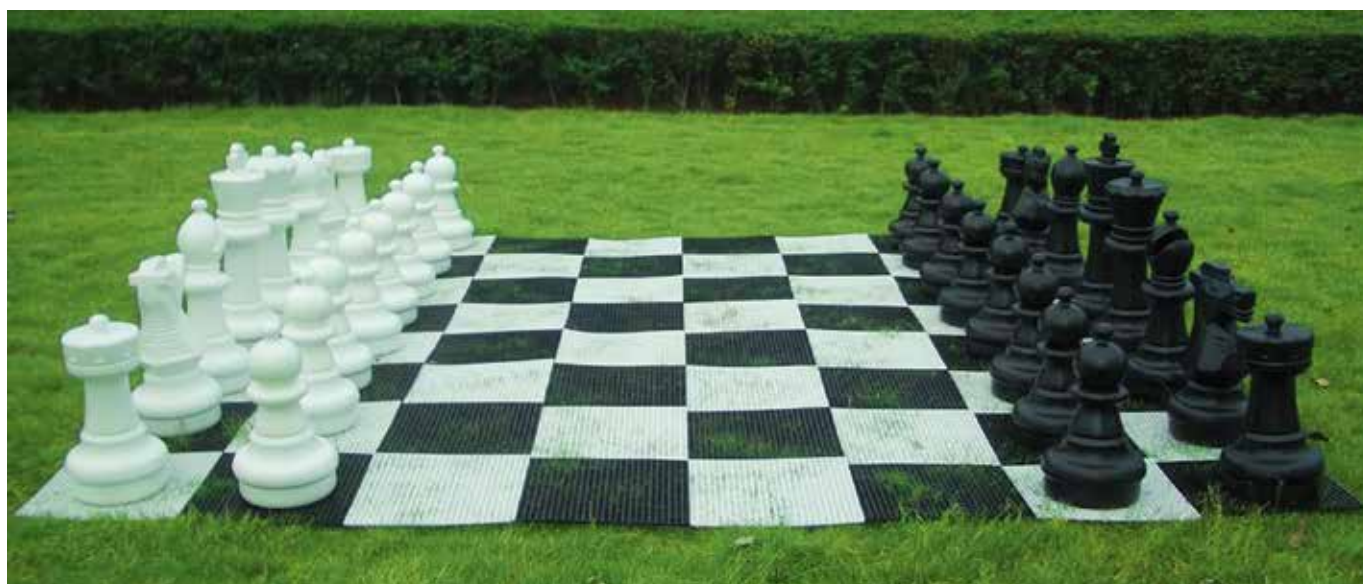

**444 030** Tablero de nylon para ajedrez o damas. Piezas no incluidas. Tablero de nylon tamaño: 274 x 274 cm.  
*Nylon giant board for chess and checker. Pieces not included. Dimensions: 274 x 274 cm.*





650 101 Disco caucho Ø 180 mm. - Rubber disk Ø 180 mm.



650 102 Disco caucho fantasía bicolor, Ø 180 mm.  
Rubber fantasy disk Ø 180 mm.



650 601 Mini-Boomerang.



442 600 Disco foam light Ø 220 mm. - Foam light freesbee Ø 220 mm.



442 802 Aro foam Ø 220 mm. - Foam flyer hoop Ø 220 mm.



442 800 Disco foam Ø 220 mm. - Foam freesbee Ø 220 mm.



454 600 Disco foam recubierto Ø 220 mm.  
Coated Foam freesbee O 220 mm.



650 300 Disco volador competición Ø 265 mm., peso 165 gr. - *Flying competition disk Ø 265 mm., 165 gr.*

650 400 Disco volador competición Ø 245 mm., peso 144 gr. - *Flying competition disk Ø 245 mm., 144 gr.*

650 500 Disco volador competición Ø 235 mm., peso 133 gr. - *Flying competition disk Ø 235 mm., 133 gr.*



650 104 Disco playa Ø 235 mm. - *Beach flying disk Ø 235 mm.*

650 103 Disco playa Ø 195 mm. - *Beach flying disk Ø 195 mm.*





**640 290** Indiaka Max. Fabricado en Foam PU blando con cinta de refuerzo. Peso: 60-65 gr. Anchura: 7,5 cm. Longitud total: 30 cm. Plumas: 4 u. longitud: 20 cm. tratadas con productos antiparásitos y desinfectantes. Únicas con homologación para uso escolar. A partir de 5 años.

*Indiaka Max.*

*Made of soft PU foam and reinforcement tape. Weight: 60-65g. Width: 7.5 cm. Total length: 30cm. Feathers: 4u. Length: 20cm Treated with antiparasitic and desinfectants products. Approved for school use. Up to 5 years*



**640 300** Indiaka. Fabricado en Foam PU con cinta. Longitud total: 30 cm. Plumas longitud 20 cm. Maleagridida. *Indiaka. Made of soft PU foam and reinforcement tape. Total length: 30cm. Feathers: 4u. Length: 20 cm. Maleagrid.. Approved for school use. Up to 5 years.*

**640 310** Repuesto pluma indiaka. Medida: 24 cm. - *Indiaka spare pen. Measure: 24 cm.*

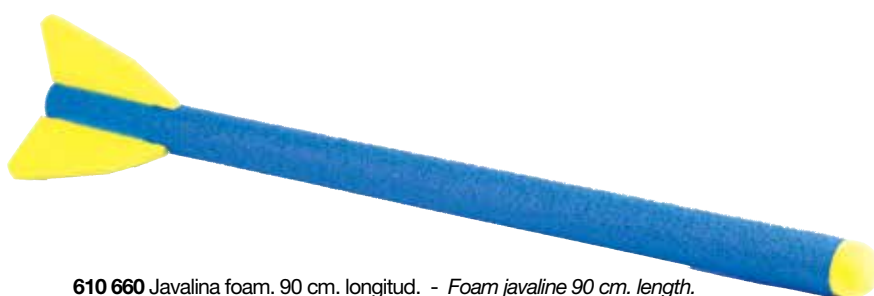

**610 660** Javalina foam. 90 cm. longitud. - *Foam javaline 90 cm. length.*



**640 350** Diana de madera de diámetro 43 cm. para colgar en la pared. Incluye 3 dardos de plástico blando anti-lesión de Longitud: 23.5 cm. Edad recomendada: A partir de 4 años.  
Diana Wood 43cm diameter. To hang on the wall. Includes 3 soft plastic darts anti-injury of Length: 23.5 cm. Recommended age up to 4 years.



**640 351** Diana de plástico de diámetro 38 cm. para colgar en la pared. Incluye 3 dardos de plástico blando anti-lesión de longitud: 17.5 cm.  
Diana Plastic 38 cm diameter. To hang on the wall. Includes 3 soft plastic darts anti-injury of Length: 17.5 cm.



**640 352** Diana de plástico de diámetro 30 cm. para colgar en la pared. Incluye 3 dardos de plástico blando anti-lesión de longitud: 17.5 cm.  
Diana Plastic 30 cm diameter. To hang on the wall. Includes 3 soft plastic darts anti-injury of Length: 17.5 cm.



**640 353** Dardos de 30,5 cm. Fabricados en plástico blando anti-lesión. Longitud 30,5 cm.  
Darts 30,5 cm. Made in soft plastic anti-injury. Length: 30,5 cm



**640 354** Dardos de 23,5cm. Incluye estuche para 24 u. Fabricados en plástico blando anti-lesión. Longitud 23,5 cm.  
Darts 23,5 cm. Includes case for 24u. Made in soft plastic anti-injury. Length: 23,5 cm



**443 905** Misil foam. Ø 8 cm. x 28 cm. longitud.  
Foam misil. Ø 8 cm. x 28 cm. length.





63025000 Racket Disk - Disco raqueta pequeño 30 cm.

63025100 Racket Disk - Disco raqueta grande 40 cm.



JUEGOS Y DEPORTES ALTERNATIVOS - GAMES AND ALTERNATIVE SPORTS



**630 600** Set raquetas malla. - *Net racket set.*



**630 300** Pon-pon Ø 65 mm., 25 gr. - *Pom-pom Ø 65 mm., 25 gr.*  
**630 301** Pon-pon Ø 85 mm., 48 gr. - *Pom-pom Ø 85 mm., 48 gr.*

**PELOTA POMPÓN SILICONA - POM POM BALL SILICONE**

La pelota Pompón es fácil de tirar, atrapar, y simplemente muy divertida. Es perfecto para jugar además de poder utilizarse para terapia y necesidades especiales. Color arcoíris. Fabricado en silicona muy agradable al tacto y fácil de limpiar.

*The Pom Pom ball is easy to throw, catch, and simply great fun. It is perfect for playing, as well as for therapy and special needs purposes. Rainbow color. Made of silicone very pleasant to the touch and easy to clean.*



**630 303** Pelota Pompón Silicona 85mm.  
 Material silicona, 62 g, 85mm.  
**Pom Pom Ball Silicone 85 mm.**  
 Made of silicone Ø 85 mm 62 g.



**630 302** Pelota Pompón Silicona 65mm.  
 Material silicona, 35 g, 65mm.  
**Pom Pom Ball Silicone 65 mm.**  
 Made of silicone Ø 65 mm 35 g.



**630 705** Volante gigante. Altura 17 cm.  
 Anchura volante 14,5 cm. Diámetro cabeza 65 mm.  
 Peso 50 g. *Giant shuttlecock.*



**630 700** Set raquetas paddle playa. Fabricada en plástico rígido.  
 Peso 284 g. Longitud: 39,3 cm. Anchura: 18,5 cm. Grosor 4 cm.  
*Beach paddle racket set. Made of solid plastic.*  
 Weight: 284 g. Length: 39,3 cm. Width: 18,5 cm. thickness: 4 cm.



**610 635** Set Shut con volante gigante.  
*Set shut with giant shuttlecock.*





**630 601** Set raquetas playa ligera. Longitud 42,5 cm. Anchura 10 mm.  
Peso 315 g. - Beach racket set.



**630 602** Set de 2 raquetas con pelota. Fabricada en madera rígida.  
Longitud 35 cm. Anchura 20 cm. Peso 650 g.  
*Wood beach racket set. 2 rackets and a ball.*



**630 605**  
Palas EVA soft + pelota  
Set de palas EVA super suaves. Buena sensación de golpe. Resistentes a la humedad, sirven tanto para exterior como para interior. Ideales para iniciación. Medidas 35 x 20,5 x 2 cm.

*Eva Raquets + ball.  
Set of soft eva rackets . For outdoor and indoor. Recommended for initiation. Measures 35 x 20.5 x 2 cm.*



**640 408** Cometa modelo FÉNIX

Varillas de fibra y tejido de nylon. Medidas: 160 x 80 cm.  
 Dos hilos de polipropileno. Con bolso para plegado y transporte. A partir de 8 años.  
*Fenix Kite . Fiber rods and nylon fabric. Measurements: 160 x 80 cm. Two polypropylene threads. Carrying bag. Up to 8 years.*



**640 406** Cometa modelo MILANO

Varillas de fibra y tejido de nylon. Medidas: 120 x 60 cm.  
 Dos hilos de polipropileno. Con bolso para plegado y transporte. A partir de 8 años.  
*Milano Kite. Fiber rods and nylon fabric. Measurements: 120x60cm. Two polypropylene threads. Carrying bag. Up to 8 years.*



**640 410** Cometa - AGUILA

Varillas de fibra y tejido de nylon. Medidas: 115 x 70 cm.  
 Dos hilos de polipropileno. Con bolso para plegado y transporte. A partir de 8 años.  
*Aguila kite. Fiber rods and nylon fabric. Measurements: 115x70cm. Two polypropylene threads. Carrying bag. Up to 8 years.*



**640 407** Cometa modelo CÓNDROR

Varillas de fibra y tejido de nylon. Medidas: 120 x 60 cm.  
 Dos hilos de polipropileno. Con bolso para plegado y transporte. A partir de 8 años.  
*Condor kite. Fiber rods and nylon fabric. Measurements: 120x60cm. Two polypropylene threads. Carrying bag. Up to 8 years.*



**640 416** Cometa DIAMANTE DRAGÓN

Varillas de fibra y tejido de nylon. Medidas: 75 x 45 cm. Hilo de nylon con agarradera. A partir de 6 años.  
*Diamond dragon kite. Fiber rods and nylon fabric. Measurements: 75 x 45 cm. Nylon thread with handle. Up to 6 years.*



**640 417** Cometa DIAMANTE GLOBO

Varillas de fibra y tejido de nylon. Medidas: 75 x 45 cm. Hilo de nylon con agarradera. A partir de 6 años.  
*Diamond balloon kite. Fiber rods and nylon fabric. Measurements: 75 x 45 cm. Nylon thread with handle. Up to 6 years.*



**640 415** Cometa - DIAMANTE

Varillas de fibra y tejido de nylon. Medidas: 75 x 45 cm. Hilo de nylon con agarradera. A partir de 6 años.  
*Diamond kite. Fiber rods and nylon fabric. Measurements: 75 x 45 cm. Nylon thread with handle. Up to 6 years.*



## ECO Balones - ECO Balls

100 % ecológicos. Nuevo material. Suave, hinchable y sin P.V.C. Impacto ambiental cero. Biodegradable, reciclable y no contaminante.

Cumplen la normativa europea EN-71 del juguete: no tóxico, no inflamable y no peligroso para menores de 3 años.

*100 % ecologics. New material. Soft, inflatable and without P.V.C. Nule environmental impact. Biodegradable, recyclable and not contaminable. According with european norm EN-71 for toys: not toxicity, not inflamable, not dangerous for babies.*

**665 650** Eco balones Ø 160 mm. *Eco balls Ø 160 mm.*

**665 666** Eco balones Ø 180 mm. *Eco balls Ø 180 mm.*

**665 667** Eco balones Ø 210 mm. *Eco balls Ø 210 mm.*

**665 668** Eco balones Ø 230 mm. *Eco balls Ø 230 mm.*





700 322 Balón cristal, Ø 140 mm. - *Cristal ball Ø 140 mm.*



700 315 Balón nácar, Ø 220 mm. - *Nacred ball Ø 220 mm.*



700 324 Balón hinchable espuma ultraligero, Ø 220 mm. Blister.  
*Inflatable Ø 220 mm. Blister. Light foamed PVC ball.*



700 416 Pelota mágica Ø 130 mm. No necesitan hincharse. - *Magic ball Ø 130 mm. No needed blow up.*

700 417 Pelota mágica Ø 160 mm. No necesitan hincharse. - *Magic ball Ø 160 mm. No needed blow up.*





**700 230** Balón decorado fútbol modelo Super-5, Team y Furia, Ø 220 mm.  
Football mod. "Super-5""Team" and "Furia" Ø 220 mm.

**700 234** Balón multideporte termoplástico  
Ø 180 mm. 150 gr.  
Thermo-plastic multisport ball Ø 180 mm. 150 gr.



**800 375** Pelotas minideportivos termoplástico Ø 100 mm.  
Thermo-plastic balls PVC Ø 100 mm.



**464 400 00** Pelota relieve Ø 100 mm. Estuche de 12 unidades.  
- Relief ball Ø 100 mm. Blister 12 u.



**800 379** Pelota cristal Ø 100 mm. Estuche de 12 unidades. - Cristal  
ball Ø 100 mm. Blister 12 u.

RECOMENDADOS PARA MENORES DE 3 AÑOS. - RECOMENDED FOR CHILDREN UNDER 3 YEARS.



**800 340** Pelota fantasía cascabel Ø 70 mm. - Fantasy bell ball Ø 70 mm.

**800 341** Pelota fantasía cascabel Ø 55 mm. - Fantasy bell ball Ø 55 mm..

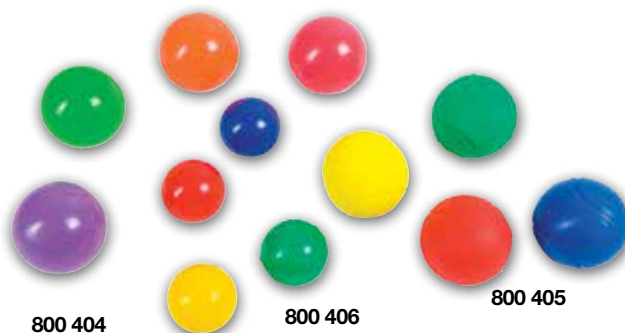

**800 404**

**800 406**

**800 405**

**800 404** Pelota esponja termoplástico blanda Ø 55 mm. Hueca  
*Foamed thermo-plastic ball Ø 55 mm. soft.*

**800 405** Pelota esponja termoplástico blanda Ø 55 mm. Dibujo tenis. Hueca  
*Foamed thermo-plastic ball Ø 55 mm. soft.*

**800 406** Pelota esponja termoplástico blanda Ø 40 mm.  
*Foamed thermo-plastic ball Ø 40 mm. soft.*

Anti-Stress. A partir de 3 años.

**800 435** Pelota Ø 60 mm.

**800 436** Pelota Ø 70 mm.

**800 423** Pelota rugby.



**800 395** Pelotas basket esponja caucho ø 50 mm.  
*Basket rubber-foam ball ø 50 mm.*



## MUNDO ANIMAL

Figuras de gran realismo. Fabricadas con materiales y pinturas no tóxicas acordes a la normativa europea. A partir de 3 años.

ANIMAL WORLD. Realistic figures. Made with no-toxic materials and paints, according with the european normative. From 3 years old.



### 800 601 Set animales

Tigre, rinoceronte, hipopótamo, hiena, gacela y lince.  
Tiger, rhinoceros, hippopotamus, hyena, gazelle and lynx.



### 800 602 Set animales

León, puma, lobo, oso polar, ciervo y oso pardo.  
Set animals. Lion, cougar, wolf, polar bear, deer and brown bear.



### 800 603 Set animales

Canguro, oso panda, camello, gorila, mapache, koala y coyote.  
Set animals. Kangaroo, panda bear, camel, gorilla, raccoon, koala and coyote.



### 800 604 Set animales

Cerdo, conejo, gato, urogallo, avestruz, gallina, mula y oveja.  
Set animals. Pig, rabbit, cat, grouse, ostrich, chicken, mule and sheep.



### 800 605 Set animales

Pastor alemán, caballo, vaca, toro, cabra, llama y pavo.  
Set animals. German shepherd, horse, cow, bull, goat, llama and turkey.



### 800 606 Set animales

Ardilla, ciervo, pantera, cabra montesa, jabalí, zorro, búfalo y buey.  
Set animales. Ardilla, ciervo, pantera, cabra montesa, jabalí, zorro, búfalo y buey.



### 800 607 Set animales

Águila, loro, tucán, halcón, pato, cigüeña, condor, lechuga, cisne, cacaatúa, pelicano y flamenco.  
Set animals. Eagle, parrot, toucan, hawk, duck, stork, condor, owl, swan, cockatoo, pelican and flamingo.



### 800 608 Set animales

Jirafa, chimpancé, elefante, leopardo y cebra.  
Set animals. Giraffe, chimpanzee, elephant, leopard and zebra.



### 800 609 Set animales

Ballena, tiburón, delfín, pingüino, foca, nutria y castor.  
Set animals. Whale, shark, dolphin, penguin, seal, otter and beaver.



# 4

## MALABARES Y JUEGOS DE HABILIDAD *JUGGLING AND HABILITY GAMES*





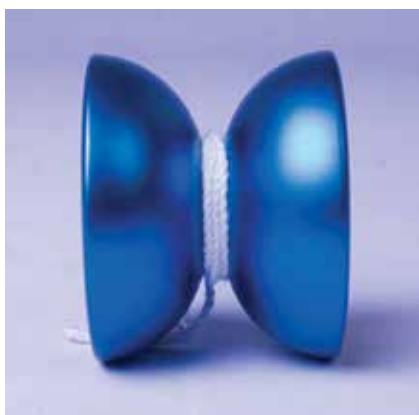

**620 708**

Yoyo Typhoon. Yoyo profesional fabricado en aluminio. Rodamiento de alta velocidad tipo K, cóncavo. Diámetro 54 mm. Anchura 42 mm. Cuerda de 8 filamentos técnicos. Tiempo de ralenti largo. Peso 68 gr. Con enganche, tapas, puntas y dado para la realización de trucos de exhibición.

*Professional Yoyo made of aluminium. High speed concave bearing K-type. Cord with 8 technics fibres. Time of holding in slow motion is long. Ø 54 mm., width: 42 mm., weight: 68 gr. Contents: grip, covers, stoppers and dice.*



**620 706**

Yoyo Flying Master. Yoyo profesional fabricado en aluminio de alta velocidad K, cóncavo. Ø 53,3 mm. Ancho: 40 mm. Cuerda de 8 filamentos técnicos. Tiempo de ralenti largo. Peso 68 gr.

*Professional Yoyo made of aluminium. High speed concave bearing K-type. Time of holding in slow motion is long. Cord with 8 technics fibres. Ø 53.3 mm., width: 40 mm., weight: 68 gr.*



**620 711**

Yoyo Jumbo. Yoyo profesional fabricado en aluminio. Rodamiento de alta velocidad K, cóncavo. Ø 52 mm. Ancho 39 mm. Cuerda de 8 filamentos técnicos. Tiempo de ralenti largo. Peso: 66 gr.

*Professional Yoyo made of aluminium. High speed concave bearing K-type. Time of holding in slow motion is long. Cord with 8 technics fibres. Ø 52 mm., width: 39 mm., weight: 66 gr.*



**620 709**

Yoyo Hunt Eagle. Yoyo avanzado, fabricado en resina y aluminio. Rodamiento de alta velocidad K, cóncavo. Ø 54 mm. Ancho 40 mm. Peso 68 gr. Cuerda de 8 filamentos técnicos. Tiempo de ralenti alto.

*Advanced profesional yoyo , made of resin and aluminium. High speed concave bearing K-type. Time of holding in slow motion is long. Cord with 8 technics fibres. Ø 54 mm., width: 40 mm., weight: 68 gr.*



**620 705**

Yoyo Snow Fox. Yoyo avanzado, fabricado en acero. Ø 58 mm. Ancho 34 mm. Peso 68 gr. Yoyo de alta velocidad. Cuerda de 8 filamentos técnicos. Tiempo de ralenti medio.

*Advanced profesional yoyo , made of steel. High speed bearing. Time of holding in slow motion medium. Cord with 8 technics fibres. Ø 58 mm., width: 34 mm., weight: 68 gr.*



**620 710**

Yoyo Flip&Roll. Yoyo de aprendizaje. Fabricado en resina. Con rodamiento. Ø 52 mm. Ancho 38 mm. Peso 56 gr. Cuerda de 8 filamentos técnicos. Tiempo de ralenti medio.

*Initiation yoyo , made of resin. Time of holding in slow motion medium. Cord with 8 technics fibres. Ø 52 mm., width: 38 mm., weight: 56 gr.*



**620712**

Yoyo Red Bird. Yoyo de iniciación automático, con autoretorno. El yoyo perfecto para los más pequeños. Ø 55 mm. Peso 47 gr.

*Initiation yoyo , with automatic return. Best-suited for little children. Ø 55 mm., weight: 47 gr.*





**620 702**  
Yoyo Competición Ø 60 mm. - *Competition yo-yo Ø 60 mm.*



**620 701**  
Yoyo Tornado.



**620 700**  
Yoyo Fantastic.



**620 713**  
Cuerdas Yoyo.  
Ropes.



**620 714**  
Lubricante Yoyo.  
Lubricant.

YOYOS



**620 202** Diábolo profesional caucho, Ø 105 mm. Con palos de madera. En estuche de cartón.  
- Diabolo rubber, Ø 105 mm. With wood sticks. In a paperboard box.



**620 203** Diábolo profesional caucho fantasía, Ø 105 mm. Con palos de madera. En estuche de cartón. Diabolo rubber fantasy, Ø 105 mm. With wood sticks. In a paperboard box.



**620 206** Diábolo profesional caucho fantasía 105 mm. Con palos de madera. En blister. Incluye DVD. Diabolo rubber fantasy, Ø 105 mm. with woodsticks. In Blister, includes DVD.

**620 209** Diábolo profesional caucho fantasía 105 mm. Con palos de fibra de vidrio. En Blister. Incluye DVD. Diabolo rubber fantasy, Ø 105 mm. With fiber sticks. In Blister, includes DVD.



**620 205** Diábolo profesional caucho 105 mm. Con palos de madera. En blister. Incluye DVD de aprendizaje. Diabolo rubber, Ø 105 mm. with woodsticks. In blister. Includes learning DVD.

**620 207** Diábolo profesional caucho 105 mm. En blister. Con palos de fibra de vidrio y DVD. Diabolo rubber, Ø 105 mm. In blister. With fiber sticks and learning DVD.



## DIÁBOLOS CON RODAMIENTO

La revolución en el mundo de los diabólos. Trucos imposibles de realizar con un diábolo tradicional. En su eje, incorpora 3 rodamientos, uno axial con giro en un único sentido, y dos rodamiento de bolas de precisión. Silencioso, y de giro continuo a gran velocidad.

Fabricado en material sintético indeformable. El eje esta fabricado en materiales de gran calidad y duraderos, con tratamientos anti corrosión.

## DIABOLOS WITH BEARING

Possible to perform new tricks. In his shaft incorporates a thrust bearing to spin in one direction and two precision ring bearings. Silent and with continuous rotation speed. Keep its shape. Shaft made of anti-corrosion material.



**620 214** Diábolo transparente con rodamientos 130 mm. Peso: 275 Altura: 155mm Diámetro: 130 mm.  
*Diabolo with bearing 130 mm. Weight: 275 g Height:155 mm Diameter: 130mm*



**620 212** Diábolo transparente con rodamientos 100 mm. Peso: 215 Altura: 125mm Diámetro: 100 mm.  
*Diabolo with bearing 100 mm. Weight: 215 g Height:125 mm Diameter: 100 mm.*

**620 215** Diábolo transparente con rodamientos 100 mm. Peso: 215 Altura: 125mm Diámetro: 100 mm. Con palos de fibra de vidrio. En Blisters. Incluye DVD.

*Diabolo with bearing 100 mm. Weight: 215 g Height:125 mm Diameter: 100 mm. With fiber sticks. In Blisters. Includes DVD.*



DIABOLOS



**620 210** Diábolo rodamientos transparente Ø 80 mm. 140 gr. No incluye dos rodamientos de bolas, únicamente el axial.  
*Diabolo with bearing 80 mm. Weight: 130 g Height:105 mm Diameter: 80 mm.*

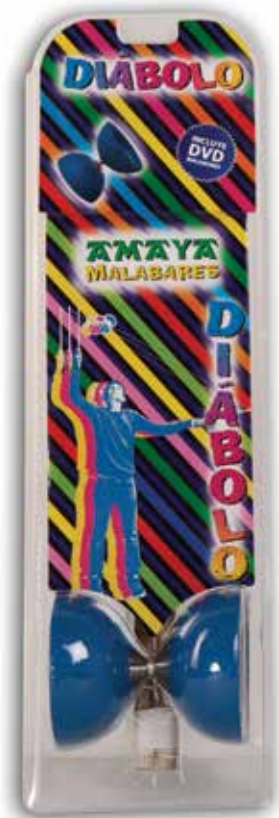

620 204



**620 191** Diábolo semiesférico termocaucho, Ø 105 mm. Con palos de madera. Estuche de cartón.  
*Diabolo thermorubber semispherical, Ø 105 mm. With wood sticks. Boardpaper box.*

**620 204** Diábolo semiesférico termocaucho, Ø 105 mm. Con palos de madera. Incluye DVD de aprendizaje.  
*Diabolo thermorubber semispherical, Ø 105 mm. Includes a learning DVD.*

**620 208** Diábolo semiesférico termocaucho, Ø 105 mm. Con palos de fibra de vidrio y DVD.  
*Diabolo thermorubber semispherical, Ø 105 mm. With fiber sticks and learning DVD.*



**620 192** Diábolo semiesférico termocaucho, Ø 130 mm. con palos de madera. - *Diabolo thermorubber semispherical Ø 130 mm. With wood sticks.*

**620 195** Diábolo semiesférico termocaucho, Ø 130 mm. Con palos de fibra de vidrio. *Diabolo thermorubber semispherical, Ø 130 mm. With fiber sticks.*

**620 190** Diábolo termocaucho 80 mm. con palos de madera. Estuche de cartón. *Diabolo thermorubber semispherical, Ø 80 mm. With wood sticks. Boardpaper box.*

**620 193** Diábolo semiesférico termocaucho, Ø 80 mm. Con palos de fibra de vidrio. *Diabolo thermorubber semispherical, Ø 80 mm. With fiber sticks.*



**620 100** Diábolo EVA semiesférico.  
*Diabolo EVA semispherical.*



**620 250** Palos de diábolo de aluminio. Incluye cuerda.  
*Aluminium diabolo sticks. Rope included.*



**620 252** Palos de diábolo de carbono. Incluye cuerda.  
*Carbon diabolo sticks. Rope included.*



**620 251** Palos de diábolo de fibra. Incluye cuerda.  
*Fiber diabolo sticks. Rope included.*







**640 910** Pelotas malabares PVC.  
*Juggling balls PVC.*



**640 909** Pelotas malabares piel multicolor interior semillas Ø 65 mm.  
*Multicolor leather juggling ball with seeds, Ø 65 mm.*



**640 936** Gravity contact ball 75 mm. Luminescente.  
Bola acrílica de escena de doble inyección ideal para efectos gravitatorios. Material de gran resistencia. - *Acrylic scene ball made with double injection for gravitational effects. High resistance material.*



**640 935** Gravity contact ball 75 mm.  
Bola acrílica de escena de doble inyección ideal para efectos gravitatorios. Material de gran resistencia. - *Acrylic scene ball made with double injection for gravitational effects. High resistance material.*

**MALABARES - JUGGLING**



**640 911** Mazas malabares. - *Juggling clubs.*



**640 920** Mazas malabares butterfly. Maza de malabares profesional con perfecto centro y equilibrio.  
*Butterfly juggling clubs. Profesional juggling clubs with perfect core and balance.*



**640 917** Flower sticks



**640 913** Pañuelos malabares 70 x 70 cm. - Handkerchiefs 70 x 70 cm.

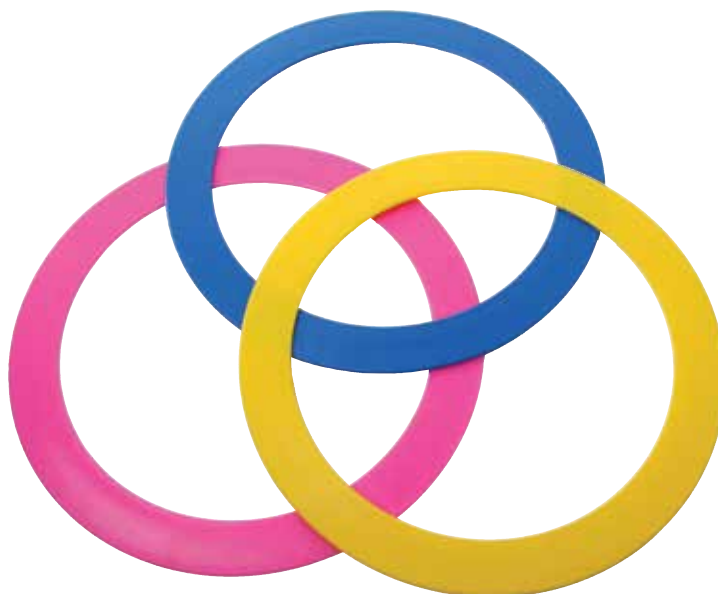

**640 912** Aros malabares. - Juggling hoops.





640 900 Quick cups. Set de 12 unidades con bolsa. - *Quick cups. Set 12 units in a bag.*  
640 901 Alfombrilla especial. - *Special mat.*



620 300 Disco chino. - *Chinese disk.*



JUEGOS DE HABILIDAD - *HABILITY GAMES*



**640 456 PEONZA IRON TURBO**

Peonza Aluminio IRON TURBO. Con rodamiento.  
*IRON TURBO Aluminium Spinning top.*



**640 450 PEONZA PS X-TOP**

Peonza PS X-TOP en colores. Interior hueco. Longitud 80 mm.  
*PS X-TOP coloured Spinning top. Empty inside. Length: 80 mm.*



**640 454 PEONZA DRAGÓN TURBO**

Peonza DRAGÓN TURBO con rodamiento. Múltiples colores. Interior hueco. Longitud 80 mm.  
*DRAGON TURBO Spinning top. Empty inside. Length: 80 mm.*



**640 455 PEONZA ROCKET TURBO**

Peonza PS ROCKET TURBO bicolor con rodamiento. Longitud 80mm. PS COHETE TURBO with spinning top. Length: 80mm



**640 452 PEONZA PS SATURNO**

Peonza PS SATURNO bicolor. Múltiples combinaciones. Interior hueco. Longitud 80 mm.  
*PS SATURNO bicolor Spinning top. Empty inside. Length: 80 mm.*





**640 915** Monociclo freestyle. Horquilla de aluminio, llanta en p.v.c. Sillín en p.v.c.acolchado con refuerzos. Pedales en p.v.c.antideslizante. Rueda de 20" = 51 cm. Especial para aprendizaje.

*Freestyle unicycle. Aluminium fork, p.v.c. rim. Padded p.v.c. saddle with reinforcement. p.v.c. non slip pedals. 20" = 51 cm wheel. Special for learning.*



**640 914**

Conjunto de Cariocas para la realización de ejercicios escénicos y de coordinación. Juego muy divertido. Sistema de sujeción a los dedos de forma segura. Longitud de la cuerda regulable.

*Set of poi for performing and coordination scenic exercises. This is a great amusing game. Special security grip for fingers. The cord can be adjusted in several lengths.*



**640 925 PEDALÍN**

Con 6 ruedas antideslizantes.

Medidas: 41 x 35 cm. Diámetro rueda: 15 cm.

Peso: 2.5 kg. Peso máximo usuario: 90 kg.

*PEDALÍN. with 6 nonslip wheels.*



# PRO SLACKLINE

by AMAYA



## 640 927 PRO SLACKLINE CLASSIC

El slacline ideal para principiantes. 15 metros de largo (2 partes). 50mm de ancho. Elasticidad máxima del 9%. Nivel de rotura de 4.000 Kg.

### PRO SLACKLINE CLASSIC

For beginners. 15 m long, 50 mm wide  
9% elasticity. Breakpoint until 4.000 Kg

## 640 929 PROTECTOR ARBOL PRO SLACKLINE

Diviértete en la naturaleza, pero respétala. Usa siempre los protectores de árbol de Pro Slack line. 2 tiras de 120 x 14 cm fabricadas en fieltro.

### TREE PROTECTION FOR PRO SLACKLINE

Enjoy nature but with respect. Tree protection is an absolute must for all slackliners. 2 strips of felt, 120x14 cm.



## 640 930 ESTRUCTURA SLACKLINE

Estructura para Pro Slackline. Fabricada en acero recubierto con pintura epoxi de gran resistencia. MEDIDAS : longitud 4 metros. Alto 60 cm , Ancho 65 cm. Especialmente indicado para las escuelas y clubes deportivos.

### STRUCTURE FOR PRO SLACKLINE

Made of powder-coated steel. 4 m long, 60 cm high, 65 cm wide. Suitable for schools and clubs.



**JUEGOS DE AGUA  
Y NATACIÓN**

***WATER GAMES  
AND SWIMMING***

**5**





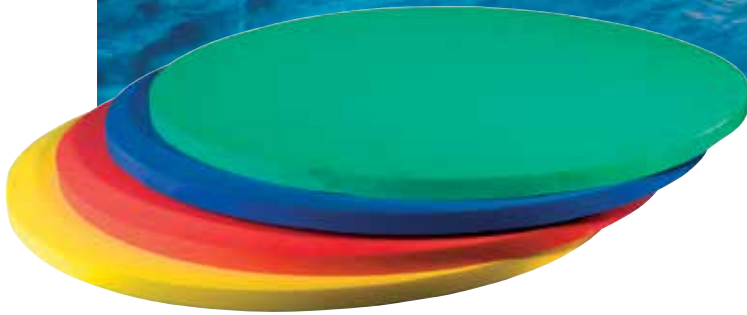

660 960 Tapiz circular Ø 1 metro x 4 cm. - Round water carpet Ø 1 m x 4 cm.



660 950 Tapiz rectangular de 200 x 100 x 2 cm. - Water carpet 200 x 100 x 2 cm.

660 951 Tapiz rectangular de 200 x 100 x 4 cm. - Water carpet 200 X 100 X 4 cm.

660 952 Tapiz rectangular de 200 x 100 x 9 cm. - Water carpet 200 X 100 X 9 cm.





**660 953** Tapiz rectangular con agujeros. De 100 x 66 x 2 cm. - *Water carpet with holes 100 x 66 x 2 cm.*  
**660 954** Tapiz rectangular con agujeros. De 200 x 100 x 2 cm. - *Water carpet with holes 200 x 100 x 2 cm.*



**660 915** Barra flotante, Ø 65 mm., longitud 1,50 m.  
*Floating bars Ø 65 mm. length. 1,50 m.*

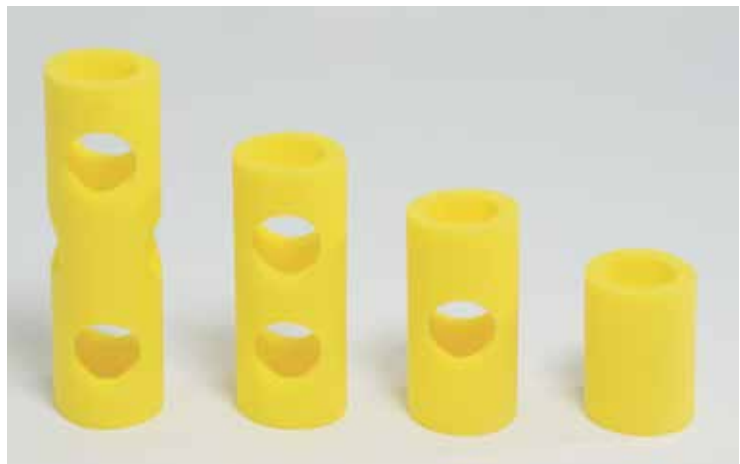

**660 911** Conectores. - *Connectors* Ø 100 x 140 mm.  
**660 912** Conectores. - *Connectors* Ø 100 x 200 mm.  
**660 913** Conectores. - *Connectors* Ø 100 x 250 mm.  
**660 914** Conectores. - *Connectors* Ø 100 x 332 mm.



**660 970** Pullboy.



**660 965** Cinturón flotante grande. 76 x 29 x 3,8 cm. - *Big floating belt 76 x 29 x 3,8 cm.*

**660 967** Cinturón flotante pequeño. 64 x 26 x 3,8 cm. - *Small floating belt 64 x 26 x 3,8 cm.*



**660 993** Aletas de natación de silicona S (36-37).  
*Silicone swimming flippers S (36-37).*



**660 995** Aletas de natación de silicona M (38-40).  
*Silicone swimming flippers M (38-40).*

**660 996** Aletas de natación de silicona L (41-43).  
*Silicone swimming flippers L (41-43).*



**660 990** Manoplas de natación. - *Swimming paddle.*





**660 931** Cangrejo. Medidas: 66 x 50 cm. agujero de 24 cm.  
*Crab. Meassure: 66 x 50 cm. Hole Ø 24 cm.*



**660 932** Lancha. Medidas: 66 x 50 cm. agujero de 24 cm.  
*Launch. Meassure: 66 x 50 cm. Hole Ø 24 cm.*



**660 933** Tortuga. Medidas: 66 x 50 cm. agujero de 24 cm.  
*Tourtle. Meassure: 66 x 50 cm. Hole Ø 24 cm.*



**660 930** Tiburón. Medidas: 66 x 50 cm.  
*Shark. Meassure: 66 x 50 cm.*



660 971 Gorro natación de poliéster. - Polyester bathing cap.



660 972 Gorro natación de latex. - Latex bathing cap.

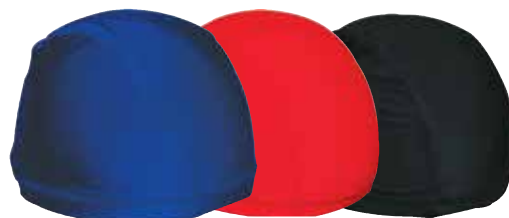

660 973 Gorro natación de licra. -Lycra bathing cap.



660 974 Gorro natación de silicona. - Silicone bathing cap.



660 976 Gorro natación de PU. Nuevo material. Tela recubierta de Poliuretano. Muy cómodo de colocar. Material anti-tirones. PU coated bathing cap.



660 975 Gorro natación de silicona reversible en dos colores. - Silicone two colors bathing cap. Useful two sides.





660 980 Gafas natación infantil classic. - Children's classic swimming goggles.



660 981 Gafas natación infantil visión completa. - Children's complete vision swimming goggles.

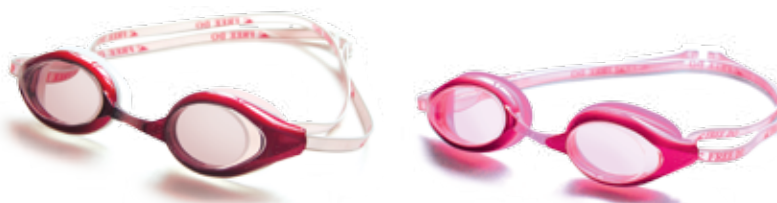

660 982 Gafas natación adulto classic. - Adult's classic swimming goggles.



660 983 Gafas natación adulto visión completa. - Adult's complete vision swimming goggles.



660 999 Tapón nariz. - Nose plug



660 998 Tapones oído-orejas. - Earplug.



650 200 Disco acuático. - Water disk.



660 903 Red de voley flotante, 186 x 100 cm.  
Floating volley net, 186 x 100cm.



660 902 Portería waterpolo flotante, 90 x 70 x 60 cm.  
Floating waterpolo goal, 90 x 70 x 60 cm.



660 904 Cesta de basket flotante, Ø 52 cm., altura 40 cm.  
Floating basket, Ø 52 cm., height 40 cm.



700 225 Balón waterpolo caucho celular. Lámina de caucho en una única pieza. Peso: 365 a 385 gr. Ø 219 - 225 mm. Recomendado para entrenamiento y competición.  
Waterpolo celular rubber ball. Weight: 365 to 385 gr. Ø 219 - 225 mm. Suitable for training and competition.





- 660 200** Flotador liso exterior Ø 85 cm. - Plain float outside ext Ø 85 cm.
- 660 300** Flotador rugoso Ø interior 180 mm. - Rugged float inner. Ø 180 mm.
- 660 400** Flotador rugoso Ø interior 210 mm. - Rugged float inner. Ø 210 mm.
- 660 500** Flotador rugoso Ø interior 250 mm. - Rugged float inner. Ø 250 mm.



- 660 919** Pozal con cedazo y pala. - Cube with sieve and shovel.
- 660 920** Pozal. Fabricado en material muy flexible. Beach bucket, made of the most flexible material.
- 660 921** Cedazo. - Beach sieve.
- 660 922** Pala. - Beach shovel.



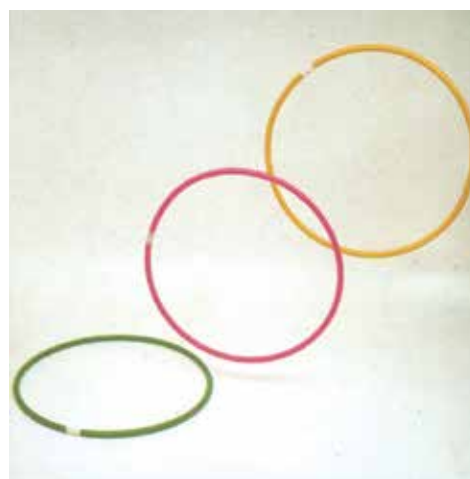

**660 600** Aros sumergibles 3 niveles, Ø 75 cm. Juego de 3 aros - *Underwater hoops 3 levels Ø 75 cm. Set of 3 hoops.*



**660 900** Ringo macizo Ø exterior 16 cm. - *Solid ringo Ø exterior 16 cm.*  
**660 901** Ringo hueco Ø exterior 16 cm. - *Empty ringo Ø exterior 16 cm.*

**660 700** Aros de buceo flexibles Ø 16 cm. - *Underwater flexible hoops Ø 16 cm.*



**660 916** Perlas de buceo Ø 70 mm. - *Underwater pearls Ø 70 mm.*

**660 916** Perlas de buceo Ø 70 mm. - *Underwater pearls Ø 70 mm.*  
**660 925** Set 6 picas de buceo. - *Underwater sticks. Set 6 u.*



**DEPORTES, ACCESORIOS  
Y COMPLEMENTOS**

***SPORTS, ACCESORIES  
AND COMPLEMENTS***

**6**





NOVEDADES TECNOLÓGICAS



**700 100 BALÓN FUTBOL modelo BURAN Talla 5**

Nuevo sistema de unión de los paneles. Cosido y termo-soldado. El cosido queda en el interior. Fabricado en cuero sintético 4 capas, capa externa Nuevo material trenzado denominado célula de abeja. Cámara y válvula de butilo de alta calidad. Nuevo núcleo interno para mayor equilibrio y control. Sistema interno anti-vibración. Válvula hinchable de butilo. Fabricado acorde a la normativa de la federación española.  
*New panel joining system. Sewed and glued by thermal eating. Inner lining: four layers with an internal core providing a better control and balance. Inner system vibration-isolated. Outer Cover: Synthetic leather and new twisted material called hive braiding. Bladder and valve: high quality butyl. Manufactured to comply with the regulation of the Spanish Federation.*



**700 000 BALÓN FUTBOL modelo YTERBIUM talla 5**

Balón de fútbol más rápido. Material c efecto muelle en su interior. Fabricado en cuero sintético cosido 4 capas, capa externa TPU. Cámara y válvula de butilo de alta calidad. Sistema interno anti-vibración. Válvula hinchable de butilo. Fabricado acorde a la normativa de la federación española.  
*FOOTBALL BALL YTERBIUM Size 5*  
*Fast and light Football ball. Internal core with spring effect. Made of synthetic leather with four layers and outer cover of TPU. Inner system vibration-isolated. Bladder and valve: high quality butyl. Manufactured to comply with the regulation of the Spanish Federation.*



**700 101 BALÓN FUTBOL modelo ETESIO talla 5**

Fabricado en cuero sintético cosido 4 capas, capa externa NUEVO MATERIAL TRENZADO DENOMINADO CÉLULA DE ABEJA. Cámara y válvula de butilo de alta calidad. Nuevo núcleo interno para mayor equilibrio y control. Sistema interno anti-vibración. Válvula hinchable de butilo. Fabricado acorde a la normativa de la federación española. *FOOTBALL BALL N.5 ETESIO*  
*Sewed synthetic leather, four layers with outer cover made of a new twisted material called hive braiding. Bladder and valve: high quality butyl. New internal core providing a better control and balance. Inner system vibration-isolated. Manufactured to comply with the regulation of the Spanish Federation.*



**700 103 BALÓN FUTBOL modelo ETESIO talla 4**

Fabricado en cuero sintético cosido 4 capas, capa externa NUEVO MATERIAL TRENZADO DENOMINADO CÉLULA DE ABEJA. Cámara y válvula de butilo de alta calidad. Nuevo núcleo interno para mayor equilibrio y control. Sistema interno anti-vibración. Válvula hinchable de butilo. Fabricado acorde a la normativa de la federación española.



**700 109 BALÓN FUTBOL modelo TAPSUS talla 5**

Fabricado en cuero sintético cosido 4 capas, capa externa TPU. Cámara y válvula de butilo de alta calidad. Nuevo núcleo interno para mayor equilibrio y control. Sistema interno anti-vibración. Válvula hinchable de butilo. Fabricado acorde a la normativa de la federación española.  
*FOOTBALL BAL N.5 TAPSUS*  
*Sewed synthetic leather, four layers with outer cover made of TPU. New internal core providing a better control and balance. Inner system vibration-isolated. Bladder and valve: high quality butyl. Manufactured to comply with the regulation of the Spanish Federation.*



**700 110 BALÓN FUTBOL modelo TAPSUS talla 4.**

Fabricado en cuero sintético cosido 4 capas, capa externa TPU. Cámara y válvula de butilo de alta calidad. Nuevo núcleo interno para mayor equilibrio y control. Sistema interno anti-vibración. Válvula hinchable de butilo. Fabricado acorde a la normativa de la federación española.  
*FOOTBALL BALL N.4 TAPSUS*  
*Sewed synthetic leather, four layers with outer cover made of TPU. New internal core providing a better control and balance. Inner system vibration-isolated. Bladder and valve: high quality butyl. Manufactured to comply with the regulation of the Spanish Federation.*





### 700 106 FUTBOL N°5 BREEZE

cuero sintético cosido. Interior: Tres capas de algodón y una capa de poliéster laminadas en látex natural. Exterior: Capa de cuero sintético. Vejiga de butilo. Peso y talla oficial. Recomendado para entrenamiento en campo de hierba.

FOOTBALL BALL N.5 BREEZE

*Sewed synthetic leather. Inner lining: two cotton layers and one polyester laminated in natural latex layer. Outer Cover: one PVC layer. Natural butyl bladder and valve. Thread: nylon 6.6 with double knot and crossed section. Weight: 310 gr. Official diameter. Recommended for training on grass pitches.*

### 700 118 FUTBOL N°5 CAPITAN

cuero sintético cosido. Interior: Tres capas de algodón y una capa de poliéster laminadas en látex natural. Exterior: Capa de cuero sintético. Vejiga de butilo. Peso y talla oficial. Recomendado para entrenamiento en campo de hierba.

FOOTBALL BALL CAPITAN N.5

*Sewed synthetic leather. Inner lining: two cotton layers and one polyester laminated in natural latex layer. Outer Cover: one PVC layer. Natural butyl bladder and valve. Thread: nylon 6.6 with double knot and crossed section. Weight: 310 gr. Official diameter. Recommended for training on grass pitches.*



### 700 104 BALÓN FÚTBOL N°5 PLATINUM

Cuero sintético cosido. tres capas de algodón y una capa de poliéster laminadas en latex natural. Exterior capa de PU. Vejiga de butilo. Altas prestaciones. Campo de hierba natural y artificial

FOOTBALL N. 5 PLATINUM

*Sewed synthetic leather. Inner lining: Three cotton layers and one polyester laminated in natural latex. Outer cover: P.U. layer. Bladder: butyl. Official size and weight. High performance qualities. Recommended for training on grass football pitch.*



### 700 117 BALÓN FÚTBOL N°4 PLATINUM.

Cuero sintético cosido. tres capas de algodón y una capa de poliéster laminadas en latex natural. Exterior capa de PU. Vejiga de butilo. Altas prestaciones. Campo de hierba natural y artificial



### 700 102 FUTBOL N°5 "SOFT TOUCH" 5 CAPAS. COMPETICIÓN

Laminación interna: 5 capas máxima calidad 80 % de butilo y nylon empastadas en latex natural. Capa más externa: Film de poliuretano con brillo. Sistema antilesión en el interior de las 5 capas. Cosido a mano. Vejiga: latex doble pared Hilo: nylon.6.6 con doble nudo y secciones completas cruzadas. Peso y diámetro oficial.

FOOTBALL N.5 SOFT TOUCH 5 LAYERS. HIGH COMPETITION

*Inner lining: Five high quality layers 80% butyl and nylon in natural latex. Outer cover: Shiny P.U. and padding effect. Hand sewn ball. Bladder: Double latex. Thread: nylon 6.6 with double knot and crossed section. Valve: Butyl, excellent air holding. Official weight and size.*



### 700 107 FUTBOL Nº5 CLASSIC

cuero brillante. Laminación interna: compuesta por dos capas de algodón y una capa de poliéster laminadas en látex natural. Laminación externa: compuesta de una capa de PVC. Recomendado para iniciación y entrenamiento en campo de hierba.

#### FOOTBALL BALL CLASSIC N.5

Football ball N.5 Classic model, shiny leather. Inner lining: two cotton layers and one polyester laminated in natural latex layer. Outer Cover: one PVC layer. Recommended for training on grass pitches.



### 700 126 FUTBOL Nº5 CAUCHO CELULAR GLADIATOR

Balón futbol caucho Cellular nº 5, modelo "Gladiator". Talla y peso oficial.

Football nº 5 mod. "Gladiator" Cellular rubber. Official size and weight.



### 700 125 FUTBOL Nº5 CAUCHO CELULAR TOP STAR

Balón futbol caucho Cellular nº 5, modelo, "Top Star". Talla y peso oficial. Colores: Blanco-Negro y Blanco-Rojo.

Football nº 5, mod. "Top Star" Cellular rubber. Official size and weight. Color: White/Black and White/ Red.



### 700 119 FUTBOL TECNOCAUCHO®

Ofrece unas características muy superiores al caucho normal, proporcionando al producto final una mayor elasticidad y resistencia a la abrasión.

Football Tecnocaucho®. It is much more flexible and abrasion-resistant than ordinary rubber providing a high quality end-product.



### 700 124 FUTBOL Nº TPE. SPRING

Peso: 350 gr. Ø 220 mm. Football nº 5 mod. "Spring" TPE. Weight: 350 gr. Ø 220 mm.



### 700 120 FUTBOL Nº5 CAPTAINS

Muy resistente. Válvula hinchable. Color: Rojo-Negro y Blanco-Negro. Peso: 350 gr. Ø 220 mm. Recomendado para iniciación en patio de colegio.

Football nº 5 mod. "Captains" T. P.E. Lamination in one piece. Complies with the European ToysStandard EN-71 according to: Good resistance. Inflatable valve. Color: Red/Black and White/Black. Weight: 350 gr. Ø 220 mm. Recommended for initiation on school courtyard.



700 111 FUTBOL NEON. fabricado en tecno-caucho con aditivo luminiscente que se vé en la oscuridad. Para que emita luz por la noche tiene que recibir luz durante el día para activar el aditivo luminiscente. Cuánto más tiempo reciba luz, más tiempo emite luz. Válvula hinchable. Color blanco y negro. Peso 350g, Diámetro 220mm. Recomendado para suelos abrasivos.

Made of Tecno-caucho with luminescent additive that can be seen in the dark. For emitting light at night, it has to receive light during the day to activate the luminescent additive. The longer it receives light, the longer it emits light. Inflatable valve. Black and white color. Weight: 350g Diameter: 220mm. Recommended for abrasive floors.







**700 122 FUTBOL Nº5 VULCANO**

Balón fútbol nº 5 modelo "Vulcano". Muy resistente. Válvula hinchable. Colores fluorescentes: Amarillo, rosa, azul, verde y naranja. Peso: 260 gr. Ø 220 mm. Recomendado para iniciación en patio de colegio.

*Football nº 5 mod. "Vulcano" T.P.E. Lamination in one piece. Complies with European Toys Standard EN-71. Good resistance. Inflatable valve. Fluorescent colors: Yellow, pink, blue, green and orange. Weight: 260 gr. Ø 220 mm. Recommended for initiation on school courtyard.*



**700 121 FUTBOL Nº5 ROYAL**

Balón fútbol nº 5 modelo "Royal". Muy resistente. Válvula hinchable. Color: Rojo. Peso: 260 gr. Ø 220 mm. Recomendado para iniciación en patio de colegio.

*Football nº 5 mod. "Royal" T. P.E. Lamination in one piece. Complies with the European Toys Standard EN-71. Good resistance. Inflatable valve. Color: Red. Weight: 260 gr. Ø 220 mm. Recommended for initiation on school courtyard.*

**700 226 BALON FUTBOL NEW TEAM.**

Fabricado en termoplástico. Peso 180g. Diámetro 21cm.

*Team Football. Made in Thermoplastic. Weight 180g. Diameter 21cm.*



**443 310 FUTBOL FOAM RECUBIERTO**

Balón fútbol foam recubierto Ø 170 mm. 165 gr. Football foam ball Ø 170 mm. 165 g.



**443 305 FUTBOL FOAM Ø 190 MM.**

Balón fútbol foam Ø 190 mm. Football foam ball Ø 190 mm.



**680 000** PORTERÍA DE FÚTBOL 11 DE ALUMINIO. SET de 2.

Portería de Fútbol 11 fabricada en aluminio ovalado de 140 mm. x 100mm. Refuerzos interiores que le dan gran resistencia y robustez. Unión de largueros mediante escuadras internas metálicas, que le aportan un perfecto ajuste. Sistema de enganche de red mediante piezas de ABS anti-lesión. Incluye anclajes de 50 cm. de profundidad. Medidas oficiales 7,32 m x 2,44 m. Cumple con la normativa UNE-EN 748:2004.

*FOOTBALL GOAL 11 ALUMINIUM FIXED. SET of 2.*

*Aluminium oval profile 140mm x 100 mm. Reinforced inwardly for greater resistance and robustness. Crossbars joined by internal metalique squares for a perfect fixing. Net hooked with safety system. Anchorages of 50 cm deep. Official size: 7,32 x 2,44 m. Comply with UNE-EN 748:2004*

**680 004** PORTERÍA DE FÚTBOL 7 DE ALUMINIO. SET de 2.

Portería de Fútbol 7 fabricada en aluminio ovalado de 140 mm. x 100mm. Refuerzos interiores que le dan gran resistencia y robustez. Unión de largueros mediante escuadras internas metálicas, que le aportan un perfecto ajuste. Sistema de enganche de red mediante piezas de ABS anti-lesión. Incluye anclajes de 50 cm. de profundidad. Medidas oficiales 6 m x 2 m. Cumple con la normativa UNE-EN 748:2004.

*FOOTBALL GOAL 7 ALUMINIUM FIXED. SET of 2.*

*Aluminium oval profile 140mm x 100 mm. Reinforced inwardly for greater resistance and robustness. Crossbars joined by internal metalique squares for a perfect fixing. Net hooked with safety system. Anchorages of 50 cm deep. Official sizes 6m x 2 m. Comply with UNE-ES 748:2004*



**680 003** PORTERÍA DE FÚTBOL 11 DE ALUMINIO PORTÁTIL. SET de 2.

Portería de Fútbol 11 portátil, fabricada en aluminio ovalado de 140 mm. x 100mm. Refuerzos interiores que le dan gran resistencia y robustez. Arquillos y tirantes metálicos tratados para la corrosión mediante galvanizado. Unión de largueros mediante escuadras internas metálicas, que le aportan un perfecto ajuste. Sistema de enganche de red mediante piezas de ABS anti-lesión. Profundidad de 2 m. Medidas oficiales 7,32 m x 2,44 m. Incluye anclajes antivuelco de portería portátil según normativa. Cumple con la normativa UNE-EN 748:2004.

*FOOTBALL GOAL 11 ALUMINIUM PORTABLE. SET of 2.*

*Aluminium oval profile 140 mm x 100 mm. Reinforced inwardly for greater resistance and robustness. Archs and tubes with anti-corrosion galvanized treatment. Crossbars joined by internal metalique squares for a perfect fixing. Net hooked with safety system. Anchorages of 2m deep. Official sizes 7,32 x 2,44 m. With official anti-tilt base anchoring device for transportable goal . Comply with UNE-ES 748:2004*





**680 005 PORTERÍA DE FÚTBOL 7 DE ALUMINIO PORTÁTIL. SET de 2.**

Portería de Fútbol 7 portátil, fabricada en aluminio ovalado de 140 mm. x 100mm. Refuerzos interiores que le dan gran resistencia y robustez. Arquillos y tirantes metálicos tratados para la corrosión galvanizado. Unión de largueros mediante escuadras internas metálicas, que le aportan un perfecto ajuste. Sistema de enganche de red mediante piezas de ABS anti-lesión. Profundidad de 2 m. Medidas oficiales 7,32 m x 2,44 m. Incluye anclajes anti-vuelco de portería portátil según normativa. Cumple con la normativa UNE-EN 748:2004.

**FOOTBALL GOAL 7 ALUMINIUM PORTABLE. SET of 2.**

Aluminium oval profile 140 x 100 mm. Reinforced inwardly for greater resistance and robustness. Archs and struts with anti-corrosion galvanized treatment. Crossbars joined by internal metalique squares for a perfect fixing. Net hooked with safety system. Anchorages of 2m deep.

Official sizes 7,32m x 2,44 m. With official anti-tilt base anchoring device for transportable goal.

Comply with UNE-ES 748:2004



**680 006 ARQUILLOS SUPERIORES.**

Conjunto de 2 arquillos superiores fabricados en acero, pintado con pintura de polvo epoxi secado al horno a 200°. de gran resistencia a la corrosión.

**UPPER ARCS.**

Set with 2 top archs made of steel and coated with powder epoxi painting treated to 200°C. Corrosion-resistant.



**680 008 POSTES TENSADO DE RED. SET de 2.**

Postes para el tensado de la red fabricados en tubo de acero de 45mm, pintados con pintura de polvo epoxi secado al horno a 200°. Tensado mediante carraca.

**POSTS FOR TIGHTENING THE NET. SET of 2.**

Made of round steel tube with diameter 45 mm, coated with powder epoxi painting with treatment of 200°C. Tightened by ratchet.



**680 007 BASE ABATIBLE**

Base para la sujeción de la red, plegable para permitir más fácilmente el corte del césped. Fabricada en acero pintado con pintura de polvo epoxi secado al horno a 200°. Por unidad de portería.

**FOLDING BASE**

Base for fixing the net. Can be folded for cutting the grass easily. Made of steel coated with powder epoxi painting treated to 200° C. Corrosion-resistant.



Enganche de sujeción al suelo para porterías portátiles.  
Hook for fix theportable goals to the ground.



**690 001 RED DE FÚTBOL 11.**Juego. Fabricadas en PE sin nudos. 4 mm. Blanca.

**690 007 RED DE FÚTBOL 7 .** Juego. Fabricadas en PE sin nudos. 3 mm. Blanca



Detalle del enganche para la red.  
Detail of the net hook.

Porterías desmontables, ligeras y resistentes, fabricadas en tubo nervado de PVC. Incluye red especial. Para fútbol, fútbol sala y balonmano.  
Sectional goals, light and resistant, made in nerved PVC tube. Special net included. For football, indoor football and handball.

**610 095** Portería 300 x 200 x 90 cm. - Goal 300 x 200 x 90 cm.

**610 096** Portería 300 x 150 x 80 cm. - Goal 300 x 150 x 80 cm.

**610 097** Portería 200 x 150 x 80 cm. - Goal 200 x 150 x 80 cm.

**610 098** Portería 200 x 100 x 60 cm. - Goal 200 x 100 x 60 cm.

**610 099** Portería 150 x 100 x 60 cm. - Goal 150 x 100 x 60 cm.

**610 105** Portería 100x75x50mm. Recomendada para ejercitar la puntería en los entrenamientos de fútbol. - Foot goal 100x75x50mm. Recommended to exercise aim in soccer training.

**610 161** - Portería con escuadra 300 x 200 x 90 cm. - Foot goal 300 x 200 x 90 cm.

**610 162** - Portería con escuadra 300 x 150 x 80 cm. - Foot goal 300 x 150 x 80 cm.

**610 163** - Portería con escuadra 200 x 150 x 80 cm. - Foot goal 200 x 150 x 80 cm.

**610 164** - Portería con escuadra 200 x 100 x 60 cm. - Foot goal 200 x 100 x 60 cm.

**610 165** - Portería con escuadra 150 x 100 x 60 cm. - Foot goal 150 x 100 x 60 cm.

**610 166** - Portería 100x75x50mm con escuadra. Recomendada para ejercitar la puntería en los entrenamientos de fútbol- Foot goal with square 100x75x50mm. Recommended to exercise aim in soccer training.



**610 101** Portería fútbol, 140 x 105 x 72 cm. - Foot goal 140 x 105 x 72 cm.

**610 102** Portería fútbol, 100 x 80 x 60 cm. - Foot goal 100 x 80 x 60 cm.

**610 103** Portería fútbol, 90 x 60 x 42 cm. - Foot goal 90 x 60 x 42 cm.



**610 104** Portería fútbol, 60 x 45 x 30 cm. Set de 2 porterías.  
Foot goal 60 x 45 x 30 cm. Set of 2 goals.

## ACCESORIOS ENTRENAMIENTO - TRAINING ACCESOIRES

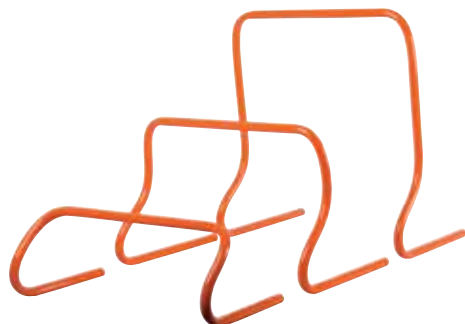

**642 000** Vallas de entrenamiento mini 15 cm. - Training mini-hurdles 15 cm.

**642 005** Vallas de entrenamiento mini 30 cm. - Training mini-hurdles 30 cm.

**642 010** Vallas de entrenamiento mini 50 cm. - Training mini-hurdles 50 cm.

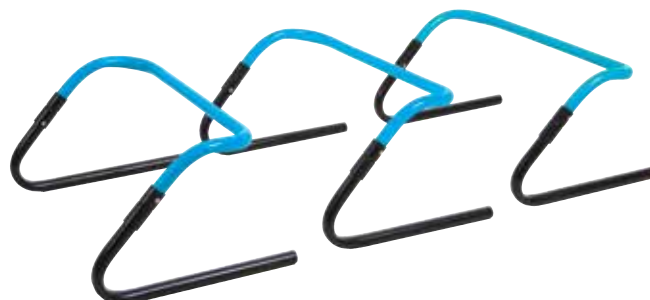

**642011** Vallas de salto entrenamiento funcional doble altura.  
Vallas funcionales de doble altura. Altura de 20 y 30 cm. Ancho 46 cm.  
Training hurdles double high. Height from 20 to 30 cm. Width 46 cm.



ACCESORIOS ENTRENAMIENTO - TRAINING ACCESOIRES



**64203600 ESCALERA DE AGILIDAD DIVISIBLE 2 X 2 M.**

Escalera de agilidad para ejercicios de coordinación, velocidad y agilidad. Compuestas por dos partes de 2 metros que se pueden separar para crear dos carriles paralelos.

**AGILITY LADDER SEPARABLE 2 X 2 M.**

Composed of two parts of 2 metres each one, that can be separated to make two parallel lanes.



**642 035** Escalera de agilidad. Longitud 4 m.  
Agility stairs. 4 m. lenght.

**64203700 ESCALERA DE AGILIDAD PLANA**

Escalera de agilidad plana. Largo 4 m. Ancho 50 cm. Grosor 6 mm. Fabricada en caucho antideslizante.

**AGILITY PLAIN STAIRS**

Agility plain stairs. Length 4m width 50 cm height 6mm. Made of non-slip rubber.



**642 030** Paracaídas potenciador de la velocidad.  
*Speed power parachute.*



**642 017** Arcos de entrenamiento y disparo. Dimensiones: 35 x 35 cm.  
*Shooting arcs. Dimensions: 35 x 35 cm.*

**642 018** Arcos de entrenamiento y disparo. Dimensiones: 40 x 40 cm.  
*Shooting arcs. Dimensions: 40 x 40 cm.*

**642 019** Arcos de entrenamiento y disparo. Dimensiones: 45 x 45 cm.  
*Shooting arcs. Dimensions: 45 x 45 cm.*



**642 045** Set de obstáculos jump. Compuesto por 2 conos, 2 soportes y una pica.  
*Set obstacles jump. Composed by 2 cones, 2 supports and a stick.*

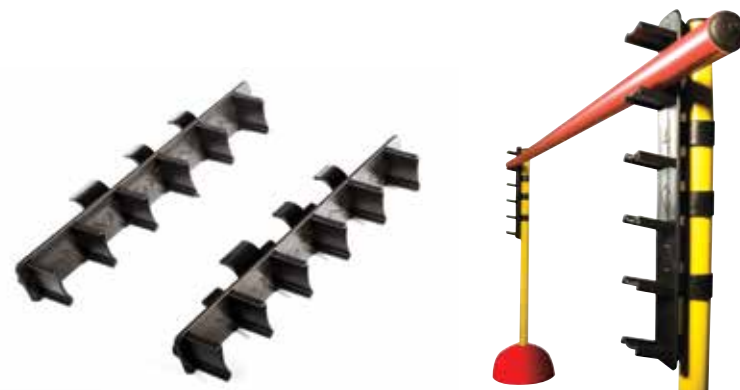

**642 050** Pieza regulable en altura para pica. 6 niveles.  
*Piece for sticks high adjustable. 6 levels.*



**642 040** Trineo potenciador de la velocidad. - *Speed power sleigh.*





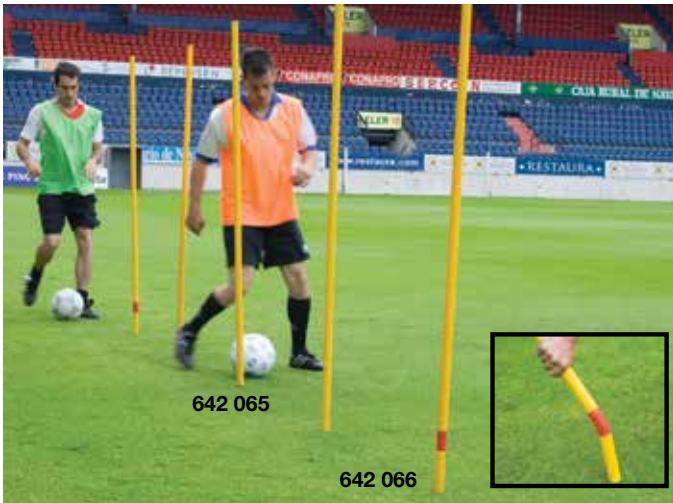

642 065

642 066

**642 065** Picas para slalom fijas para clavar en el suelo.  
Slalom poles to fix in the ground. 170 cm.

**642 066** Picas para slalom fijas flexibles para clavar en el suelo.  
Flexible slalom poles to fix in the ground. 170 cm.



**642 060** Bolso para picas de slalom. Capacidad de 20 unidades.  
Slalom pole bag. Capacity 20 units.



**642 062** Base para picas de slalom. - Slalom pole base.



**432 508 BASE PARA PICA DE 25 mm.**

Base fabricada en caucho. Diámetro del agujero: 25 mm. Diámetro base: 225 mm. Peso: 1.5 kg.

Base made of rubber. Hole Diameter: 25 mm

Base Diameter: 22.5 cm. Weight: 1,5 kg.



642 075

**642 070** Siluetas para entrenamiento de tiro de falta. Fácil de clavar en el suelo. 180 cm de altura. - Free kick wall. 180 cm high.

**642 075** Carro para transportar 5 siluetas de entrenamiento. - Trolley for 5 free kick walls.



**642 071 SILUETAS FLEXIBLES**

Estructura fabricada en acero galvanizado y pintado. Interior de poliéster. Tienen muelle en la base para volver a la posición original. Altura 180 cm.

**FLEXIBLE FOOTBALL TRAINING MANNEQUINS**

Structure made of galvanised painted steel with the filling made of polyester. It has springs on the base to quickly return to its original position. Height: 180 cm.



**642 074 BASE PARA SILUETAS INDIVIDUAL**

Estructura fabricada en acero galvanizado y pintado. Con ruedas para transportar. Adecuada para campos de hierba artificial. Peso: 5 Kg.

**BASE FOR TRAINING MANNEQUINS**

Structure made of galvanised painted steel. The base has wheels to be transported. Suitable for artificial pitches. Weight: 5 Kg.



**642 055** Cono flexible para picas. Set de 8 unidades. Tamaño: Ø 30 x 15 cm.  
Flexible cone for sticks. Set 8 units. Size: Ø 30 x 15 cm.



**432 500** Cono de 24 cm. - Cone 24 cm.



**432 501** Cono señalización en PE de 32 cm.  
Cones 32 cm.

Cono de 42 y de 52 cm. fabricado en P.E. nuevo y flexible. Recupera su forma tras la deformación.  
Cone 42 and 52cm made in flexible P.E. Recover its shape after deformation.

**432 493** Cono 42 cm. Base: 28 x 28 cm. Diámetro 18 cm. Peso : 390 gr. - Cone 42 cm.

**432 496** Cono 52 cm. Base: 28 x 28 cm. Diámetro 18 cm. Peso : 463 gr. - Cone 52 cm.



FÚTBOL - FOOTBALL



**410 900** Engarce fijo de picas.  
Bolsa de 12 unidades.  
Linking for sticks. Bag with 12 u.



**410 901** Engarce universal.  
Bolsa de 6 unidades.  
Multi-linking. Bag with 6 u.



**432 506** Soporte para conos y picas.  
Support for cone and stick.



**432 502** Cono redondo, set de 40 unidades.  
Round cone. Set 40 units.



**432 505** Cono gran flexibilidad,  
set de 48 unidades.  
Flexible cone. Set 48 units.



**432 504** Base maciza de 1,8 kg.  
para kit de entrenamiento.  
Solid base 1,8 kg. for training kit



**900 878** Banderines corner flexibles. - Flexible corner flags.





**900 850** Peto de rejilla reversible. Tamaño niño. - *Training reversible vest. Children size.*  
**900 851** Peto de rejilla reversible. Tamaño joven. - *Training reversible vest. Young size.*  
**900 852** Peto de rejilla reversible. Tamaño adulto. - *Training reversible vest. Adult size.*  
 Colores: naranja-amarillo, azul-verde. - *Colours: orange-yellow, blue-green.*



**900 856** Peto tirantes niño. Fabricado en polyester Un color. Cerrado sin gomas. Ancho 46 cm. Largo 55 cm. Set 5 ud.  
**900 857** Peto tirantes joven. Fabricado en polyester Un color. Cerrado sin gomas. Ancho 56 cm. Largo 62 cm. Set 5 ud.  
**900 858** Peto tirantes adulto. Fabricado en polyester Un color. Cerrado sin gomas. Ancho 60 cm. Largo 70 cm. Set 5 ud.  
 Colores: rojo, verde, naranja y azul.



**900 855** Peto de rejilla. - *Net vest.*



**900 854** Peto abierto con elástico talla XL. Medidas: 48 x 31 cm. Set 5 ud.



**642 096** BOTELLA AGUA ENTRENAMIENTO  
 750 ml. *Water Bottle 750 ml.*

**642 095** PORTA BOTELLAS DE AGUA PARA 6 U.  
 Fabricada en polietileno. Plegable. Asa atornillada. Imposible soltarse.  
*Water Bottle Carrier (hold up to 6 bottles), Plastic.*



**900 876** Brazalete de capitán. - *Captain's bracelet.*



**642 100** Pancarta de sustitución. - *Substitution card.*



**900 874** Set de árbitro. - *Referee set*



**900 877** Banderines linier pro. Set de 2 unidades. - *Linier pro flags. Set of 2 units.*





**690 100 GUANTES WARRIOR. TALLA 4, 6 Y 8. Cuero sintético.**

Palma de foam anti deslizante de grosor 3 mm. Dorso de Gussetts Speedo tejido de alta resistencia. Muñeca con banda elástica de foam de 4 x 10 cm. Tallas XXS, XS y S.

Size 4, 6, 8 Palm 3 mm .High Grip Foam. Backhand 1 Hi-Foam. FLAT CUT Backhand 2 High strength Speedo Fabric. Intermediate Wrist 1 4 cm. Elasticated Wrist Band. Wrist 2 4 cm. Wide & 10 cm. Long Hi-Foam Strap.

**690 110 GUANTES EVOLUTION. PROFESIONAL. JOVEN Y ADULTO. TALLA 9 Y 10**

Palma de foam anti deslizante 6 mm. Dorso de foam antideslizante de 3 mm. Interior con revés cerrado con laminación de espuma de 8 mm. Muñeca con banda elástica de foam con fijación doble y toalla de soporte. Longitud banda 6 x 24 cm. Tallas M y L.

Size 9 and 10. Palm High grip imported Latex Foam 3+3mm - White  
Backhand 1 Hi-Foam 3 mm.  
FLAT CUT Backhand 2 Closed Mesh With 8mm PC Foam Lamination  
Professional Wrist 1 8 cm. Elasticated Wrist Band With Towel Backing & Double Fastening. Wrist 2 6 cm. Z Wide & 24cm Long Hi-Foam Strap.

**690 120 GUANTES GLADIATOR. PROFESIONAL CALIDAD FIFA. TALLAS ADULTO. TALLA 10 Y 11**

Palma de foam anti deslizante de 6 mm. Dorso de German foam antideslizante de 8mm

Interior con revés cerrado con laminación de espuma de 8 mm. Muñeca con banda elástica de foam con fijación doble y toalla de soporte. Longitud banda 5 x 24 cm. Tallas L y XL.

Palm High grip imported Latex Foam 3+3mm - White. Backhand 1 4+4 mm Latico New Basic Latex Foam (German). ROLL CUT Backhand 2 Closed Mesh With 8mm PC Foam Lamination. Professional Wrist 1 8cm Elasticated Wrist Band With Towel Backing & Double Fastening. Wrist 2 5 cm Wide & 24cm Long Hi-Foam Strap



**690 140 Espinillera funcional. Lámina de EVA foamada recubierta de concha de plástico. Parte más externa Poliuretano. Sujeciones en tela acrílica transpirable. Se pueden desmontar las sujecciones de tela superior e inferior para lavar.\* TALLAS: S, M, L.**

**SHIN GUARDS**

Foamed EVA pad and Shell covered. Outer layer made of polyurethane. Washable and breathable guard. Sizes: S, M, L.



**690 130 Espinillera profesional. Lámina de EVA foamizada recubierta de concha de plástico. Sistema de amortiguación de golpes. Incluye media sin pie de licra de máxima calidad y transpiración. Talla única. Colores: negro, rojo, amarillo fluor, verde fluor, rosa fluor, naranja fluor.**

**PRO SHIN GUARDS**

Professional Shin guard. Foamed EVA pad and Shell covered. Cushioning system. Breathable tight made of high quality lycra. One size. Colours: black, red, fluorescent yellow, fluorescent green, fluorescent pink, fluorescent orange.





900 961



900 960

**900 960 CRONÓMETRO S06**

Funciones:

- Hora normal y hora dual
- Despertador
- Cronómetro

Fabricado con materiales plásticos anti-rotura. Con cordón para colgar.

**900 961** Cronómetro 30 lap. Hora dual, calendario, cuenta a trás, 30 registros, alarma, función metrónomo hasta 10 velocidades.

*Lap stopwatch. Dual, calendar, countdown, 30 register, alarm, metronome until 10 speed.*



**900 989** Contador pulsaciones calorías, etc  
*Pulse computer, calories counter, etc.*



**642 090** Medidor de presión para balones.  
*Deluxe Press Gauge.*



**900913** Silbato plástico. - *Plastic whistle.*



**900910** Silbato metálico  
*Metal whistle.*



**900912** Silbato plástico en blister con cordón.  
*Plastic whistle in blister with rope.*



**900 915** Red para ocho balones. - *Net for 8 balls.*



**900 916** Red individual balones. - *Net for 1 ball.*



**900911** Silbato metálico en blister con cordón.  
*Metal whistle in blister with rope.*



**642 080** Bolso guardabalones. Capacidad para 16 balones hinchados.  
*Ball sacks 16 pcs.*



**900 935** Pizarra táctica grande de aluminio 60 x 90 cm. Basket. - *Big aluminium tactic blackboard. 60 x 90 cm. Basketball.*

**900 936** Pizarra táctica grande de aluminio 60 x 90 cm. Fútbol. - *Big aluminium tactic blackboard. 60 x 90 cm. Football.*

**900 937** Pizarra táctica grande de aluminio 60 x 90 cm. Balonmano. - *Big aluminium tactic blackboard. 60 x 90 cm. Handball.*

**900 938** Pizarra táctica grande de aluminio 60 x 90 cm. Volley. - *Big aluminium tactic blackboard. 60 x 90 cm. Volleyball.*

**900 940** Pizarra táctica mediana aluminio 45 x 60 cm. Basket. - *Medium aluminium tactic blackboard. 45 x 60 cm. Basketball.*

**900 941** Pizarra táctica mediana aluminio 45 x 60 cm. Fútbol. - *Medium aluminium tactic blackboard. 45 x 60 cm. Football.*

**900 942** Pizarra táctica mediana aluminio 45 x 60 cm. Balonmano. - *Medium aluminium tactic blackboard. 45 x 60 cm. Handball.*

**900 943** Pizarra táctica mediana aluminio 45 x 60 cm. Volley. - *Medium aluminium tactic blackboard. 45 x 60 cm. Volleyball.*

**900 945** Pizarra táctica pequeña aluminio 30 x 45 cm. Basket. - *Small aluminium tactic blackboard. 30 x 45 cm. Basketball.*

**900 946** Pizarra táctica pequeña aluminio 30 x 45 cm. Fútbol. - *Small aluminium tactic blackboard. 30 x 45 cm. Football.*

**900 947** Pizarra táctica pequeña aluminio 30 x 45 cm. Balonmano. - *Small aluminium tactic blackboard. 30 x 45 cm. Handball.*

**900 948** Pizarra táctica pequeña aluminio 30 x 45 cm. Volley. - *Small aluminium tactic blackboard. 30 x 45 cm. Volleyball.*



**900 950** Carpeta táctica basket. Dos caras.

**900 952** Carpeta táctica fútbol. Dos caras.

**900 954** Carpeta táctica balonmano. Dos caras.

**900 956** Carpeta táctica voley. Dos caras.



### 700 141 Futbol sala modelo THERMOLINK 62 cm.

Balón fútbol sala unión THERMOLINK. Nuevo sistema de unión más duradero. Superficie antideslizante. Sistema especial para retención del aire. Sistema anti vibración.

Nueva tecnología 62cm. 4 capas. Capa más externa TPU. Cámara y válvula de butylo de alta calidad. Control system. Fabricado acorde a la normativa de la federación española. Peso: 420-440 gr.

*Indoor Football ball THERMOLINK 62 cm.*

*New fix system more durable. Non flip surface. Special system for air retention. No-vibration system. New technology 62 cm. 4 layers. TPU extern layer. Bladder and valve high quality butyl. Control System. Manufactured to comply with the regulation of the Spanish Federation.*

*Weight: 420- 440 gr. Circumference: 62 cm.*

### 700 142 Futbol sala modelo THERMOLINK 58 cm.

Balón fútbol sala unión THERMOLINK. Nuevo sistema de unión más duradero. Superficie antideslizante. Sistema especial para retención del aire. Sistema anti vibración.

Nueva tecnología 58cm. 4 capas. Capa más externa TPU. Cámara y válvula de butylo de alta calidad. Control system. Fabricado acorde a la normativa de la federación española. Peso: 380-400 gr.

*Indoor Football ball THERMOLINK 58 cm.*

*New fix system more durable. Non flip surface. Special system for air retention. No-vibration system. New technology 58 cm. 4 layers. TPU extern layer. Bladder and valve high quality butyl. Control System. Manufactured to comply with the regulation of the Spanish Federation.*

*Weight: 380- 400 gr. Circumference: 58 cm.*

## NOVEDADES TECNOLÓGICAS - TECHNOLOGIC NEWS



### 700 129 BALÓN FUTBOL SALA KIENYKE 62 cm.

Fabricado en cuero sintético 4 capas, capa externa TPU. Cámara y válvula de butylo de alta calidad. Nuevo núcleo interno para mayor equilibrio y control. Sistema interno anti-vibración. Fabricado acorde a la normativa de la federación española. Válvula hinchable de butilo. Peso: 440 gr. Circunferencia: 62 cm.

*FOOTBALL BALL KIENYKE 62 CM*

*Made of synthetic leather with four layers and outer cover of TPU. Internal core providing a better control and balance. Inner system vibration-isolated. Bladder and valve: high quality butyl. Manufactured to comply with the regulation of the Spanish Federation. Weight: 440 gr. Circumference: 62 cm.*



### 700 130 BALÓN FOOTBALL SALA KIENYKE 58 cm.

Fabricado en cuero sintético 4 capas, capa externa TPU. Cámara y válvula de butylo de alta calidad. Nuevo núcleo interno para mayor equilibrio y control. Sistema interno anti-vibración. Fabricado acorde a la normativa de la federación española. Peso: 380 gr. Circunferencia: 58 cm.

*FOOTBALL BALL KIENYKE 58 CM*

*Made of synthetic leather with four layers and outer cover of TPU. Internal core providing a better control and balance. Inner system vibration-isolated. Bladder and valve: high quality butyl. Manufactured to comply with the regulation of the Spanish Federation. Weight: 380 gr. Circumference: 58 cm.*



### 700 140 TERMOSOLDADO 62 cm.

Nuevo balón fútbol sala soft Senior 62 cm. cuero termosoldado. 420 gr.

*New Indoor football Senior 62 cm. thermowelded leather.*





**700 131 BALÓN PU CUERO COSIDO SOFT N.4.**

Senior 62 cm. 420 gr. - PU leather soft Indoor football Senior 62 cm. Ø 200- 205 mm. 420 gr.

**700 133 BALÓN PU CUERO COSIDO SOFT N.3**

Balón PU cuero cosido soft Junior 58 cm. Ø 180-185 mm. 400 gr. - PU leather soft Indoor football Junior 58 cm. Ø 180-185 mm. 434 gr.



**700 139 BALÓN FÚTBOL SALA SOFT TOUCH 58 cm.**

Balón fútbol sala Cuero "soft touch" 58 cm. Foam antilesión debajo de la capa externa. Foam en el interior para conseguir el bote oficial. Ø 185 mm. Peso 400 gr.

Indoor football leather "Soft touch" 58 cm. Anti-lesion foam under the outer ply. Foam inside for getting the official weight. Ø 200 mm. 420 gr. Ø 185 mm. 400 gr.



**700 135** Balón fútbol sala Senior caucho. 62 cm. Peso: 450 gr. - Indoor football Senior rubber. 62 cm.- 450 gr.



**700 134** Balón futbol sala Cellular 58 cm. 440 gr. Indoor football 58 cm. Cellular. 440 gr.

**465 900** Pelota sonora de caucho celular fútbol sala. Ø180 mm. Sonorous cellular rubber ball indoor soccer. Ø180 mm.

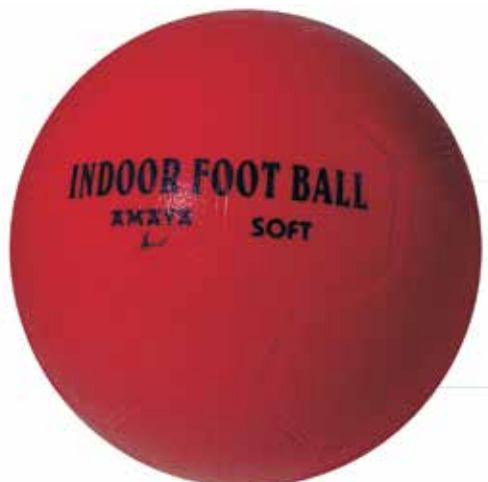

**700 137** Balón fútbol sala Junior Soft TPE. Peso: 250 gr. Ø 190 mm.

Indoor football Junior Soft TPE. Weight: 250 gr. Ø 190 mm.

## NOVEDADES TECNOLÓGICAS - TECHNOLOGIC NEWS



Antideslizante. Cámara y válvula de butilo de alta calidad. Apto para competición.

Laminación interna: cuatro capas de cuero sintético. Capa externa: cubierta de cuero no resbaladizo. Efecto amortiguación al impacto. Vejiga: butilo de máxima calidad.

Válvula: butilo con efecto anti-bloqueo de salida de aire.

*Non-slipping surface. Suitable for competition. Inner lining: four sythetic layers.*

*Outer cover: non-slipping leather and padding effect. Bladder and valve: High quality butyl and air holding system.*

### 700 146 BALÓN DE BALONMANO MICRON Nº3

Peso – 429 gr. Diámetro:18.5 -19 cm. Excelente agarre. Apto para todos los campos. Cumple normativa EN-71. - *Weight: 429 gr. Diameter: 18.5-19 cm*

*Excellent gripping, suitable for all grounds and complies with EN-71 regulations.*

### 700 145 BALÓN DE BALONMANO MICRON Nº2

Peso – 325-375 gr. Diámetro: 17 - 17,5 cm. Perímetro: 54-56 cm. Excelente agarre. Apto para todos los campos. Cumple normativa EN-71.

- *Weight: 325-375 gr. Diameter: 17-17.5 cm. Excellent gripping, suitable for all grounds and complies with EN-71 regulations.*



Balón balonmano "Soft touch" foam antilesión debajo de la capa más externa. Superficie antideslizante.

*Handball "Soft touch" anti-lesion foam under the outer ply. Grippy surface.*

**700 147** Balón balonmano nº 00 "Soft touch". Especial para iniciación en colegio. - *Handball N. 00 "Soft touch". Special for school initiation.*

**700 148** Balón balonmano nº 0 "Soft touch". Especial para categoría benjamín. - *Handball N. 0 "Soft touch".*

**700 149** Balón balonmano nº 1 "Soft touch". Especial para categoría alevín. - *Handball N. 1 "Soft touch".*

**700 150** Balón balonmano nº 2 "Soft touch". Especial para categoría infantil.- *Handball N. 2 "Soft touch".*

**700 151** Balón balonmano nº 3 "Soft touch". Especial para categoría juvenil.- *Handball N. 3 "Soft touch".*





- 700 345 Balonmano 00 Tecno Caucho® - Handball 00 Tecno Caucho®
- 700 346 Balonmano 0 Tecno Caucho® - Handball 0 Tecno Caucho®
- 700 347 Balonmano 1 Tecno Caucho® - Handball 1 Tecno Caucho®
- 700 348 Balonmano 2 Tecno Caucho® - Handball 2 Tecno Caucho®



- 700 340 Balón balonmano N.00 Iniciación. Soft TPE. Peso: 225 gr. Ø 140 mm. - Handball N.00 Soft TPE. Weight: 225 gr. Ø 140 mm.
- 700 341 Balón balonmano N.0 Benamín. Soft TPE. Peso: 270 gr. Ø 150 mm. - Handball N.0 Soft TPE. Weight: 270 gr. Ø 150 mm.
- 700 342 Balón balonmano N.1 Alevín. Soft TPE. Peso: 300 gr. Ø 160 mm. - Handball N.1 Soft TPE. Weight: 300 gr. Ø 160 mm.
- 700 343 Balón balonmano N.2 Infantil. Soft TPE. Peso: 330 gr. Ø 175 mm. - Handball N.2 Soft TPE. Weight: 330 gr. Ø 175 mm.



- 465 700 Pelota sonora de caucho celular balonmano. Ø150 mm.  
Sonorous cellular rubber ball handball. Ø150 mm.



- 700 152 Balón balonmano caucho Cellular nº 0. Talla y peso oficial. - Handball nº 0 Cellular rubber. Official size and weight.
- 700 153 Balón balonmano caucho Cellular nº 1. Talla y peso oficial. - Handball nº 1 Cellular rubber. Official size and weight.



- 700 159 Balón balonmano N.1 alevín caucho. - Handball N. 1 rubber.



- 443 510 Balón balonmano N.0 foam Ø 150 mm. Colores surtidos.  
Handball foam N.0 Ø 150 mm. Assorted colors.



## 680 100 PORTERÍA DE BALONMANO COMPETICIÓN DE ALUMINIO. Arquillo ovalado (SET DE 2 UNIDADES)

Juego de porterías de Balonmano fabricadas en aluminio de 80mm x 80 mm con cantos redondeados. Aluminio reforzado interiormente para mayor resistencia y robustez. Unión de largueros mediante escuadras internas metálicas, que le aportan un perfecto ajuste. Sistema de enganche de red mediante piezas de ABS anti-lesión. Base inferior ovalada para mayor superficie de apoyo. Sistema anti-vuelco, mediante la sujeción al suelo por la parte posterior mediante tornillos de seguridad. Acorde con la normativa UNE-EN 749.

### HANDBALL GOALS . COMPETITION. ALUMINIUM OVAL ARCH.(SET 2)

Aluminium rounded edges profile 80mmx 80mm . Reinforced inwardly for greater resistance and robustness. Crossbars joined by internal metalique squares for a perfect fixing. Net hooked with safety system. Oval lower base for greater support. Include anti-tilt base anchoring device with safety screws. Comply with UNE-EN 749



690 002 REDES BALONMANO Y FÚTBOL SALA.

## 680 101 PORTERÍA DE BALONMANO FIJA DE ALUMINIO. Arquillo cuadrado (SET DE 2 UNIDADES)

Juego de porterías de Balonmano fabricadas en aluminio de 80mm x 80 mm con cantos redondeados. Aluminio reforzado interiormente para mayor resistencia y robustez. Unión de largueros mediante escuadras internas metálicas, que le aportan un perfecto ajuste. Sistema de enganche de red mediante piezas de ABS anti-lesión. Base inferior Cuadrada. Sistema anti-vuelco, mediante la sujeción al suelo por la parte posterior mediante tornillos de seguridad. Acorde con la normativa UNE-EN 749.

### HANDBALL GOALS . FIXED. ALUMINIUM SQUARE ARCH.(SET 2)

Aluminium rounded edges profile 80mmx 80mm. Reinforced inwardly for greater resistance and robustness. Crossbars joined by internal metalique squares for a perfect fixing. Net hooked with safety system ABS pieces. Square lower base. Include Anti-tilt base anchoring device with safety screws. Comply with UNE-EN 749



**NOVEDADES TECNOLÓGICAS - TECHNOLOGIC NEWS**

**BASKET BICOLOR CAUCHO CELLULAR PLUS**

Fabricados en caucho reforzado con fibra japonesa englobando células de aire en su interior. MÁXIMO EFECTO CELLULAR. Talla y peso oficial Resistencia 5 veces mayor que el balón de caucho clásico. Superficie exterior rugosa. Fabricado en materiales aprobados por la En-71.

*Made of reinforced rubber with japanese fiber grouping air cells inside and providing the highest celular effect. Official weight and size. Wrinkled surface and five times more resistant that classic rubber balls. Manufactured with materials complying with EN71 regulations.*



**700 220 BASKET BICOLOR VERDE N° 7**  
Peso: 580-600 gr. Diámetro: 238 mm.



**700 221 BASKET BICOLOR MAGENTA N° 6**  
510-557 grs. Diámetro: 224-235 mm.

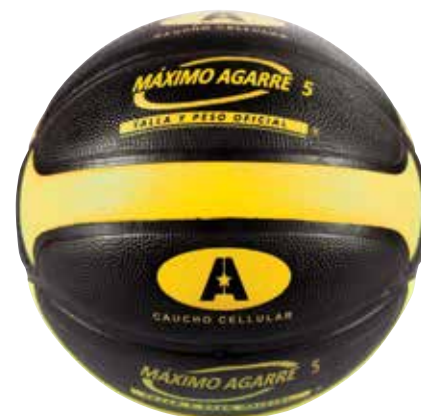

**700 222 BASKET BICOLOR AMARILLO N° 5**  
Peso: 470-510 gr. Diámetro: 219 mm.



**CAUCHO CELULAR PLUS**

**700 217** Balón basket caucho Cellular n° 7, color naranja. Peso: 600 gr.  
*Basket ball n° 7, orange color Cellular rubber. 600 gr.*

**700 219** Balón basket caucho Cellular n° 6, color naranja. Peso: 550 gr.  
*Basket ball n° 6, orange color Cellular rubber. 550 gr.*

**700 218** Balón basket caucho Cellular n° 5, color naranja. Peso: 500 gr.  
*Basket ball n° 5, orange color Cellular rubber. 500 gr.*



**CAUCHO CELULAR PLUS**

**465 800** Balón n° 7 sonoro de caucho celular basket. Ø 240 mm.  
Peso: 650 gr.

*Sonorous Basket ball n° 7, orange color Cellular rubber Ø 240 mm. 650 gr.*



**700 200** Balón basket nº 7 fabricado en cuero sintético termosoldado de alta calidad. Vejiga de itrel. Superficie rugosa de excelente agarre. Talla y peso oficial. Excelentes prestaciones. Recomendado para competición. 625 gr.

*Basketball N. 7 made of syntetic leather. 625 gr.*



**700 215** Balón basket caucho Cellular nº 7 bicolor. Peso: 610 gr.  
*Basket ball nº 7 bicolor Cellular rubber. Weight: 610 gr.*

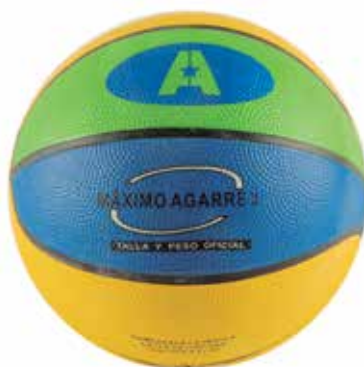

**700 209** Balón mini-basket nº 3 caucho tricolor. Peso: 310 g.  
*Basketball nº 3 three-colored rubber. 310 g.*



**700 202** Balón basket nº 7 bicolor caucho. Lámina de caucho en una única pieza. Vejiga de butilo y poliéster. Superficie rugosa de gran agarre. Peso y talla oficial. Recomendado para iniciación y entrenamiento. 605 gr.  
*Basketball nº 7 two-colored rubber. Rubber lamination in one piece. Bladder: Butyl and polyester. Surface: Rugged. Recommended for initiation and training. 605 gr.*

**700 203** Balón basket nº 5 bicolor caucho. - *Basketball nº 5 two-colored rubber.*

**700 204** Balón basket nº 6 bicolor caucho. - *Basketball nº 6 two-colored rubber.*



**700 205** Balón basket nº 7 caucho. Lámina de caucho en una única pieza. Vejiga de butilo y poliéster. Superficie rugosa de gran agarre. Talla y peso oficial. Recomendado para iniciación y entrenamiento. 605 gr.  
*Basketball nº 7 orange rubber. Rubber lamination in one piece. 605 gr.*

**700 212** Balón basket nº 6 caucho. Lámina de caucho en una única pieza. Vejiga de butilo y poliéster. Superficie rugosa de gran agarre. Talla y peso oficial. Recomendado para iniciación y entrenamiento. 605 g.  
*Basketball nº 6 orange rubber. Rubber lamination in one piece.*





**Tecnocaucho®**

Ofrece unas características muy superiores al caucho normal, proporcionando al producto final una mayor elasticidad y resistencia a la abrasión. *Tecnocaucho®. It is much more flexible and abrasion-resistant than ordinary rubber providing a high quality end-product.*

**700 195** Basketball 7 Tecnocaucho®

**700 196** Basketball 6 Tecnocaucho®

**700 197** Basketball 5 Tecnocaucho®



**700 210** Balón nº 7 P.V.C. Fabricado en una única pieza. Peso: 355 gr.  
*Basket ball nº 7 . Lamination in one piece. Weight: 355 gr.*

**700 211** Balón mini-basket nº 5 P.V.C. Peso: 310 gr.  
*Basket ball nº 5 PVC. Weight: 310 gr.*



**700 213** Balón basket Nº 5 soft TPE. Peso: 320 gr.  
*Basket ball Nº 5 TPE. Weight: 320 gr.*

**700 214** Balón basket Nº 7 soft TPE. Peso: 352 gr.  
*Basket ball Nº 7 TPE. Weight: 352 gr.*



**443 405** Balón basket soft foam Ø 190 mm. 305 gr.  
*Basketball soft foam Ø 190 mm. 305 gr.*



Enganche de sujeción al suelo.  
Hook to fix in the ground.

### JUEGO DE CANASTAS FIJAS DE BASKET.

Juego de canastas fijas de Basket . Fabricadas en tubo de acero de 100mm. x 80 mm. pintados con pintura de polvo epoxi secado al horno a 200°. Anclajes al suelo mediante varillas roscadas unidas entre si para insertar en el cubo de hormigón. Canastas con vuelo de 1,65 m . Acorde a la normativa UNE-EN 1270.

#### BASKETBALL SET SYSTEM. FIXED.

*Basketball set made of steel tube 100 x 80 mm coated with powder epoxi painting with treatment 200°C. Anchoring official system. Clearance space: 1,65 m. Comply with UNE-EN 1270*

### 680 650 Juego de canastas basket con tableros de fibra, aros basculantes y redes.

*Basketball set with fiber backboards, hoop and nets.*

### 680 652 Juego de canastas basket con tableros de cristal templado, aros basculantes y redes.

*Basketball set with tempered glass backboards, hoop and nets.*

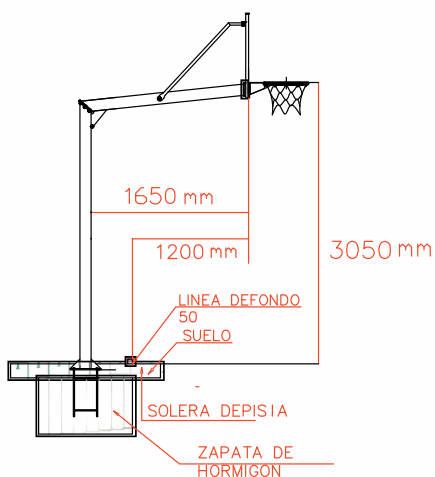

### JUEGO DE CANASTAS FIJAS DE MINI-BASKET.

Juego de canastas fijas de Minibasket . Fabricadas en tubo de acero de 100mm. x 80 mm. pintados con pintura de polvo epoxi secado al horno a 200°. Anclajes al suelo mediante varillas roscadas unidas entre si para insertar en el cubo de hormigón. Canastas con vuelo de 1 m . Acorde a la normativa UNE-EN 1270.

#### MINIBASKETBALL SYSTEM. FIXED.

*Steel tube 100 x 80 mm coated with powder epoxi painting with treatment 200°C. Anchoring official system. Clearance space: 1,65 m Comply with UNE-EN 1270.*

### 680 662 Juego de canastas mini-basket con tableros de fibra, aros basculantes y redes.

*Minibasketball set with fiber backboards, hoop and nets.*

### 680 664 Juego de canastas mini-basket con tableros de cristal templado, aros basculantes y redes.

*Minibasketball set with tempered glass backboards, hoop and nets.*

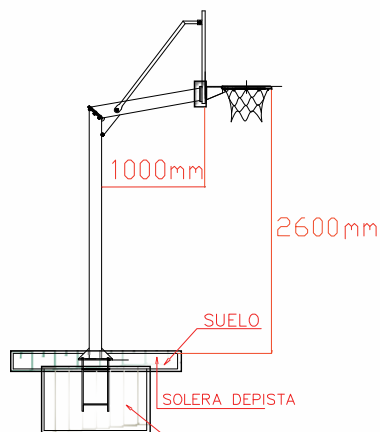



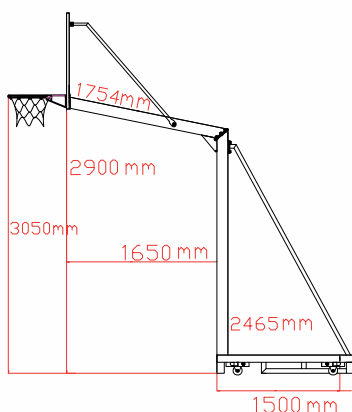
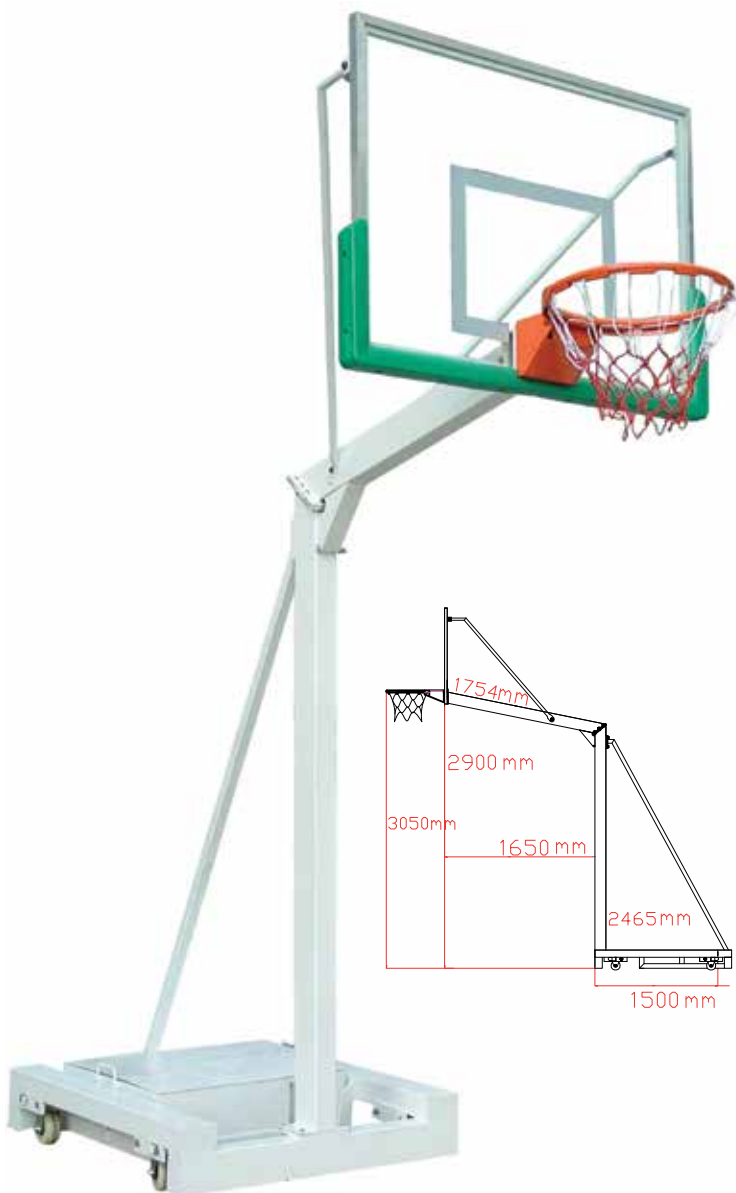

#### CANASTAS TRASLADABLES DE BASKET.

Juego de canastas trasladables de Basket . Fabricadas en tubo de acero de 100 mm. x 80 mm. pintados con pintura de polvo epoxi secado al horno a 200°. Base fabricada en tubo de acero, con cavidad para poner contrapesos o cajón metálico para hormigón. Sistema de 4 ruedas para su portabilidad, fácil transporte. Canastas con vuelo de 1,65 m . Sistema anti-vuelco de anclaje al suelo mediante tornillos de seguridad. Acorde a la normativa UNE-EN 1270.

#### BASKETBALL SYSTEM. PORTABLE.

Steel tube 100 x 80 mm coated with powder epoxi painting with treatment 200° C. Base made in steel tube with cavities for placing counter balance. 4 wheels for moving. Clearance space: 1,65 m

Anti-tilt system. Anchoring system with safety screws.

Comply with UNE-EN 1270.

**680 658** Juego de canastas basket trasladables con tableros de fibra, aros basculantes y redes. - Basketball system portable set with fiber backboards, hoop and nets.

**680 660** Juego de canastas basket trasladables con tableros de cristal templado, aros basculantes y redes. - Basketball system portable set with tempered glass backboards, hoop and nets.

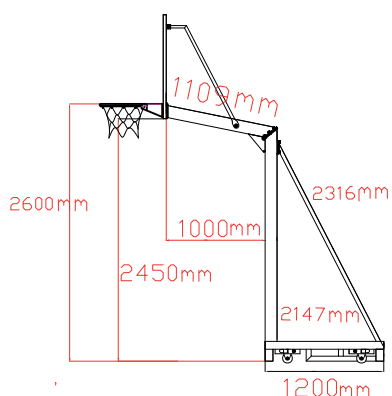

#### CANASTAS TRASLADABLES DE MINI-BASKET.

Juego de canastas trasladables de Mini Basket . Fabricadas en tubo de acero de 100mm. x 80 mm. pintados con pintura de polvo epoxi secado al horno a 200°. Base fabricada en tubo de acero, con cavidad para poner contrapesos o cajón metálico para hormigón. Sistema de 4 ruedas para su portabilidad, fácil transporte. Canastas con vuelo de 1 m . Sistema anti-vuelco de anclaje al suelo mediante tornillos de seguridad. Acorde a la normativa UNE-EN 1270.

#### MINIBASKETBALL SYSTEM. PORTABLE.

Steel tube 100 x 80 mm coated with powder epoxi painting with treatment 200° C. Base made in steel tube with cavities for placing counter balances. 4 wheels for moving. Clearance space: 1 m

Anti-tilt system. Anchoring system with safety screws.

Comply with UNE-EN 1270.

**680 670** Juego de canastas mini-basket trasladables con tableros de fibra, aros basculantes y redes. Minibasketball system portable set with fiber backboards, hoop and nets.

**680 672** Juego de canastas mini- basket trasladables con tableros de cristal templado, aros basculantes y redes. Minibasketball system portable set with tempered glass backboards, hoop and nets.

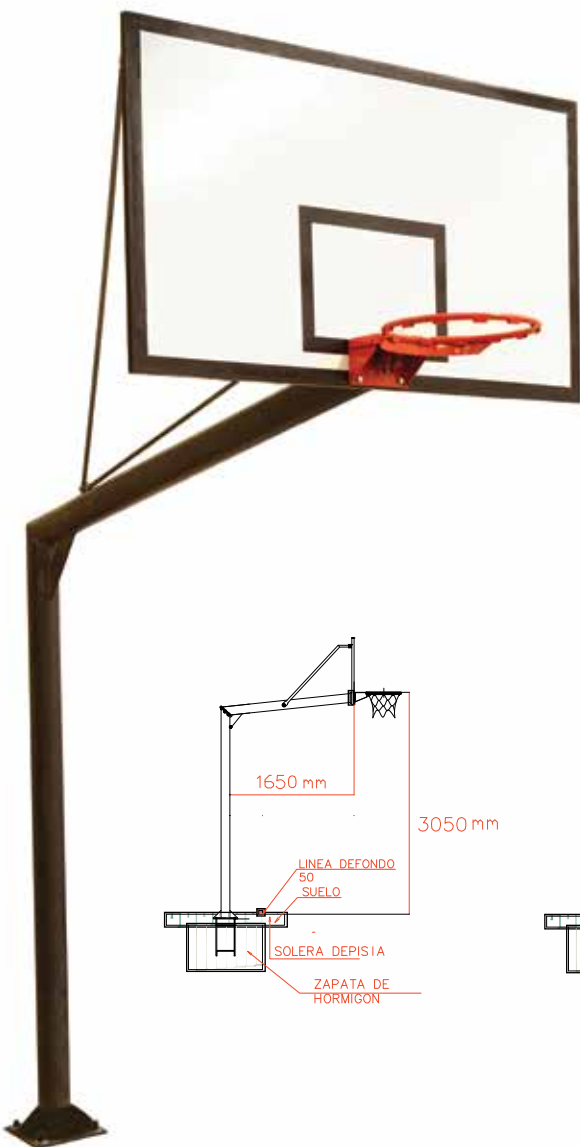

Postes de canastas fijas de Basket . Fabricadas en tubo de acero redondo. Pintados con pintura de polvo epoxi secado al horno a 200°. Anclajes al suelo mediante varillas roscadas unidas entre si para insertar en el cubo de hormigón. Acorde a la normativa UNE-EN 1270.

*Posts fixed for Basket. Made of round steel tube. Painted with epoxy powder paint drying oven to 200 °. Anchorage to the floor by threaded rods linked together to insert into the bucket of concrete. Baskets of 1.65 m flight. According to the UNE-EN 1270.*

**680 640** Juego de canastas basket fijas con postes redondos Ø 114 mm. x 3 mm de espesor. 2,25 m. de vuelo. Con tableros de fibra de 2 cm. Aros basculantes y redes.

**680 642** Juego de canastas basket fijas con postes redondos Ø 114 mm. x 3 mm de espesor. 2,25 m. de vuelo. Con tableros de cristal templado de 1,2 cm. Aros basculantes y redes.

**680 654** Juego de canastas basket fijas con postes redondos Ø 114 mm. x 3 mm de espesor. 1,65 m. de vuelo. Con tableros de fibra de vidrio de 2 cm. Aros basculantes y redes.

**680 656** Juego de canastas basket fijas con postes redondos Ø 114 mm. x 3 mm de espesor. 1,65 m. de vuelo. Con tableros decristal templado de 1,2 cm. Aros basculantes y redes.

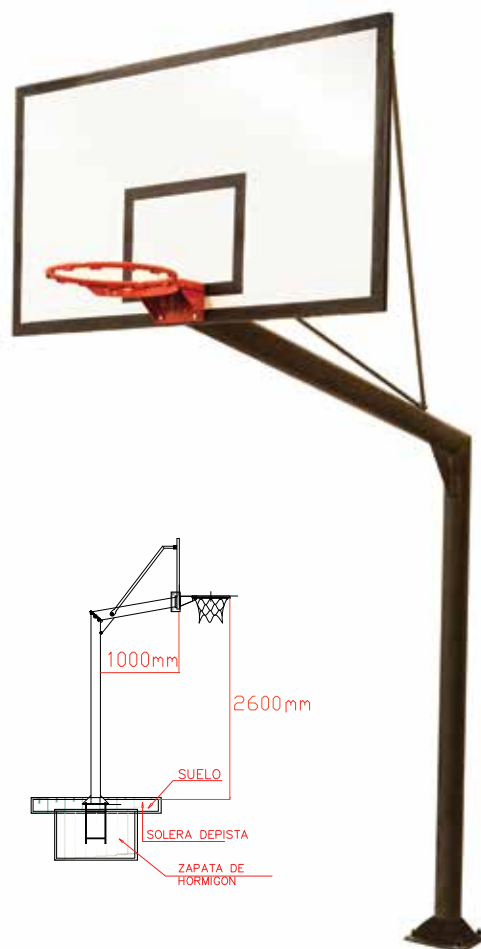
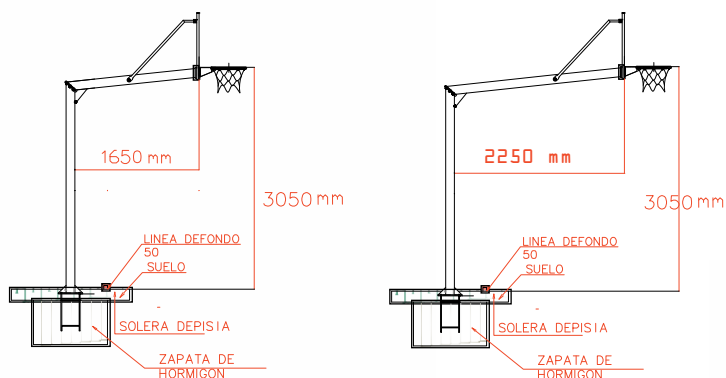

Juego de canastas fijas de Minibasket . Fabricadas en tubo de acero de 100 mm. de diámetro. Grosor de 3 mm. Pintados con pintura de polvo epoxi secado al horno a 200°. Anclajes al suelo mediante varillas roscadas unidas entre si para insertar en el cubo de hormigón. Canastas con vuelo de 1 m . Acorde a la normativa UNE-EN 1270.

*Basket Round Tube Posts. Set 2 pcs.*

*Fix Mini-basket set. Made of steel tube 100 mm. in diameter. Thickness 3 mm. Painted with epoxy powder drying oven to 200 °. Anchoring to the floor by threaded rods linked together to insert into the bucket of concrete. Baskets of 1 m flight. According to the UNE-EN 1270.*

**680 666** Juego de canastas mini-basket fijas con tableros de fibra, aros basculantes y redes.

*Minibasketball fixed set with fiber backboards, hoop and nets.*

**680 668** Juego de canastas mini-basket fijas con tableros de cristal templado, aros basculantes y redes.

*Minibasketball fixed set with tempered glass backboards, hoop and nets.*

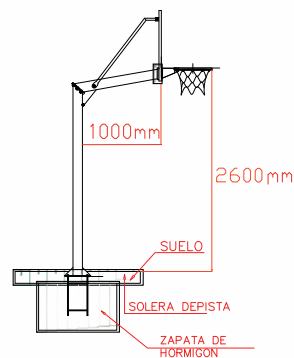



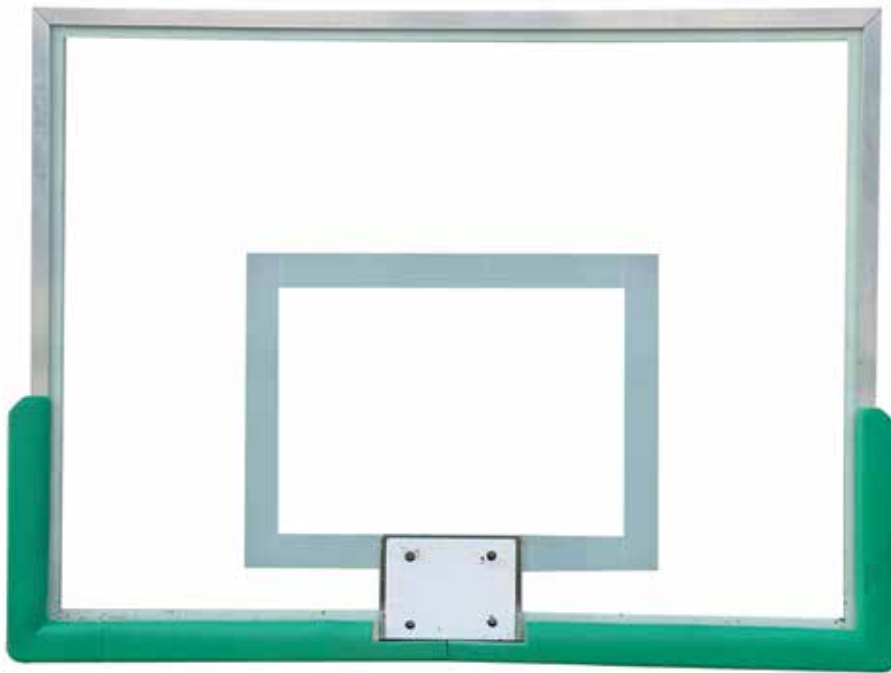

**680 601** Juego de tableros de basket de cristal templado de 180 x 105 x 1,2 cm con protecciones.

*Tempered glass basket backboard set with protections. 180 x 105 x 1,2 cm.*

**680 603** Juego de tableros de mini-basket de cristal templado de 120 x 90 x 1,2 cm. con protecciones.

*Tempered glass basket backboard set with protections. 120 x 90 x 1,2 cm.*

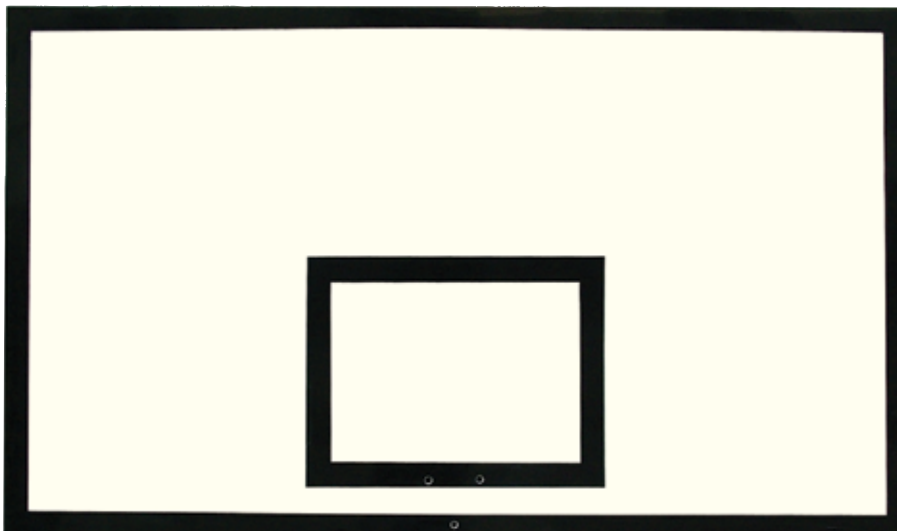

**680 602** Juego de tableros basket de fibra de 180 x 105 x 2 cm. - *Fiber basket backboard set 180 x 105 x 2 cm.*

**680 604** Juego de tableros mini-basket de fibra de 120 x 90 x 2 cm. - *Fiber mini-basket backboard set 120 x 90 x 2 cm.*



**680 605** Juego de aros, con muelles basculantes.

tubo de hierro de 2 cm macizo. Aro Reglamentario.

*Basketball hoop set.*

**690 000** Juego de redes de basket.

*Basketball net set.*



**680701 CANASTA STREET BASKET PRO.**

Canasta de Street Basket Profesional. Regulable en altura de 2,25 m a 3,05 m . Tablero acrílico de 112 cm x 72 cm x 3 cm. Base fabricada en PP, puede rellenarse de agua (110 kg.) o arena (120 kg.)

*STREET BASKET PROFESIONAL. HEIGHT ADJUSTMENT. BASE FILLED WITH WATER*  
*Street Basket Profesional basket system. Height adjustment from 2,25 m to 3,05 m. Acrylic backboard 112cm x 72cm x3cm. Base made of PP, filled with water or sand.*

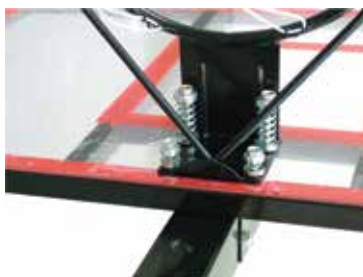

Detalle tablero y aro.  
*Board and hoop detail.*



Detalle manivela para ajustar altura.  
*Detail handle high adjustable.*



**680702 CANASTA STREET BASKET.**

Canasta de Street Basket. Regulable en altura de 1,60 m a 2,10 m . Tablero Americano. Base fabricada en PP, puede rellenarse de agua o arena.

*STREET BASKET. HEIGHT ADJUSTABLE. BASE FILLED WITH WATER*  
*Street Basket basket Goal. Height adjustment from 1,60m to 2,10 m. American backboard. Base made of PP and filled with water or sand.*



Detalle base. - Base detail.



Detalle trasera tablero.  
*Back board detail.*





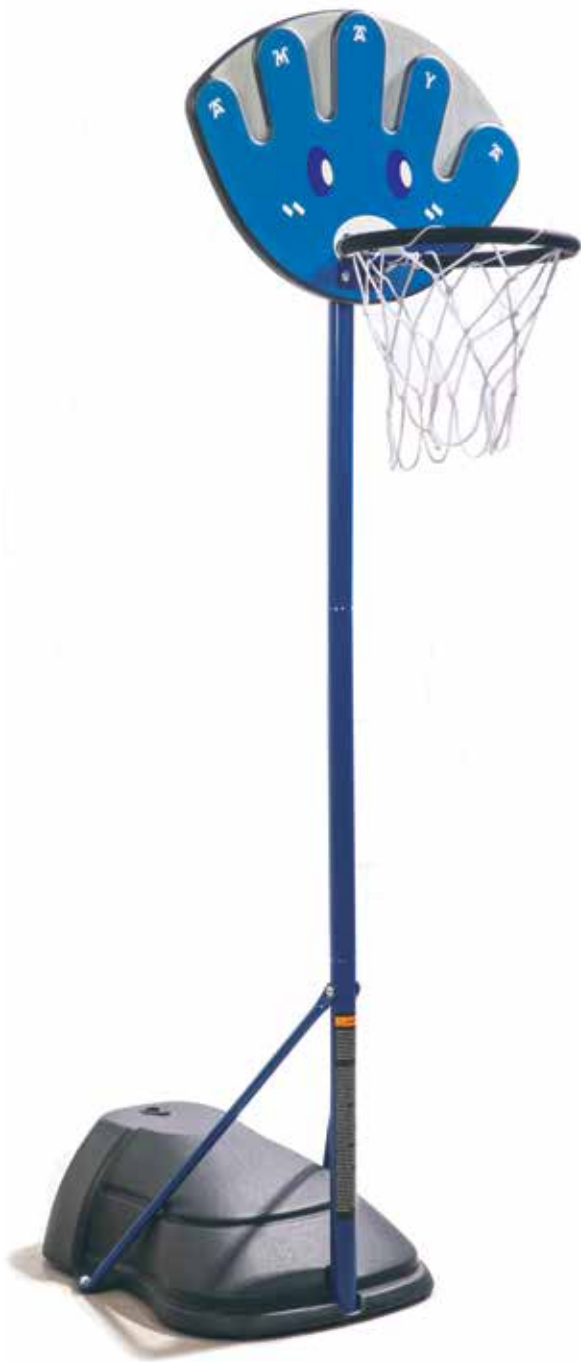

**680 704** BABY BASKET CON BASE RELLENABLE.

Canasta Baby Basket. Regulable en altura de 0,9 m a 1,35 m . Tablero Americano. Base fabricada en PP, puede rellenarse de agua o arena.

*BABY BASKET. FILLIABLE BASE WITH WATER*

*Baby Basket. Height adjustable from 0,9 m to 1,35 m. American Backboard. Base made in PP. Filled with water or sand.*



Detalle rueda para ajustar altura.  
*Weel for fixing height.*

**680703** NET BALL CON BASE RELLENABLE.

Net ball. Regulable en altura de 2,44 m a 3,05 m. Base fabricada en PP, puede rellenarse de agua o arena.

*NET BALL BASE FILLED WITH WATER*

*Net Ball. Height adjustable from 2,44 m to 3,05 m. Base made of PP and filled with water or sand.*



**700 190** Balón Volley "Soft-Touch" termosoldado blanco. Oficial. Laminación especial de muy alta calidad con suave textura. Exterior: Capa de poliuretano muy suave. Vejiga de butilo. Máximas prestaciones. Recomendado para competición. Ø 210 mm. 280 gr.  
*Volleyball "Soft-Touch" thermowelded Official. Special lamination, maximum quality, very soft. Outer material: Soft PU ply. Bladder: Butyl. Official weight and size. Maximum performance qualities. Recommended for competition.*

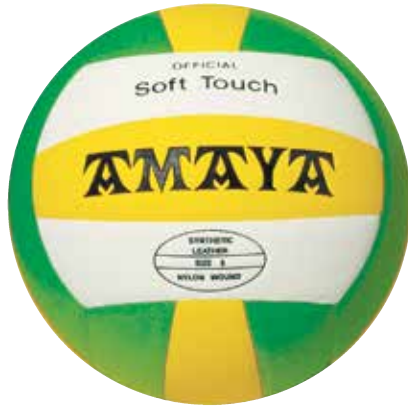

**700 191** Balón Volley "Soft-Touch" termosoldado tricolor. Oficial. Laminación especial de muy alta calidad con suave textura. Exterior: Capa de poliuretano muy suave. Vejiga de butilo. Máximas prestaciones. Recomendado para competición. Ø 210 mm. 280 gr.  
*Volleyball "Soft-Touch" thermowelded Official. Special lamination, maximum quality, very soft. Outer material: Soft PU ply. Bladder: Butyl. Official weight and size. Maximum performance qualities. Recommended for competition.*

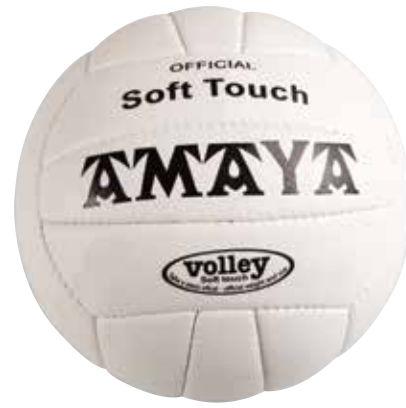

**700 161** Balón voleibol cuero sintético cosido. Interior: Tres capas laminadas en látex natural. Exterior: Capa de PU. Vejiga de butilo. Recomendado para iniciación y entrenamiento. Ø 210 mm. 280 gr.  
*Volleyball sewed synthetic leather. Inner lamination: Three ply pasted in natural latex. Outer material: One PU ply. Bladder: Butyl. Official size and weight. Recommended for initiation and training.*

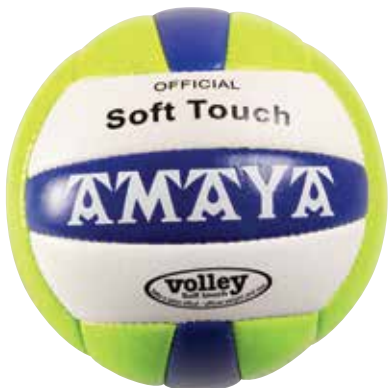

**700 180** Balón Volley cuero sintético. Interior: Tres capas laminadas en látex natural. Exterior: Capa de cuero sintético. Peso: 280 gr. Ø 210 mm. Recomendado para jugar en la playa.  
*Volleyball beach Sewed synthetic leather. Inner lamination: Three ply pasted in natural latex. Outer lamination: One leather synthetic ply. Weight: 280 gr. Ø 210 mm. Recommended for playing on the beach.*



**457 000** Balón volley foam recubierto de caucho especial. Lámina de caucho en una única pieza, muy resistente y con una excelente estabilidad. Toque suave. Sin válvula. No necesita hinchado debido a su alma de foam. Peso: 280 gr. Ø 210 mm.  
*Volleyball foam with rubber recover. Rubber lamination in one piece, very resistant and a good stability. soft touch. Suitable for schools Weight: 325 gr. Ø 190 mm.*

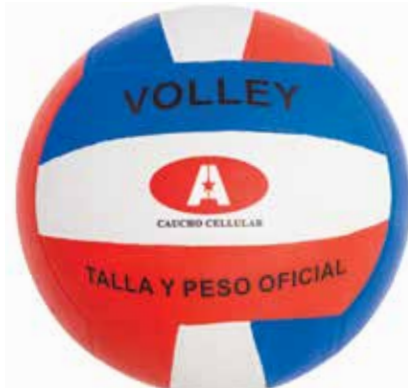

**700 163** Balón Volley caucho Cellular multicolor. Ø 210 mm. 280 gr.  
*Volleyball multicolored Cellular rubber. Ø 210 mm. 280 gr.*

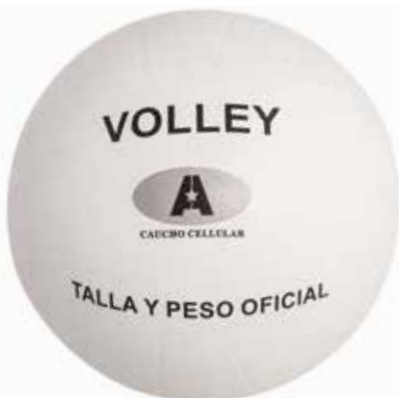

**700 164** Balón Volley caucho Cellular color blanco. Ø 210 mm. 280 gr.  
*Volleyball white color Cellular rubber. Ø 210 mm. 280 gr.*



**700 170** Balón voleibol termoplástico. Fabricado en una única pieza. Peso 260 gr. Ø 210 mm. Muy resistente y adecuado para patio de colegio.  
*Volleyball thermoplastic. Made in one piece. Weight: 260 gr. Ø 210 mm. Very resistant and suitable for school yard.*



**700 166** Volleyball Tecnocaucho®. Ø 210 mm.





**700 167** Balón voleibol soft TPE.  
Peso: 260 gr. Ø 210 mm.  
Volleyball Soft TPE. Weight: 260 gr. Ø 210 mm.



**700 171** Balón minivoleibol termoplástico. Fabricado en TPE en una única pieza. Peso: 230 gr. Ø 190 mm. Muy resistente y adecuado para patio de colegio.  
*Mini-volleyball THERMOPLASTIC. Made in one piece. Weight: 230 gr. Ø 190 mm. Very resistant and suitable for school yard.*



**700 174** Mini-Volleyball Tecnocaucho®.



**700 172** Balón mini-voleibol soft TPE.  
Peso: 230 gr. Ø 190 mm.  
*Mini-volleyball soft TPE.*  
Weight: 230 gr. Ø 190 mm.

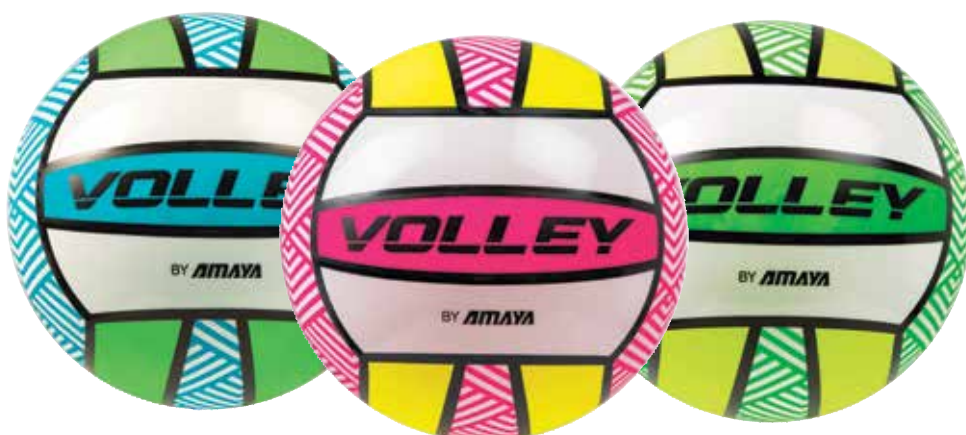

**70022800** BALÓN VOLLEY PLAYA DECORADO  
Fabricado en termoplástico. Peso 180 g. Diámetro 21cm.  
*Beach Volley. Made in Thermoplastic. Weight 180 g. Diameter 21 cm.*

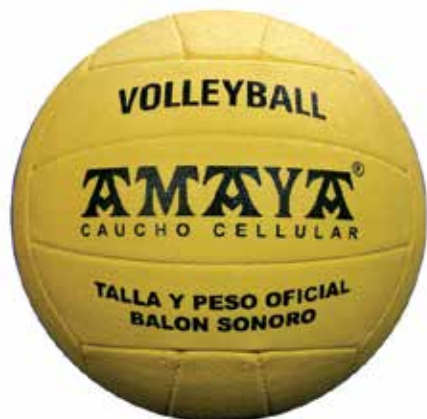

**466 100** Pelota sonora de caucho celular volley. Ø 210 mm. 270 gr.  
**SONORO**  
*Sonorous cellular rubber volley ball. Ø 210 mm. 270 gr.*



**700 234** Balón voley PVC. Ø 190 mm.  
*Volleyball PVC. Ø 190 mm.*



**443 505** Balón voley foam soft Ø 190 mm. 280 gr. Colores surtidos  
*Volleyball foam soft Ø 190 mm. 280 gr. Assorted colors.*

**VOLEIBOL - VOLLEYBALL**



### 680 301 POSTES DE VOLEY FIJOS OVALADOS DE ALUMINIO.

Postes de Voleibol de competición fabricados en perfil de aluminio anodizado de 140 mm. x 100 mm.. Con refuerzos interiores para mayor robustez. Sistema de tensado de red integrado en los postes mediante un carro regulable en altura, fabricado en acero zincado. Admite el tensado de red en las diferentes alturas oficiales dependiendo de la categoría, además de altura para bádminton y tenis.

Incluye sistema de anclaje al suelo. Acorde a la normativa UNE-EN 1271:2004

*VOLLEYBALL POSTS. FIXED. OVAL ALUMINIUM PROFILE.*

*Aluminium oval profile 140 x 100 mm. Reinforced inwardly for greater resistance and robustness. Tensing net system inside the posts with height regulable plataform which is made in zincated steel.*

*The net can be tensed in all the official Volley heights, moreover Badminton and Tennis heights. Include anchoring system.*

*Comply with UNE-EN 1271:2004*



### 680 303 POSTES DE VOLEY FIJOS CUADRADOS DE ALUMINIO.

Postes de Voleibol de competición fabricados en perfil de aluminio anodizado de 80 mm. x 80 mm. con cantos redondeados. Con refuerzos interiores para mayor robustez. Sistema de tensado de red integrado en los postes mediante un carro regulable en altura, fabricado en acero zincado. Admite el tensado de red en las diferentes alturas oficiales dependiendo de la categoría, además de altura para bádminton y tenis.

Incluye sistema de anclaje al suelo. Acorde a la normativa UNE-EN 1271:2004

*VOLLEYBALL POSTS. FIXED.COMPETITION. SQUARE.*

*Aluminium rounded edges profile 80 x 80 mm. Reinforced inwardly for greater resistance and robustness. Tensing net system inside the posts with height regulable plataform which is made in zincated steel. The net can be tensed in all the official Volley heights, moreover Badminton and Tennis heights. Include anchoring system.*

*Comply with UNE-EN 1271:2004*



### 680 302 POSTES DE VOLEY TRASLADABLES OVALADOS DE ALUMINIO.

Postes de Voleibol de competición fabricados en perfil de aluminio anodizado de 140 x 100. Con refuerzos interiores para mayor robustez. Sistema de tensado de red integrado en los postes mediante un carro regulable en altura, fabricado en acero zincado. Admite el tensado de red en las diferentes alturas oficiales dependiendo de la categoría, además de altura para bádminton y tenis. Base realizada en acero pintado con pintura de polvo epoxi secado al horno a 200°. Incluye sistema anti-vuelco mediante tornillos de seguridad. No incluye contrapesos. Acorde a la normativa. UNE-EN 1271:2004.

*VOLLEYBALL POSTS. TRANSPORTABLE.COMPETITION. OVAL ALUMINIUM PROFILE.*

*Aluminium oval profile 140 x 100 mm. Reinforced inwardly for greater resistance and robustness. Tensing net system inside the posts with height regulable plataform which is made in zincated steel.*

*The net can be tensed in all the official Volley heights, moreover Badminton and Tennis heights. Steel base coated with epoxi painting treated to 200°C. Includes anti-tilt system with safety screws.*

*Without counterbalance. Comply with UNE-EN 1271:2004*

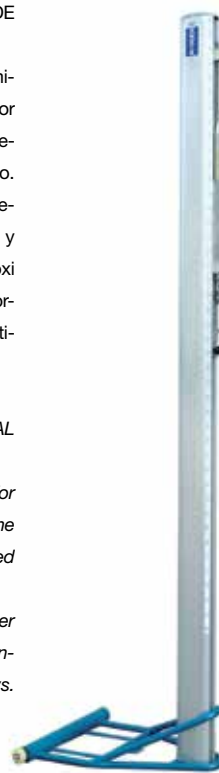

### 680 304 POSTES DE VOLEY TRASLADABLES CUADRADOS DE ALUMINIO.

Postes de Voleibol de competición fabricados en perfil de aluminio anodizado de 80 mm. x 80 mm. con cantos redondeados. Con refuerzos interiores para mayor robustez. Sistema de tensado de red integrado en los postes mediante un carro regulable en altura, fabricado en acero zincado. Admite el tensado de red en las diferentes alturas oficiales dependiendo de la categoría, además de altura para bádminton y tenis. Base realizada en acero pintado con pintura de polvo epoxi secado al horno a 200°. Incluye sistema anti-vuelco mediante tornillos de seguridad. No incluye contrapesos. Acorde a la normativa. UNE-EN 1271:2004

*VOLLEYBALL POSTS. TRANSPORTABLE.COMPETITION. SQUARE*

*Aluminium rounded edges profile 80 x 80 mm Reinforced inwardly for greater resistance and robustness. Tensing net system inside the posts with height regulable plataform which is made in zincated steel.*

*The net can be tensed in all the official Volley heights, moreover Badminton and Tennis heights. Steel base coated with epoxi painting treated to 200°C. Includes anti-tilt system with safety screws. Without counterbalance.*

*Comply with UNE-EN 1271:2004*



### 690 003 RED DE VOLEY OFICIAL.

Medidas: 970 x 90 cm.

*OFICIAL VOLLEY NET. Meassure: 970 x 90 cm.*



### 439 400 Set de voley y tenis, ancho 4 m. Alturas: 1m. para tenis, 2 m. para voley.

*Set volley and tennis, lenght 4 m. Height: 1 m. for tennis, 2 m. for volley.*



### 439 300 Gran base universal Ø 42 cm. alto 15 cm.

*Big universal base Ø 42 cm. height: 15 cm.*





671 300



671 303



671 302



671 301

671 300 Raqueta tenis AT-33-M, armazón de aluminio, empuñadura de PU y cordaje de nylon. 69 cm. - *Tennis racket AT-33-M 69 cm.*

671 301 Raqueta tenis escolar alevín. Fabricada en aluminio. Medidas: 21 x 53 cm. - *Tennis racket mod. alevín. Aluminium 100%. Measures 21 x 53 cm.*

671 302 Raqueta tenis escolar junior. Fabricada en aluminio. Medidas: 23 x 58 cm. - *Tennis racket mod. junior. Aluminium 100%. Measures 23 x 58 cm.*

671 303 Raqueta tenis senior. Fabricada en aluminio. Medidas: 25 x 63 cm. - *Tennis racket mod. senior. Aluminium 100%. Measures 25 x 63 cm.*



800 410 Pelota tenis presurizada. Bote de 3 unidades. *Tennis ball. Pressurized can with 3 balls.*



800 411 Pelota tenis Champion. Bolsa de 3 unidades. *Tennis ball Champion. Plastic 3 u.*



800 419 Pelota frontenis reglamentaria. Bote de 2 unidades. Colores: Azul y amarillo. *Official rubber Frontennis ball for playing with tennis racket. Tube 2 u. Color: Color: Blue and yellow.*



Pelota mini-tennis oficial. Pelota ideal para la iniciación en el deporte del tenis. La más utilizada en las escuelas de tenis de todo el mundo. Más ligera y blanda que una pelota normal. Acorde a la normativa de la ITF para los más pequeños. *Mini tennis official balls. Recommended for introducing into the tennis sport. On fashion in all tennis schools now. Lighter and softer than usual balls. According to ITF norm for children.*

800 414 Set 3 unidades. *Set 3 units.*

800 416 Bote 100 unidades. *Bucket with 100 units.*



800 413 Cubo pelotas tenis baja presión. Bote medio. 100 unidades. *Tennis ball in bucket 100 u. Low pressure. Medium bounce.*

## 680 200 POSTES DE TENIS Y PADEL FIJOS OVALADOS DE ALUMINIO.

Postes de Tenis/Paddle de competición fabricados en perfil de aluminio anodizado de 140 x 100. Con refuerzos interiores para mayor robustez. Sistema interno de tensado de red. Incluye sistema de anclaje al suelo. Acorde a la normativa UNE-EN 1520:1996.

*TENNIS/PADDLE POSTS. COMPETITION. FIXED. OVAL ALUMINIUM PROFILE.*

*Aluminium oval profile 140 x 100 mm. Reinforced inwardly for greater resistance and robustness. Tensing net system. Anchoring system. Comply with UNE-EN 1520:1996*



## 680 202 POSTES DE TENIS Y PADEL FIJOS CUADRADOS DE ALUMINIO.

Postes de Tenis/Paddle de competición fabricados en perfil de aluminio anodizado de 80 mm. x 80mm. con cantos redondeados. Con refuerzos interiores para mayor robustez. Sistema interno de tensado de red. Incluye sistema de anclaje al suelo. Acorde a la normativa UNE-EN 1520:1996.

*TENNIS/PADDLE POSTS. COMPETITION. FIXED SQUARES*

*Aluminium oval profile 80 x 80 mm. Reinforced inwardly for greater resistance and robustness. Tensing net system. Anchoring system.*

*Comply with UNE-EN 1520:1996*



## 690 005 RED TENIS TRIPLE DE COMPETICIÓN. TENNIS COMPETITION NET.

## 680 201 POSTES DE TENIS Y PADEL TRASLADABLES OVALADOS DE ALUMINIO.

Postes de Tenis/Paddle de competición fabricados en perfil de aluminio anodizado de 140 x 100. Con refuerzos interiores para mayor robustez. Sistema interno de tensado de red. Base realizada en acero pintado con pintura de polvo epoxi secado al horno a 200°. Incluye sistema anti-vuelco mediante tornillos de seguridad. No incluye contrapesos. Acorde a la normativa UNE-EN 1520:1996.

*TENNIS/PADDLE POSTS. COMPETITION. PORTABLE. OVAL ALUMINIUM*

*Aluminium oval profile 140 x 100 mm. Reinforced inwardly for greater resistance and robustness. Tensing net system.*

*Base coated with epoxi painting treated to 200°C. Includes anti-tilt system with safety screws. Without counterbalance*

*Comply with UNE-EN 1520:1996*



## 680 203 POSTES DE TENIS Y PADEL TRASLADABLES CUADRADOS DE ALUMINIO.

Postes de Tenis/Paddle de competición fabricados en perfil de aluminio anodizado de 80 mm. x 80mm. con cantos redondeados. Con refuerzos interiores para mayor robustez. Sistema interno de tensado de red. Base realizada en acero pintado con pintura de polvo epoxi secado al horno a 200°. Incluye sistema anti-vuelco mediante tornillos de seguridad. No incluye contrapesos. Acorde a la normativa UNE-EN 1520:1996.

*TENNIS/PADDLE POSTS. COMPETITION. TRANSPORTABLE. SQUARE.*

*Aluminium rounded edges 80 x 80 mm. Reinforced inwardly for greater resistance and robustness. Tensing net system.*

*Steel base coated with epoxi painting treated to 200°C. Includes anti-tilt system with safety screws. Without counterbalance.*

*Comply with UNE-EN 1520:1996*







**670 474 00**

Raqueta badminton School color azul. Fabricada en Acero. Unión T.  
Longitud 66cm. Peso: 108 gr.  
*School Badminton racket blue color. Made in steel. T union. Length: 66cm. Weight: 108 gr.*



**670 473 00**

Raqueta badminton School color amarillo. Fabricada en Acero. Unión T.  
Longitud 61cm. Peso: 103 gr.  
*School Badminton racket yellow color. Made in steel. T union. Length 61 cm. Weight: 103 gr.*



**67047200**

Raqueta badminton School color verde. Fabricada en Acero. Unión T.  
Longitud 54cm. Peso: 100 gr.  
*School Badminton racket green color. Made in steel. T union. Length 54cm. Weight: 100 gr.*



**67047100**

Raqueta badminton School color morado. Fabricada en Acero. Unión T.  
Longitud 47cm. Peso: 95 gr.  
*School Badminton racket purple color. Made in steel. T union. Length 47cm. Weight: 95 gr.*



**670 503** Raqueta de badminton HQ-55. Grafito 100%. Una única pieza. Funda completa. Longitud: 66 cm. Peso: 90 gr. Sin cordaje.

*Badminton racket HQ-55. Graphite 100%. One piece. Complete cover. Length: 66 cm. Weight: 90 gr.*



**670 502** Raqueta de badminton HQ-25. Aluminio y carbono. Una única pieza. Funda cabeza. Longitud: 66 cm. Peso: 88 gr.

*Badminton racket HQ-25. Aluminium and carbon. One piece. Half cover. Length: 66 cm. Weight: 88 gr.*



**670 501** Raqueta de badminton HQ-15. Aluminio y carbono. Unión T. Funda cabeza. Longitud: 67 cm. Peso: 95 gr.

*Badminton racket HQ-15. Aluminium and carbon with T union. Half cover. Length: 67 cm. Weight: 95 gr.*



**670 500** Raqueta de badminton HQ-5. Aluminio. Unión T. Media funda. Longitud: 66 cm. Peso: 106 gr.

*Badminton racket HQ-5. Aluminium with T union. Half cover. Length: 66 cm. Weight: 106 gr.*



**670 504** Raqueta de badminton HQ-35. 100% CARBONO. Una única pieza. Funda cabeza. Longitud: 66 cm. Peso: 82 gr.



**670 450** Set 4 raquetas de badminton con postes, red, 2 volantes y bolso. Raquetas: Fabricadas en Aluminio. Unión T. Funda cabeza. Longitud: 66,5 cm. Peso: 117 gr.

Volante: Fabricado en plástico con cabeza de corcho. Longitud: 8cm Peso: 2g  
Postes : Fabricados en acero. Longitud: 180cm

Red: Fabricada en poliestireno. Longitud: 6m x 55cmA partir de 5 años.

*Set 4 badminton rackets, 2 flyers, net, bag. Rackets: made of aluminium. T union. Head cover. Length: 66,5 cm. Weight: 117 gr.*

*Shuttlecock: made of plastic with cork head. Length: 8 cm. Weight: 2 g.*

*Posts: made of steel. Length: 180 cm.*





**670 702** Volante de badminton de vinilo. Color rojo. Velocidad rápida.  
*Vynil badminton shuttlecock. Red colour. Fast speed.*



**670 701** Volante de badminton de vinilo. Color azul. Velocidad media.  
*Vynil badminton shuttlecock. Blue colour. Medium speed.*



**670 700** Volante de badminton de vinilo. Color verde. Velocidad lenta.  
*Vynil badminton shuttlecock. Green colour. Slow speed.*



**670 910** Volantes badminton en plástico blanco con cabeza de corcho. Bote de 6 unidades.  
*Badminton shuttlecock in white plastic with cork head. Can 6 pcs.*



**670 900** Volantes badminton en plástico, colores. Con cabeza de corcho. Bolsa Badminton shuttlecock in color plastic. Can 6 pcs.

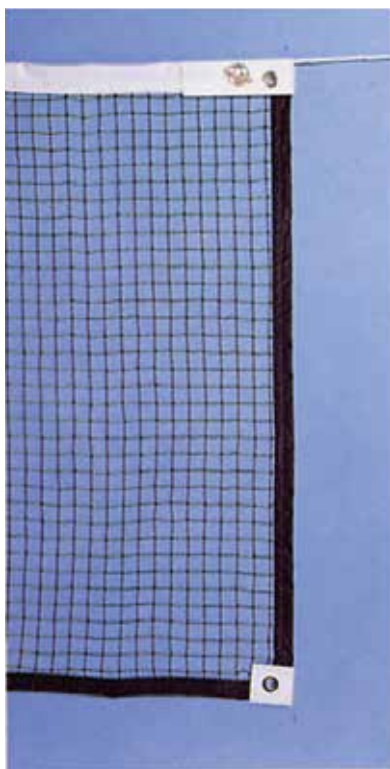

**690 004** Red de badminton. Fabricada en nylon. Medida : 6,10 x 0,76 m.  
*Badminton net. Made of nylon. Measure: 6,10 x 0,76 m.*



**43931500 RED BADMINTON**



#### **43930200 JUEGO VOLLEY-BADMINTON**

Conjunto Volley-Badminton ajustable y trasladable  
School system (2 postes largos + 2 bases + red).

#### **43930100 JUEGO BADMINTON-TENIS**

Conjunto Badminton-Tenis ajustable y trasladable  
School System (2 postes cortos +2 bases + red)



#### **680 400 POSTES DE BADMINTON TRASLADABLES**

Conjunto de postes de Bádminton trasladables. Fabricados en tubo de acero de 45mm., pintados con pintura de polvo epoxi a secado al horno a 200°. Tensado mediante carraca.. Base fabricada también en acero, con ruedas incorporadas para su fácil transporte. Con contrapesos. Acorde a la normativa UNE-EN 2009.

#### *BADMINTON POSTS. TRANSPORTABLE*

*Set made of steel 45 mm coated with powder epoxi painting with treatment to 200°C. Tensed with ratchet.*

*Base made in steel, with wheels for moving. Comply with UNE-EN 2009.*



**SERIE L:** Innovación tecnológica en el tenis de mesa. Palas de tenis de mesa de máxima calidad. Nuevos mangos PRO revolucionarios más ligeros, perforados lateralmente. Mayor absorción del golpe y menor vibración.

**SERIE L:** *Tennis table rackets high quality, made with high quality materials. New PRO REVOLUTION handle lighter and with lateral holes. Improve vibration control.*

**SERIE M:** Palas de Tenis de Mesa de máxima calidad, fabricadas con los mejores materiales.

**SERIE M:** *Tennis table rackets high quality.*

SERIE M	Velocidad / Speed	Control	Efecto / Spin	Esponja / Sponge	Material	Uso / Usage
1002	5	6	5	1.5 mm.	7 capas de madera - 7 wood layers.	Principiantes - beginners
3002	5	6	6	1.8 mm.	7 capas madera de pino. - 7 pine wood layers.	Colegios - schools
SERIE L						
2802	5	5	6	1.8 mm.	7 capas madera de tilo. - 7 tile wood layers.	Aficionados - amateur
5802	6	6	7	2 mm.	7 capas madera de tilo - 7 tile wood layers.	Clubs



**672 800 PALA TENIS MESA L5802 5 estrellas mango PRO**

Pala tenis de mesa L5802.

*Tennis table rackets L5802 5 stars PRO HANDLE.*



**672 700 PALA TENIS MESA L3802 3 estrellas mango PRO**

Pala tenis de mesa M3002. Pala de tenis de mesa de alta calidad.

Fabricada en 7 capas de madera de tilo Medida: 26 x 15 cm. Grosor: 13 mm. Peso: 170 gr. A partir de 8 años.

*Tennis table rackets M3002 3 stars.*



**672 600 PALA TENIS MESA L2802 2 estrellas mango PRO**

Pala tenis de mesa L2802. Pala de tenis de mesa de máxima calidad. Nuevo mango PRO más ligero. Mayor absorción del golpe y menor vibración. Fabricada en 7 capas de madera de tilo. Velocidad: 5. Control: 5. Efecto Spin: 6. Esponja: 1.8 mm. Medida: 26 x 15 cm. Grosor: 13 mm. Peso: 170 gr. A partir de 10 años.

*Tennis table rackets L2802 2 stars PRO HANDLE.*



**672 400 PALA TENIS MESA 1 estrellas. Set de 2 palas + 3 pelotas**

Set 2 Palas Tenis de Mesa M1002 1 estrella + 3 Pelotas Iniciación.

*Set 2 tennis table rackets M1002 1 star + 3 initiating balls.*



**672 851 Pelota tenis mesa, caja de 6 unidades.**

*Table tennis balls. 6 units box.*



**672 850 Pelota tenis mesa bolsa de 100 unidades.**

*Table tennis balls. 100 units bag.*



PELOTA VASCA - BASQUE PELOTA



**590 220** Pelota mano cuero "Goxua infantil". Peso: 55 - 60 gr. Edad: 12 - 13. - *Leather fronton ball for playing with the hand "Goxua infantil". Weight: 55-60 gr. Age: 12 -13.*

**590 225** Pelota mano cuero "Goxua kadete". Peso: 60 - 65 gr. Edad: 14 - 15. - *Leather fronton ball for playing with the hand "Goxua kadete". Weight: 60-65 gr. Age: 14 -15.*

**590 230** Pelota mano cuero "Goxua juvenil". Peso: 65 - 70 gr. Edad: 16 - 17. - *Leather fronton ball for playing with the hand "Goxua juvenil". Weight: 65-70 gr. Age: 16 -17.*

**590 235** Pelota mano cuero "Goxua senior". Peso: 70 - 75 gr. Edad: >18. - *Leather fronton ball for playing with the hand "Goxua senior". Weight: 70-75 gr. Age: > 18.*



**454 501** Pelota frontón, Ø 58 mm.  
Blister de 3 unidades.  
*Coated foam ball to play in pediment, Ø 58 mm. Blister 3 u.*



**443 920** Pelota frontón pala foam,  
Ø 55 mm. Peso 30 gr.  
*Foam ball to play in pediment, Ø 55 mm. Weight 30 gr.*





**442 815** Bate baseball foam. Ø 70 mm x 61 cm. Incluye pelota de Ø 75 mm.  
Foam baseball bat. O 70 mm. x 61 cm. Ball included 75 mm.

**442 805** Pelota beisbol Ø 70 mm. - Baseball ball Ø 70 mm.

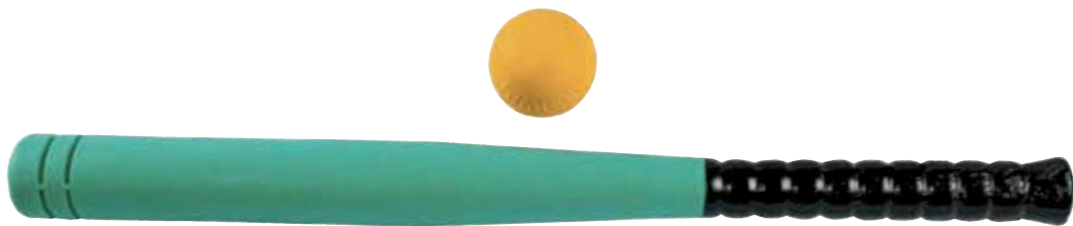

**442 803** Bate de beisbol foam con pelota. - Foam baseball bat & ball.

**442 805** Pelota de beisbol foam. - Foam baseball ball Ø 70 mm.



**454 800** Bate de beisbol foam recubierto - Coated foam baseball bat & balle.



641 055 Bate de madera de 66 cm. - *Wooden bat 66 cm.*

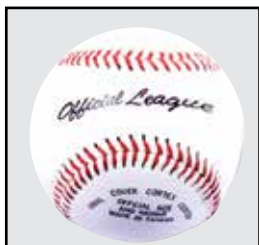

641 060 Pelota de beisbol.  
en cuero.  
*Leather baseball.*



641 065 Pelota de softball.  
*Softball.*



641 020 Guante de beisbol napo 22.80 cm. - *Napo baseball glove 22.80 cm.*  
641 025 Guante de beisbol napo 26.60 cm. - *Napo baseball glove 26.60 cm.*



641 050 Soporte de pelota para batear.  
*Ball support to bat.*



641 045 Casco bateador de pvc.  
Talla S: 19 X 16 cm. - Talla M: 19,5 X 16,5 cm. - Talla L: 20 X 17 cm.  
*Pitcher helmet pvc. S, M and L size.*



641 030 Casco con máscara de catcher.  
*Catcher Helmet with mask.*





**641 000** Máscara de catcher beisbol senior.  
*Senior catcher baseball mask.*



**641 005** Máscara de catcher softball junior.  
*Junior catcher softball mask.*

**641 035** Máscara de catcher softball senior.  
*Senior catcher softball mask.*



**641 010** Protector de cuerpo de catcher senior.  
*Senior Catcher body protector.*

**641 015** Protector de cuerpo de catcher junior.  
*Junior Catcher body protector.*



**641 040** Protector de piernas catcher.  
*Catcher legs protector.*



**610 121** Soporte baseball regulable de 0,75 a 1,25 m. Base de 3 Kg.  
*Baseball adjustable support. from 0,75 to 1,25 m. Base 3 Kg.*





**570 920** Valla de salto de aluminio Senior. Regulable en altura de 76 a 106 cm.  
Aluminium Athletic hurdle Senior. Height adjustable from 76 to 106 cm.



**570 922** Valla de salto de plástico iniciación. Regulable en altura de 55 a 95 cm.  
Plastic athletic hurdle initiation. Height adjustable from 55 to 95 cm.

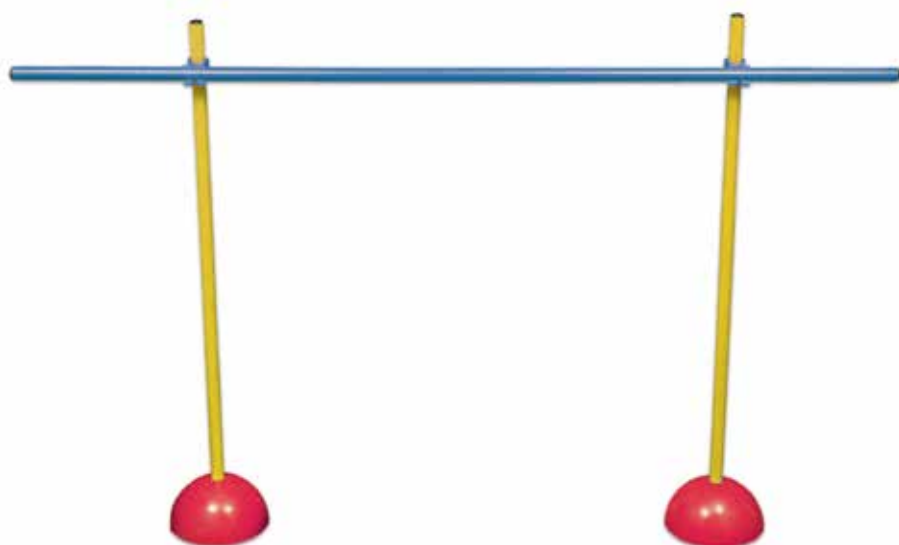

**432 503** Kit entrenamiento: 2 bases macizas de 1,8 kg., 3 picas de 1,60 m y 2 engarces.  
Training kit: 2 solid bases 1,8 kg., 3 sticks 1,60 m and 2 links for stick.

**432 507** Kit entrenamiento: 2 bases huecas rellenas de arena, 3 picas de 1,60 m y 2 engarces.  
Training kit 2: 2 empty sand filled bases, 3 sticks 1,60 m and 2 links for stick.



**432 510** Base rellenable hueca con base antideslizante. Ø 24 cm  
Hollow base. Fillable with nonslip base. Ø 24 cm.



**610 106** Valla de salto regulable, de 45 a 80 cm. de altura. Base lastrada. - Adjustable hurdle. Height: from 45 to 80 cm. Ballasted base.

**610 107** Valla de salto regulable, de 25 a 40 cm. de altura. Base lastrada. - Adjustable hurdle. Height: from 25 to 40 cm. Ballasted base.

**610 108** Valla de salto regulable, de 15 a 20 cm. de altura. Base lastrada. - Adjustable hurdle. Height: from 15 to 20 cm. Ballasted base.

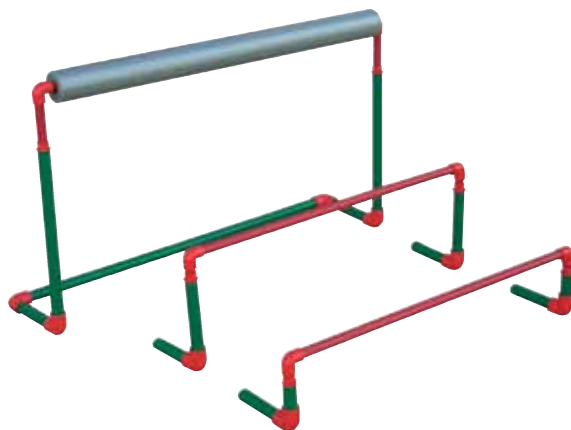





**540 000** Disco lanzamiento 800 gr. - *Throwing disk 800 gr.*  
**540 100** Disco lanzamiento 1 kg. - *Throwing disk 1 kg.*  
**540 200** Disco lanzamiento 1,5 kg. - *Throwing disk 1,5 kg.*  
**540 300** Disco lanzamiento 2 kg. - *Throwing disk 2 kg.*



**570 910** Testigos de aluminio. Set de 6 ud.  
 Medidas: 30 cm. x Ø 3,5 cm.  
*Aluminium batons. Set 6 ud.*  
*Meassure: 30 c. x Ø 3,5 cm.*



**570 912** Testigos de pvc. Set de 6 ud.  
*Pvc batons. Set 6 ud.*



**560 100** Pelota lanzamiento javalina 600 gr. - *Training javeling ball 600 gr.*  
**560 200** Pelota lanzamiento javalina 800 gr. - *Training javeling ball 800 gr.*



**570 100** Pelota lanzamiento de peso 1 kg. - *Training throwing ball 1 kg.*  
**570 200** Pelota lanzamiento de peso 1,5 kg. - *Training throwing ball 1,5 kg.*  
**570 300** Pelota lanzamiento de peso 2 kg. - *Training throwing ball 2 kg.*  
**570 400** Pelota lanzamiento de peso 2,5 kg. - *Training throwing ball 2,5 kg.*  
**570 500** Pelota lanzamiento de peso 3 kg. - *Training throwing ball 3 kg.*

**570 600** Pelota lanzamiento de peso 4 kg. - *Training throwing ball 4 kg.*  
**570 700** Pelota lanzamiento de peso 5 kg. - *Training throwing ball 5 kg.*  
**570 800** Pelota lanzamiento de peso 6,25 kg. - *Training throwing ball 6,25 kg.*  
**570 900** Pelota lanzamiento de peso 7,25 kg. - *Training throwing ball 7,25 kg.*



**570 950** Saltómetro escolar 2,5 m. Con bases contrapesadas. Set 2 un.

Fabricado totalmente en acero galvanizado y pintado con pintura epoxi; secado a altas temperaturas, para evitar la corrosión. Altura del listón regulable de 50 a 250 cm. Se puede desmontar fácilmente para su transporte. Base lastrada con pies de goma.

*High-Jump for School 2.5 m. With bases counterbalanced. Set 2 pcs.*

*Made entirely of galvanized steel and painted with epoxy paint, high temperature drying, to prevent corrosion. Bar height adjustable from 50 to 250 cm. Can be disassembled easily for transport. Base burdened with rubber feet.*

**570 955** Listón para saltómetro de fibra de vidrio. Longitud 4 m.

*High-Jump Bar of fiberglass. Length 4 m.*

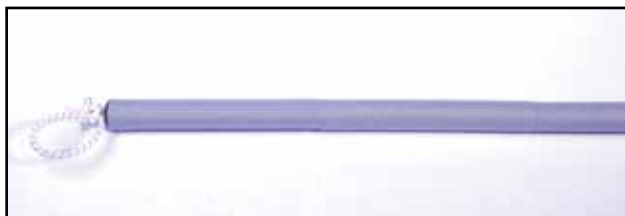

**570 956** Listón para saltómetro antilesión foam de 4 metros de longitud. Listón totalmente seguro fabricado con cilindros de tubo espumado, con una goma interior. Utilizado para entrenamientos por los campeones de salto de altura de todo el mundo. Elimina el miedo al salto.

*Bar for High-Jump made of foam anti-injury. Length 4 meters. Bar high security, made with foam cylinders with inner rubber. Used all over the world, eliminates the fear of jumping.*





**700 223** Balón rugby Cellular T 5. Talla y peso oficial.  
Rugby Cellular T 5. Official size and weight.



**700 224** Balón mini-rugby Cellular T 3. Talla y peso oficial.  
Mini rugby Cellular T 3. Official size and weight.



**442 900** Balón rugby. Peso: 150 gr. Perímetro: 640 x 410 mm.  
Football rugby ball. Weight: 150 gr. Perimeter: 640 x 410 mm.



**454 701** Balón rugby foam recubierto. Peso: 168 gr. Perímetro: 640 x 410 mm.  
Foam rugby ball. Weight: 168 gr. Perimeter: 640 x 410 mm.

# 6

## GIMNASIA RÍTMICA *RHYTHMIC GYMNASTIC*





# AROS - HOOPS

**ARO DE GIMNASIA HR (High Resilience) COMPETICIÓN - GYMNASTICS HOOP HR COMPETITION**

**EFFECTO MUELLE - SPRING EFFECT**

**NUEVO SISTEMA DE UNIÓN - NEW FIXING SYSTEM**

Fabricado en nuevo material elástico con efecto muelle interior para recuperar la forma rápidamente. Por su elevada resiliencia alcanza una altura máxima al rebote. Nuevo sistema de unión antirotura. Color blanco. Peso mínimo 300g. Sello FIG impreso. Válidos para competición internacional.

Made with new synthetic elastic material with spring effect inside. Thanks to its high resilience the rebound reaches a maximum height. New fixing system anti break. Minimum weight: 300 g. Stamp FIG printed. For international competition.

**310 024** Aro de gimnasia HR competición Ø 80 cm. Sección 18 mm. - *Gymnastics hoop HR competition Ø 80 cm. Section 18 mm.*

**310 026** Aro de gimnasia HR competición Ø 85 cm. Sección 18 mm. - *Gymnastics hoop HR competition Ø 85 cm. Section 18 mm.*

**310 027** Aro de gimnasia HR competición Ø 89 cm. Sección 18 mm. - *Gymnastics hoop HR competition Ø 89 cm. Section 18 mm.*

**310 022** Aro de gimnasia HR competición JUNIOR 75 cm. Sección 18 mm. - *Gymnastic hoop HR competition JUNIOR 75 cm. Section 18 mm.*

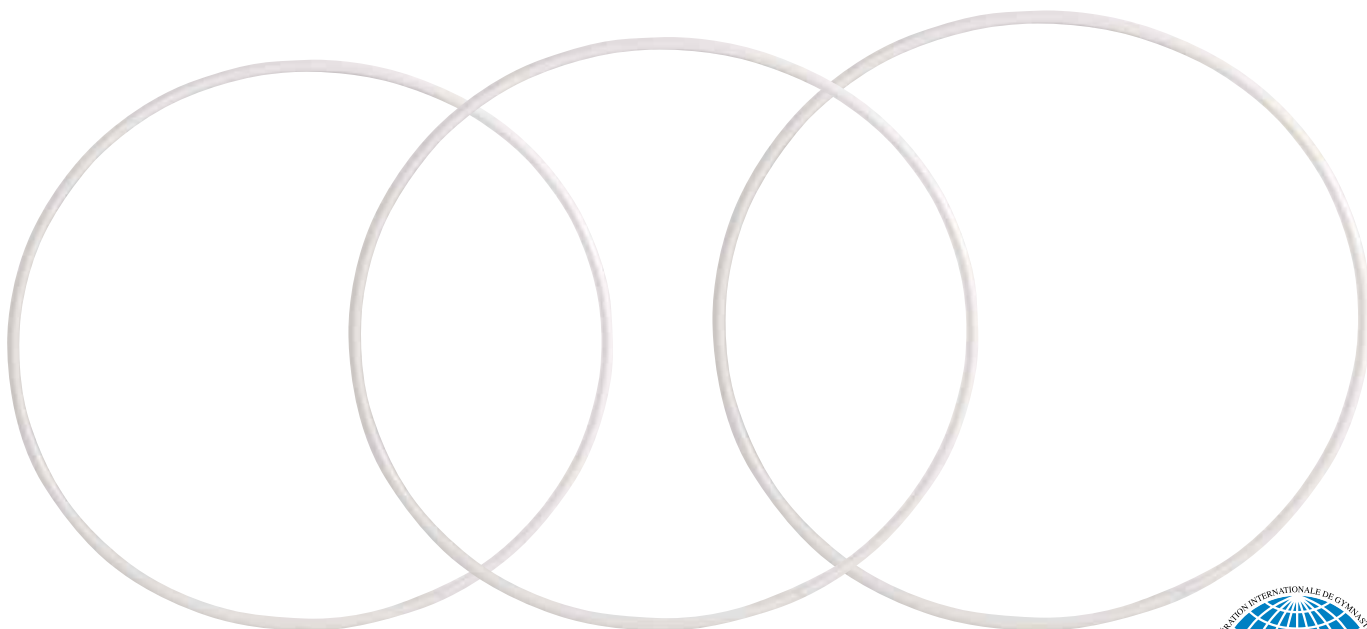

<p>FÉDÉRATION INTERNATIONALE DE GYMNASTIQUE</p> <p><i>Certificate</i></p> <p>ACCREDITÉ / ACCREDITÉ A <b>AMAYA SPORT S.L.</b></p> <p>We hereby confirm that the apparatus mentioned below adheres to the FIG norms and may therefore be used at all FIG events, as well as those of its Continental Unions and Affiliated Federations.</p> <p>Nous attestons que les appareils de gymnastique mentionnés ci-dessous répondent aux exigences de la FIG et peuvent être utilisés dans toutes les manifestations de la FIG, ainsi que celles des Unions Continentales et Fédérations Affiliées.</p> <p><b>Hoop</b> <b>Apparatus ID: 503</b></p> <p>This Certificate is valid until / Ce Certificat est valable jusqu'à <b>June 17th, 2023</b></p> <p>FEDERATION INTERNATIONALE DE GYMNASTIQUE Luzern, June 17th, 2023 Maurice Wabre Président Nicolas Bourgeois Secretary General</p>	<p>FÉDÉRATION INTERNATIONALE DE GYMNASTIQUE</p> <p><i>Certificate</i></p> <p>ACCREDITÉ / ACCREDITÉ A <b>AMAYA SPORT S.L.</b></p> <p>We hereby confirm that the apparatus mentioned below adheres to the FIG norms and may therefore be used at all FIG events, as well as those of its Continental Unions and Affiliated Federations.</p> <p>Nous attestons que les appareils de gymnastique mentionnés ci-dessous répondent aux exigences de la FIG et peuvent être utilisés dans toutes les manifestations de la FIG, ainsi que celles des Unions Continentales et Fédérations Affiliées.</p> <p><b>Hoop</b> <b>Apparatus ID: 506</b></p> <p>This Certificate is valid until / Ce Certificat est valable jusqu'à <b>June 17th, 2023</b></p> <p>FEDERATION INTERNATIONALE DE GYMNASTIQUE Luzern, June 17th, 2023 Maurice Wabre Président Nicolas Bourgeois Secretary General</p>	<p>FÉDÉRATION INTERNATIONALE DE GYMNASTIQUE</p> <p><i>Certificate</i></p> <p>ACCREDITÉ / ACCREDITÉ A <b>AMAYA SPORT S.L.</b></p> <p>We hereby confirm that the apparatus mentioned below adheres to the FIG norms and may therefore be used at all FIG events, as well as those of its Continental Unions and Affiliated Federations.</p> <p>Nous attestons que les appareils de gymnastique mentionnés ci-dessous répondent aux exigences de la FIG et peuvent être utilisés dans toutes les manifestations de la FIG, ainsi que celles des Unions Continentales et Fédérations Affiliées.</p> <p><b>Hoop</b> <b>Apparatus ID: 505</b></p> <p>This Certificate is valid until / Ce Certificat est valable jusqu'à <b>June 17th, 2023</b></p> <p>FEDERATION INTERNATIONALE DE GYMNASTIQUE Luzern, June 17th, 2023 Maurice Wabre Président Nicolas Bourgeois Secretary General</p>	<p>FÉDÉRATION INTERNATIONALE DE GYMNASTIQUE</p> <p><i>Certificate</i></p> <p>ACCREDITÉ / ACCREDITÉ A <b>AMAYA SPORT S.L.</b></p> <p>We hereby confirm that the apparatus mentioned below adheres to the FIG norms and may therefore be used at all FIG events, as well as those of its Continental Unions and Affiliated Federations.</p> <p>Nous attestons que les appareils de gymnastique mentionnés ci-dessous répondent aux exigences de la FIG et peuvent être utilisés dans toutes les manifestations de la FIG, ainsi que celles des Unions Continentales et Fédérations Affiliées.</p> <p><b>Hoop</b> <b>Apparatus ID: 504</b></p> <p>This Certificate is valid until / Ce Certificat est valable jusqu'à <b>June 17th, 2023</b></p> <p>FEDERATION INTERNATIONALE DE GYMNASTIQUE Luzern, June 17th, 2023 Maurice Wabre Président Nicolas Bourgeois Secretary General</p>
---	---	---	---

## ARO COMPETICIÓN - ELITE HOOP

Fabricado en polietileno. Reforzado en su interior. Válidos para competición nacional.

Made of polyethylene. Reinforced inside. For national competition.

**310 034** Aro sección 18mm COMPETICION 80cm. - Hoop section 18mm COMPETITION 80 cm.

**310 032** Aro sección 18mm COMPETICION 85cm. - Hoop section 18mm COMPETITION 85 cm.

**310 030** Aro sección 18mm COMPETICION 89cm. - Hoop section 18mm COMPETITION 89 cm.



TABLA DE COLORES - COLOUR TABLE

TABLA DE COLORES FLUOR  
FLUOR COLOUR TABLE

1	2	3	5	7	9	11	12	15	13	16	4	6	8	10
blanco white	rosa claro light pink	amarillo yellow	azul claro light blue	rojo red	verde rayo green	azulón dark blue	morado purple	lila light purple	negro black	turquesa turquoise	amarillo yellow	verde green	naranja orange	fucsia fuchsia



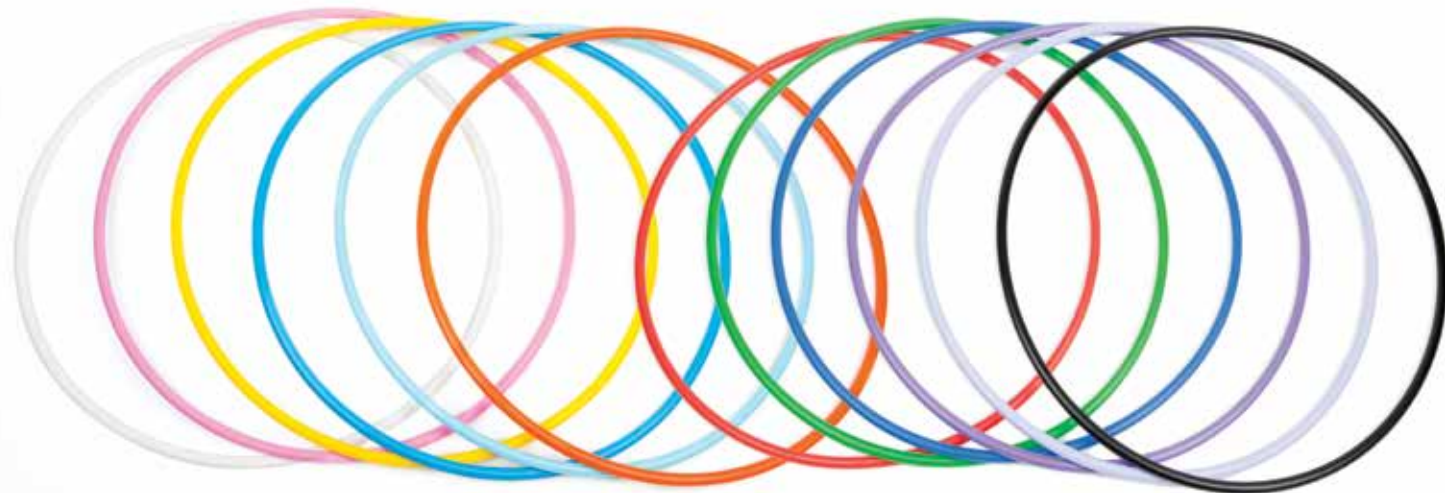
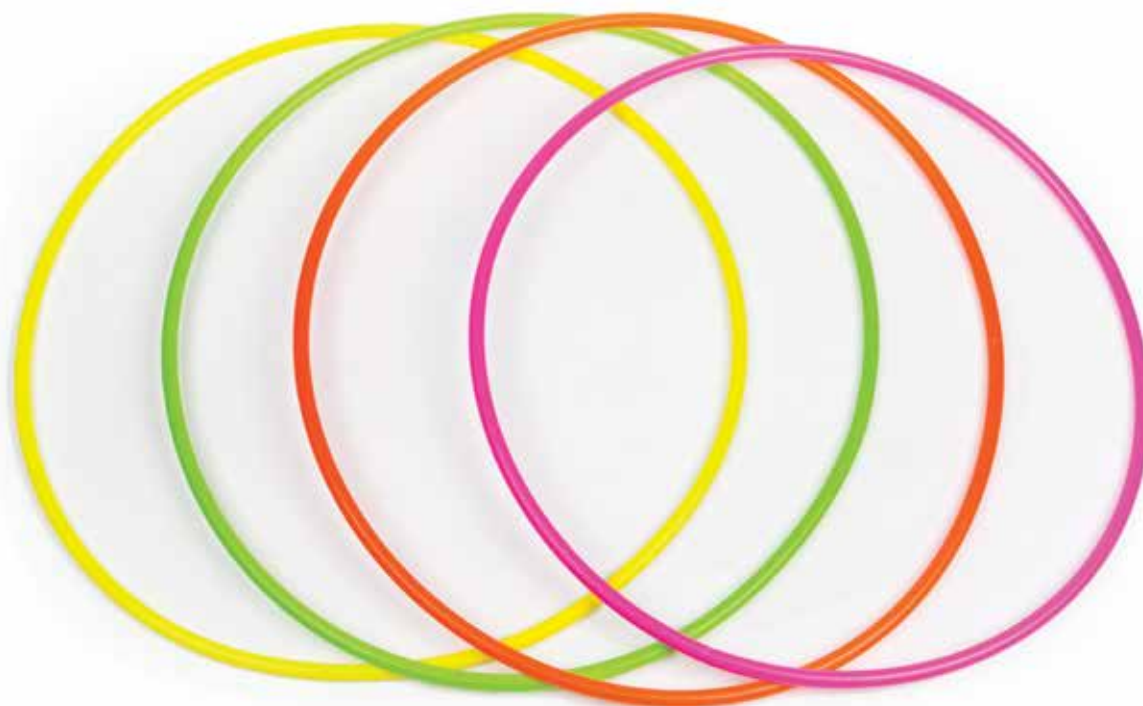

## AROS ENTRENAMIENTO - TRAINING HOOP

**310 040** Aro sección 18mm ENTRENAMIENTO 70cm.

**310 038** Aro sección 18mm ENTRENAMIENTO 75cm.

**310 036** Aro sección 18mm ENTRENAMIENTO 80cm.

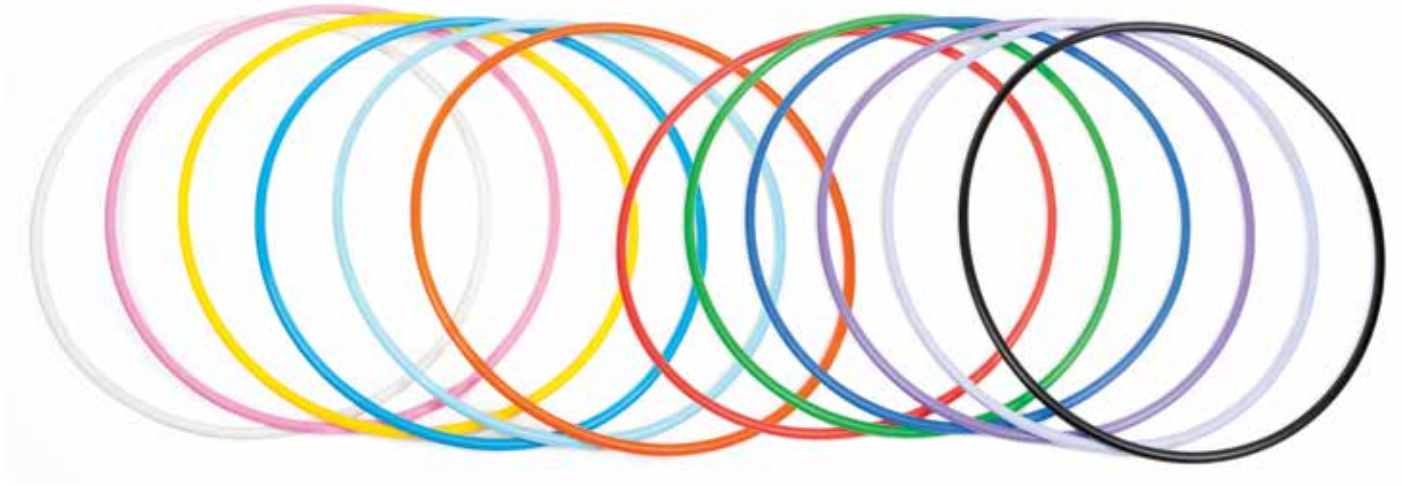

### TABLA DE COLORES - COLOUR TABLE

1	2	3	5	7	9	11	12	15	13	16
blanco white	rosa claro light pink	amarillo yellow	azul claro light blue	rojo red	verde rayo green	azulón dark blue	morado purple	lila light purple	negro black	turquesa turquoise

### TABLA DE COLORES FLUOR FLUOR COLOUR TABLE

4	6	8	10
amarillo yellow	verde green	naranja orange	fucsia fuchsia



## 360 280 CUBIERTA ARO ELÁSTICA - ELASTIC COVER FOR HOOP

Válido para todos los tamaños. Colores: fucsia, morado, verde, negro y azul.  
*Suitable for all sizes. Color: fuchsia, purple, green, black and blue.*

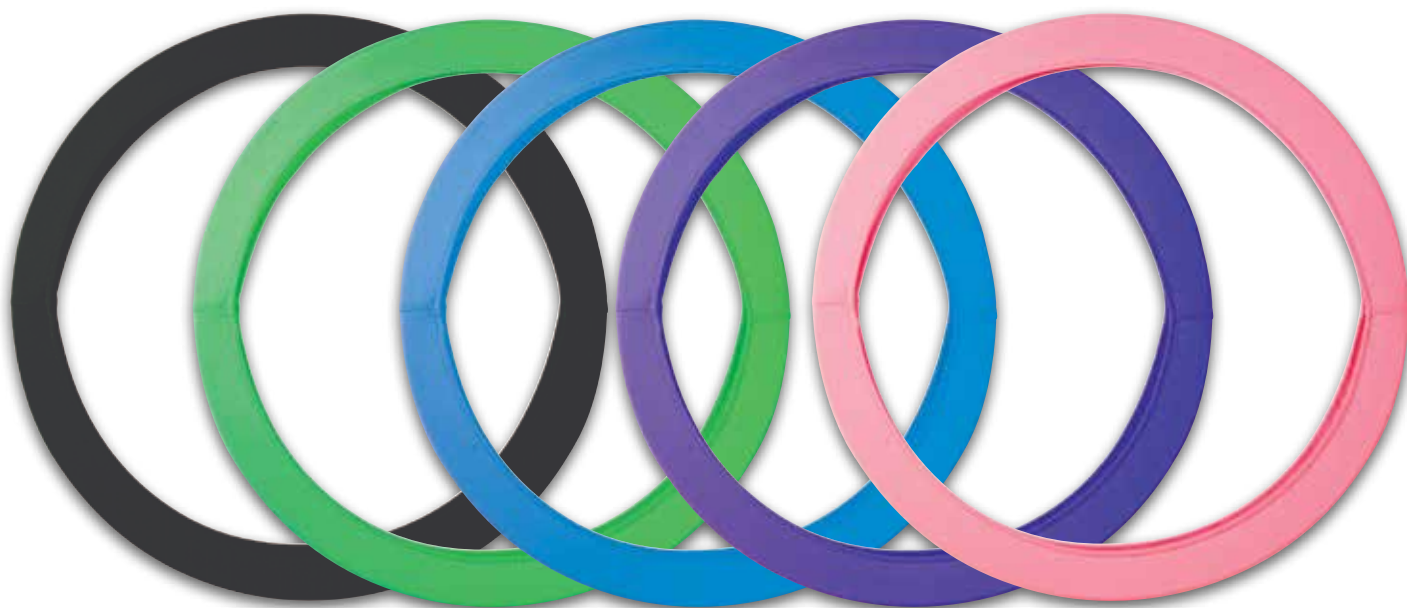

360 280 13

360 280 18

360 280 16

360 280 12

360 280 10

## 360 285 BOLSO PORTA-APARATOS MODELO UNIVERSAL - UNIVERSAL RHYTHMIC GYMNASTICS BAG

Bolso porta aparatos modelo universal. Fabricado en lycra y nylon de alta calidad. Colores: Pistacho, fucsia, turquesa y gris.  
Con compartimentos interiores para todos los aparatos.  
*Universal rhythmic gymnastics bag made of lycra and high quality nylon. Colors: Pistachio green, fuchsia, turquoise and grey.*  
*With compartments for all apparatus.*



360 285 14

360 285 18

360 285 16

360 285 10



## 360 290 BOLSO PORTA-APARATOS MODELO VICTORIA - RHYTHMIC GYMNASTICS BAG VICTORIA'S

Bolso porta-aparatos modelo Victoria. Fabricado en nylon de alta calidad. Con compartimentos interiores para todos los aparatos. Con asas. Colores: Pistacho, fucsia, turquesa y gris. - *Made of high quality nylon with zip closure so you can easily store inside your articles.*  
 Colors: Pistachio green, fuchsia, turquoise and grey.



360 290 14

360 290 18

360 290 16

360 290 10

## 360 295 BOLSO PORTA-APARATOS MODELO CONJUNTO RHYTHMIC GYMNASTICS TEAMS BAG SET MODEL

Bolso porta aparatos modelo Conjunto. Fabricado en nylon de alta calidad. Válido para 6 conjuntos de aparatos. Con asas. Color: Gris. Con compartimentos interiores para todos los aparatos. - *Made of high quality nylon. The bag can contain the full equipment for one team.*



## 360 300 BOLSO PORTA-APARATOS MODELO CLASSIC CLASSIC RHYTHMIC GYMNASTICS BAG

Bolso porta aparatos Ø 82 cm. Colores negro, azulón, verde claro y fucsia. Con compartimentos interiores para todos los aparatos- Bag for rg apparatus Ø 82 cm. Colors: black, deep blue, light green and fuchsia.



# CINTAS ADHESIVAS - ADHESIVE TAPES



**CINTA ADHESIVA CAMALEON  
CHAMALEON ADHESIVE TAPE**

**CINTA ADHESIVA CAMALEON FLUOR  
FLUOR CHAMALEON ADHESIVE TAPE**



**360 504 01**  
Blanco perla



**360 504 07**  
Rojo



**360 504 09**  
Verde



**360 504 10**  
Fucsia



**360 505 25**  
Amarillo



**360 505 26**  
Naranja



**360 505 27**  
Fucsia



**360 505 28**  
Verde



**360 504 12**  
Morado



**360 504 14**  
Plata



**360 504 16**  
Turquesa



**360 504 20**  
Oro



## CINTA ADHESIVA MODELO RADIANT RADIANT MODEL ADHESIVE TAPE



360 506 01  
Blanco



360 506 02  
Rosa



360 506 05  
Morado



360 506 11  
Azul



360 506 06  
Verde



360 506 08  
Naranja

## CINTA ADHESIVA MODELO PURPURINA METAL MODEL ADHESIVE TAPE



360 502 07  
Rojo



360 502 08  
Naranja



360 502 09  
Verde



360 502 10  
Rosa



360 502 11  
Azul oscuro



360 502 12  
Morado



360 502 13  
Negro



360 502 14  
Plata



360 502 16  
Turquesa



360 502 20  
Oro

## CINTA ADHESIVA MODELO ESTRELLAS STARS MODEL ADHESIVE TAPE



360 508 02  
Rosa claro



360 508 06  
Verde claro



360 508 10  
Fucsia



360 508 12  
Morado



360 508 14  
Plata



360 508 15  
Violeta



360 508 16  
Turquesa



360 508 20  
Oro

## CINTA ADHESIVA MODELO SIRENA SIREN MODEL ADHESIVE TAPE



360 507 06  
Verde



360 507 08  
Naranja



360 507 10  
Fucsia



360 507 11  
Azul oscuro



360 507 13  
Negro



360 507 14  
Plata



360 507 15  
Violeta



360 507 16  
Turquesa



360 507 20  
Oro



360 507 02  
Rosa

## CINTA ADHESIVA MODELO ARCOIRIS RAINBOW MODEL ADHESIVE TAPE



360 509 02  
Rosa claro



360 509 07  
Rojo



360 509 08  
Naranja



360 509 10  
Fucsia



360 509 13  
Negro



360 509 15  
Violeta



360 509 16  
Turquesa



360 509 20  
Oro

## CINTA ADHESIVA MODELO ESPEJO MIRROR MODEL ADHESIVE TAPE



360 510 06  
Verde claro



360 510 07  
Rojo



360 510 08  
Naranja



360 510 09  
Verde



360 510 10  
Fucsia



360 510 13  
Negro



360 510 14  
Plata



360 510 15  
Violeta



360 510 16  
Turquesa



360 510 20  
Oro

## THERMOCAUCHO

### MAZAS ENGARZABLES BICOMPONENTES (CUELLO NEGRO)

**320 006 00** Mazas bicomponentes. Base de tecnocaucho colores surtidos y cuello de termoplástico color negro. Engarzables. Peso mínimo 150 g/pieza. Longitud 45.5 . Sello FIG impreso. Válidas para competición internacional. / *Double injection Club. Techno-rubber body assorted color and thermo plastic neck black color. Connectables. Minimum weight 150 g/u. Lenght: 45.5 cm. FIG printed. For international competition.*

**320 007 00** Mazas bicomponentes. Base de tecnocaucho colores surtidos y cuello de termoplástico color negro. Engarzables. Peso mínimo 150 g/pieza. Longitud 41.5 cm. Sello FIG impreso. Válidas para competición internacional. / *Double injection Club. Techno-rubber body assorted color and thermo plastic neck black color. Connectables. Minimum weight 150 g/u. Lenght: 41.5 cm. FIG printed. For international competition.*

**320 017 00** Mazas bicomponentes. Base de tecnocaucho colores surtidos y cuello de termoplástico color negro. Engarzables. Peso mínimo 105 g/pieza. Longitud 36 cm. / *Double injection Club. Techno-rubber body assorted color and thermo plastic neck black color. Connectables. Minimum weight 105 g/u. Lenght: 36 cm..*



## THERMOCAUCHO

### MAZAS ENGARZABLES BICOMPONENTES (CUELLO FUCSIA)

**320 008 00** Mazas bicomponentes. Base de tecnocaucho colores surtidos y cuello de termoplástico color fucsia. Engarzables. Peso mínimo 150 g/pieza. Longitud: 45,5 cm. Sello FIG impreso. Válidas para competición internacional

*Double injection Club . Techno-rubber body assorted color and thermo plastic neck pink color. Minimum weight 150 g sinble club. Lenght: 45,5 cm. Stamp FIG printed. For international competition.*

**320 009 00** Mazas bicomponentes. Base de tecnocaucho colores surtidos y cuello de termoplástico color fucsia. Engarzables. Peso mínimo 150 g/pieza. Longitud: 41,5 cm. Sello FIG impreso. Válidas para competición internacional

*Double injection Club . Techno-rubber body assorted color and thermo plastic neck pink color. Minimum weight 150 g sinble club. Lenght: 41,5 cm. Stamp FIG printed. For international competition.*

**320 018 00** Mazas bicomponentes. Base de tecnocaucho colores surtidos y cuello de termoplástico color fucsia. Engarzables. Peso mínimo 105 g/pieza. Longitud: 36 cm.

*Double injection Club . Techno-rubber body assorted color and thermo plastic neck pink color. Minimum weight 105 g sinble club. Lenght 36 cm.*





**MAZAS - CLUBS**

FÉDÉRATION INTERNATIONALE DE GYMNASTIQUE



*Certificate*

accorded to / accordé à  
**AMAYA SPORT S.L.**

We hereby confirm that the apparatus mentioned below adheres to the FIG norms and may therefore be used at all FIG events, as well as those of its Continental Unions and Affiliated Federations

Nous attestons que les appareils de gymnastique mentionnés ci-dessous répondent aux exigences de la FIG et peuvent être utilisés dans toutes les manifestations de la FIG, ainsi que celles des Unions Continentales et Federations Affiliées

**Clubs**  
**Apparatus ID: 104**

This Certificate is valid until / Ce Certificat est valable jusqu'au  
**October 31st, 2023**



FEDERATION INTERNATIONALE DE GYMNASTIQUE



Lausanne, October 31st, 2019  
Morianari Watanabe President  
Nicolas Buompane Secretary General

FÉDÉRATION INTERNATIONALE DE GYMNASTIQUE



*Certificate*

accorded to / accordé à  
**AMAYA SPORT S.L.**

We hereby confirm that the apparatus mentioned below adheres to the FIG norms and may therefore be used at all FIG events, as well as those of its Continental Unions and Affiliated Federations

Nous attestons que les appareils de gymnastique mentionnés ci-dessous répondent aux exigences de la FIG et peuvent être utilisés dans toutes les manifestations de la FIG, ainsi que celles des Unions Continentales et Federations Affiliées

**Clubs**  
**Apparatus ID: 117**

This Certificate is valid until / Ce Certificat est valable jusqu'au  
**October 31st, 2023**



FEDERATION INTERNATIONALE DE GYMNASTIQUE



Lausanne, October 31st, 2019  
Morianari Watanabe President  
Nicolas Buompane Secretary General

GIMNASIA RÍTMICA - RHYTHMIC GYMNASTIC



**THERMOPLASTIC**

**MAZAS LISAS ENGARZABLES  
CONNECTABLE CLUBS**

320 202 Mazas de Termoplástico competición lisa de 41 cm. Peso mínimo: 152 g. - Thermoplastic competition clubs 41 cm. Weight: 152 g.



**THERMOPLASTIC**

**MAZAS INFANTILES ENGARZABLES 36 CM.  
CHILDREN CONNECTABLE CLUBS 36 CM.**

320 401 Maza infantil 36 cm. Peso mínimo: 105 gr. Con sistema para engarzar base con cabeza.  
Children Rhythmic club. Length: 36cm. Weight: 105 gr. With base system for crimping head.



**GIMNASIA RÍTMICA - RHYTHMIC GYMNASTIC**



# CINTAS - RIBBON

## CINTAS DE COMPETICIÓN Y ENTRENAMIENTO COMPETITION AND TRAINING RIBBONS

**CINTA COMPETICIÓN.** Nuevo material. Seda especial anti-arrugas. Muy ligera. **COMPETITION RUBBER.** New material. Silk special anti-wrinkle. Very lightly.

**330 200** Cinta competición 6 m., con varilla. Sello FIG impreso. Válidas para competición internacional. **Competition ribbons 6 m. With stick. FIG printed. For international competition.**

**330 550** Cinta competición 5 m., con varilla. Sello FIG impreso. Válidas para competición internacional. **Competition ribbons 5 m. With stick. FIG printed. For international competition.**

**CINTA ENTRENAMIENTO.** Satén máxima calidad. **TRAINING RIBBON.** Satin high quality

**330 300** Cinta entrenamiento 6 m., con varilla. - **Training ribbons 6 m. With stick.**

**330 400** Cinta entrenamiento 4 m., con varilla. - **Training ribbons 4 m. With stick.**

**330 415** Cinta especial colegios 5 m., con varilla. Colores: Blanco, rosa, celeste, rojo, verde, azulón, morado, verde fluor, amarillo fluor, fucsia fluor, naranja fluor. - **School special ribbons 5 m. With stick. Colours: pink, blue sky, red, green, deep blue, purple, fluor green, fluor yellow, fluor fuchsia, fluor, orange.**



GIMNASIA RÍTMICA - RHYTHMIC GYMNASTIC

### TABLA DE COLORES - COLOUR TABLE



1 2 3 5 6 7 10 11 12 13 14 16 17 20 09 15

1 blanco - 2 rosa - 3 amarillo - 5 celeste - 6 verde claro - 7 rojo - 9 verde rayo - 10 fucsia - 11 azulón - 12 morado - 13 negro - 14 gris plata - 15 lila - 16 turquesa - 17 guinda - 20 oro.

1 white - 2 pink - 3 yellow - 5 sky blue - 6 soft green - 7 red - 9 ray green - 10 fuchsia - 11 deep blue - 12 purple - 13 black - 14 silver grey - 15 lilac - 16 turquoise blue - 17 cherry red - 20 gold



### TABLA DE COLORES FLUORESCENTES



amarillo rosa naranja verde  
yellow pink orange green



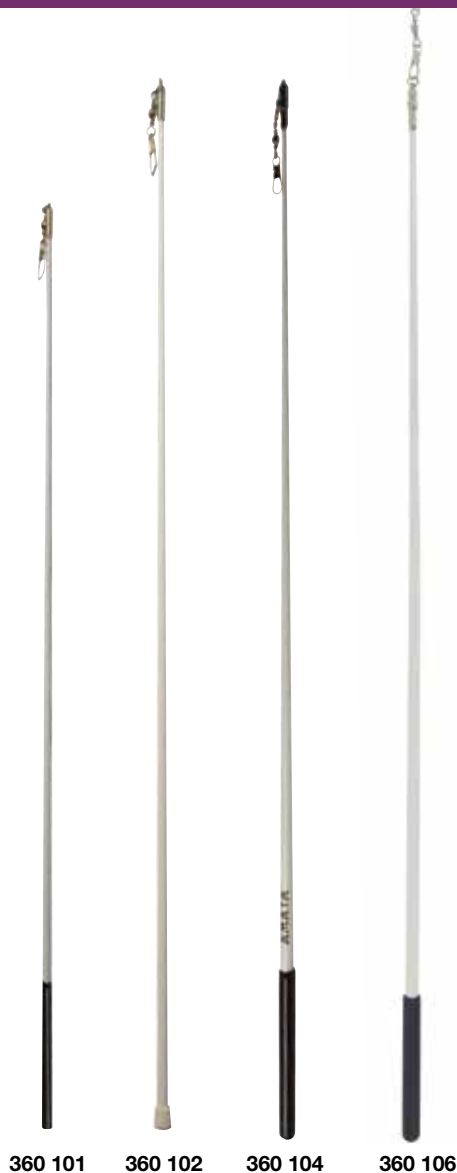

360 101    360 102    360 104    360 106

**360 100 VARILLA FIBRA. 54 CM.  
FIBER STICK. 54 CM.**



**360 102 VARILLA GRAFITO. 60 CM.  
GRAPHITE STICK. 60 CM.**



**360 104 00 VARILLA CON MANGO ANTIDESLIZANTE. BLANCA. 60 CM.  
STICK WITH NONSLIP HANDLE. WHITE. 60 CM.**

Sello FIG impreso. Válidas para competición internacional.  
FIG printed. For international competition



**360 106 VARILLA COMPETICION INTERNACIONAL 60 CM.  
INTERNATIONAL COMPETITION STICK 60 CM.**

Sello FIG impreso. Válidas para competición internacional.  
FIG printed. For international competition



**360 104 VARILLA CON MANGO ANTIDESLIZANTE - COLORES GALAXY - 60 CM. - GALAXY STICK**

- 360 104 14  
Plata / Silver
- 360 104 13  
Negro / Black
- 360 104 10  
Fucsia / Fuchsia
- 360 104 16  
Turquesa / Turquoise
- 360 104 07  
Roja / Red
- 360 104 20  
Oro / Gold

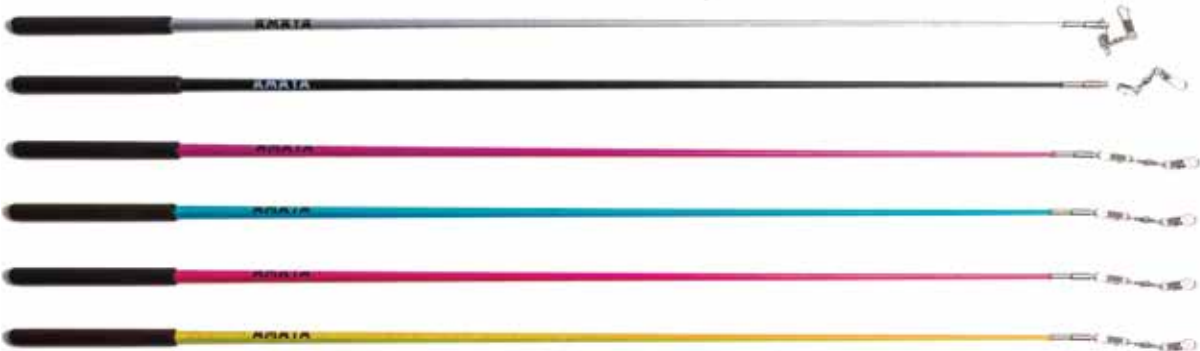

**360 200 CAJA ENROLLACINTAS  
RIBBONS ROLLER**



**360 108 CORDONES UNIÓN CINTA CON VARILLA  
ROPE TO FIX STICK AND RIBBON**

Cordones unión cinta con varilla. Cuerda de nylon y anilla de acero cromado. Longitud: 5cm  
Grosor: 2 mm.





## 360 403 PUNTERA ENTRENAMIENTO TRAINNING GYM SHOE

Puntera entrenamiento. Base cuero especial máxima durabilidad. Cosido exterior.  
*Training gym shoe. Special leather with maximum durability.*



## 360 402 PUNTERA COMPETICIÓN COMPETITION GYM SHOE

Puntera competición. Fabricada en cuero cosido clásico.  
*Competition gym shoe. Classic leather.*



## 360 404 PUNTERA ÉLITE COMPETICIÓN ELITE COMPETITION GYM SHOE

Puntera elite competición. Fabricada en cuero cosido especial para mejor ajuste al pie. Cosido exterior. *Elite competition gym shoe. Special sewn for improving the fit to the foot.*



## 360401 PUNTERA COLEGIOS SCHOOL GYM SHOE

Puntera de cuero. - *Leather shoe*



## RODILLERAS GIMNASIA RÍTMICA RHYTHMIC GYMNASTICS KNEEPADS

Rodilleras fabricadas en lycra elástica suave con doble amortiguación. Super confortables y suaves. Pensadas especialmente para la gimnasia rítmica y deportes que necesitan gran flexibilidad. Tamaño alrededor de la rodilla XS (24-30cm), S (28-34cm), M (32 -38cm), L (36-42cm)

*Kneepads made of soft elastic lycra with double cushioning. Very comfy and soft. Especially designed for Rhythmic Gymnastics and sports that need great flexibility. Size around the knee XS (24-30cm), S (28-34cm), M (32 -38cm), L (36-42cm)*



360 450 Negro



360 452 Verde



360 451 Amarillo



360 453 Fucsia

## 360 455 PROTECTOR ESPALDA GIMNASIA RÍTMICA RHYTHMIC GYMNASTICS BACK PAD

Fabricado en Espuma de Poliuretano de máxima calidad recubierto de microfibra de color negra. Elásticos de poliamida. Medida 27 x 15 x 5 cm.

*Made in Foam de P.U. and covered with black microfiber. Polyamide elastics. Measure 27 x 15 x 5 cm .*



## 900 905 HINCHADOR MANUAL HAND PUMP

Hinchador manual. Fabricado en plástico blando. Fácil manejo. Tiene válvula interior para direccionar el aire. Girando el tornillo se selecciona bien que el aire entre y no salga para hinchar o bien que el aire salga y no entre para deshinchar.

*Hand pump. Made of soft plastic. Easy operation. It has indoor valve to direct the air. Turn the screw for selecting if air enter for inflating or air leaves for deflating.*



# CUERDAS - ROPES

340 301 NUEVAS CUERDAS MULTICOLOR  
NEW MULTICOLOR ROPES

Sello FIG impreso. Válida para competición internacional. / Fig printed. For international competition.



**34030101 CUERDA MULTICOLOR**  
Rosa, fucsia, lila



**34030102 CUERDA MULTICOLOR**  
Blanco, rosa, fucsia



**34030103 CUERDA MULTICOLOR**  
Blanco-lila-morado



**34030104 CUERDA MULTICOLOR**  
Amarillo, naranja, fucsia



**34030105 CUERDA MULTICOLOR**  
Amarillo, verde, blanco.



**34030106 CUERDA MULTICOLOR**  
Celeste-turquesa-azulón

FÉDÉRATION INTERNATIONALE  
DE GYMNASTIQUE



*Certificate*

accorded to / accordé à

**AMAYA SPORT S.L.**

We hereby confirm that the apparatus mentioned below adheres to the FIG norms and may therefore be used at all FIG events, as well as those of its Continental Unions and Affiliated Federations

Nous attestons que les appareils de gymnastique mentionnés ci-dessous répondent aux exigences de la FIG et peuvent être utilisés dans toutes les manifestations de la FIG, ainsi que celles des Unions Continentales et Fédérations Affiliées

**Rope**

**Apparatus ID: 498**

This Certificate is valid until / Ce Certificat est valable jusqu'au

**June 17th, 2023**



Lausanne, June 17th, 2021

FEDERATION INTERNATIONALE  
DE GYMNASTIQUE

Morinari Watanabe  
President

Nicolas Buompane  
Secretary General





## 340 300 CUERDAS COMPETICIÓN 3 M. COMPETITION ROPES 3M.

Cuerda competición de 3m. Nuevo material textil. Nuevo hilo. Brillante de alta tenacidad. Doble trenzado Tandem. Grosor: 9.50 mm. Peso: 172g. Sello FIG impreso. Válidas para competición internacional.

String competition. New fabric. Brilliant high toughness. Tandem double stranded. Thickness: 9.50mm Weight: 172 g\*. FIG printed. For international competition.



**TABLA DE COLORES CUERDAS COMPETICIÓN**  
COMPETITION'S ROPE COLOUR TABLE

**TABLA DE COLORES FLUORESCENTES**  
FLOURESCENT COLOUR TABLE

1	2	3	7	9	10	11	12	13	14	15	16	25	27	26	28
blanco white	rosa claro light pink	amarillo yellow	rojo red	verde rayo ray green	fucsia fuchsia	azulón deep blue	morado purple	negro black	gris grey	lila lilac	turquesa turquoise	amarillo yellow	rosa pink	naranja orange	verde green

## 340 400 CUERDA ENTRENAMIENTO 3 M. TRAINING ROPE 3M.



**TABLA DE COLORES CUERDAS ENTRENAMIENTO**  
TRAINING'S ROPE COLOUR TABLE

1	2	3	5	6	7	8	9	10	11	12	13	15	16	18
blanco white	rosa claro light pink	amarillo yellow	celeste blue sky	verde claro light green	rojo red	naranja orange	verde rayo ray green	fucsia fuchsia	azulón deep blue	morado purple	negro black	lila lilac	turquesa turquoise	pistacho pistachio green

# PELOTAS - BALLS

## Pelota rítmica **TECNOCAUCHO®** - Rhythmic gymnastics ball **TECNOCAUCHO®**

Nueva pelota fabricada artesanalmente en material caucho tecnológico. Capa más externa: barniz antideslizante.

Mejora de prestaciones en cuanto a: Mejor toque - Más blanda y fácil de manejar - Agarre antideslizante - Bote sin vibraciones - Mayor resiliencia y facilidad de recuperación tras la deformación. Peso: 400-410 g. - Diámetro: 180-200 mm. - Válvula hinchable.

*Innovative material created in our AMAYA Sport factory in Spain. It is much more flexible and abrasion-resistant than ordinary rubber providing a high quality end-product. Hand-crafted new Ball Tecno Caucho®. With non-slip coated outer layer.*

*Improved performance: Better Touch - Much softer and easier to handle - Non-slip grip - Bounce without vibrations - Improved flexibility to recover quickly its shape. Weight: 400-410 g. - Diameter: 180-200 mm. - Inflatable valve.*

**TECNOCAUCHO®**

### PELOTA RÍTMICA LISA- RHYTHMIC GYMNASTICBALL SMOOTH

**350 500** Pelota rítmica Tecno Caucho® Ø 190 mm. Sello FIG impreso. Válidas para competición internacional. - Rhythmic gymnasticball Tecno Caucho® Ø 190 mm. FIG printed. For international competition.

**350 550** Pelota rítmica Tecno Caucho® infantil Ø 150 mm. - Children's rhythmic gymnasticball Tecno Caucho® Ø 150 mm.





**TECNOCAUCHO®**

**350 535 PELOTA RÍTMICA GLITTER  
RHYTHMIC GYMNASTICBALL GLITTER**

Sello FIG impreso. Válidas para competición internacional. - FIG printed. For international competition.



**GIMNASIA RÍTMICA - RHYTHMIC GYMNASTIC**

**TECNOCAUCHO®**

**350 507 PELOTA RÍTMICA GLITTER INFANTIL  
CHILDREN'S RHYTHMIC GYMNASTICBALL GLITTER**

**350 536 PELOTA RÍTMICA EFECTO HOLESCENTE  
RHYTHMIC GYMNASTICBALL HOLOSCENT EFFECT**

Sello FIG impreso. Válidas para competición internacional. - FIG printed. For international competition.

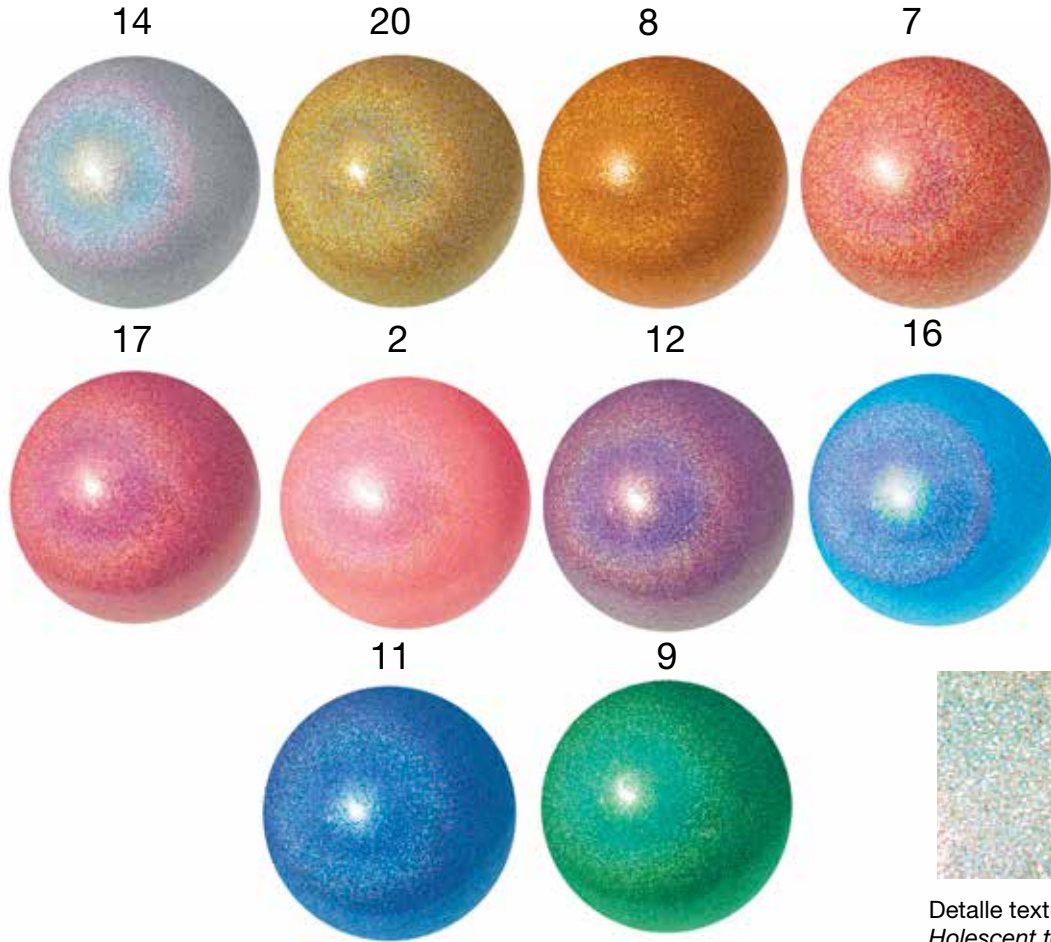

**350 534 PELOTA EFECTO RÍTMICA IRIDISCENTE  
RHYTHMIC GYMNASTICBALL IRIDISCENT EFFECT**

Sello FIG impreso. Válidas para competición internacional. - FIG printed. For international competition.

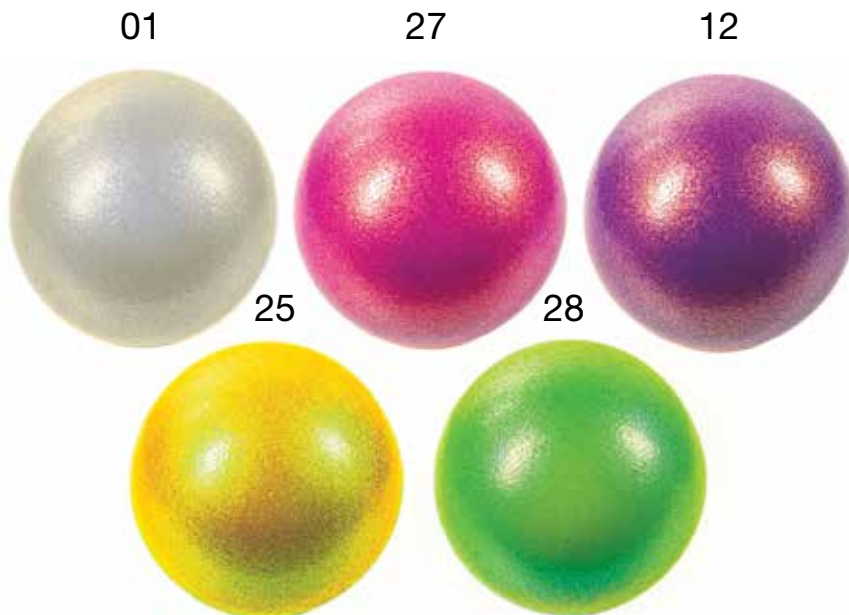

GIMNASIA RÍTMICA - RHYTHMIC GYMNASTIC



## 350 630 PELOTA COMPETICIÓN GALAXY COMPETITION GYMNASTICBALL GALAXY

Pelota competición Galaxy, Ø 180 - 200 mm. Peso: 400 gr. Sello FIG impreso. Válidas para competición internacional.  
Competition Galaxy ball, Ø 180-200 mm., 400 gr. FIG printed. For international competition.



## 350 200 PELOTA COMPETICIÓN MARMOL COMPETITION GYMNASTICBALL MARBLE

Pelota competición marmol, Ø 180 - 200 mm. Peso: 400 gr. Sello FIG impreso. Válidas para competición internacional.  
Elite marble balls, Ø 180-200 mm, 400 gr. FIG printed. For international competition.



## 350 620 PELOTA COMPETICIÓN TRANSPARENTE COMPETITION TRANSPARENT GYMNASTICBALL

Pelota competición transparente, lacada, Ø 180 - 200 mm. Peso: 400 gr. - *Competition transparent ball, Ø 180-200 mm, 400 gr.*



## PELOTAS COMPETICIÓN Y ENTRENAMIENTO NACAR COMPETITION AND TRAINNING LAQUERED NACRED GYMNASTICBALLS

**350 700** Pelota competición lisa lacada, Ø 180 - 200 mm. Peso: 400 gr. Sello FIG impreso. Válida para competición internacional.

*Laquered elite balls, Ø 180-200 mm., 400 gr. Fig printed. For international competition.*

**350 800** Pelota nácar competición lacada, Ø 180 - 200 mm. Peso: 400 gr. Sello FIG impreso. Válida para competición internacional.

*Laquered nacred elite balls, Ø 180-200 mm., 400 gr. Fig printed. For international competition.*

**351 000** Pelota infantil entrenamiento, Ø 160 - 170 mm. Peso: 310 gr. - *Children training balls, not lacquered, Ø 160-170 mm, 310 gr.*

**351 100** Pelota entrenamiento, Ø 180 - 200 mm. Peso: 400 gr. - *Laquered training balls, Ø 180-200 mm.*





# TAPICES - CARPETS

Tapiz de máxima calidad y resistencia. Fabricado en material no abrasivo, pensado para un uso continuado durante años. Con refuerzos en todos los laterales para una mayor durabilidad. Cumplen con todos los requerimientos oficiales para la práctica de Gimnasia Rítmica.

Medidas oficiales de 14 x 14 m. Modelo liso en color Beige. No incluye cinta de delimitación. Fabricado en poliamida bajo el sistema Tufting, con pelo cortado plano Velours. Peso: 1800 gr/m<sup>2</sup>. Muy resistente. Peso del pelo: 730 gr/m<sup>2</sup>. Galga de 1/8". Backing de SB-TR- YUTE sintético. Altura del pelo 6 mm, Altural total 8 mm. Densidad de 190260 pelos /m<sup>2</sup>. Resistente al fuego: Cfl s1.

*Maximum quality and resistance carpet. Made of non-abrasive material, designed for continuous use for years. With reinforcements on all sides for greater durability. They comply with all official requirements for the practice of Rhythmic Gymnastics.*

*Official measurements of 14 x 14 m. Formed by 4 rolls. Of 3,5 m. Plain model in Beige. It does not include delimitation tape. Made of polyamide under the Tufting system, with Velours flat cut hair. Weight: 1800 gr/m<sup>2</sup>. Very resistant. Hair weight: 730 gr/m<sup>2</sup>. 1/8" gauge. Backing of SB-TR-YUTE synthetic. Pile height 6 mm, total height 8 mm. Density of 190260 hairs /m<sup>2</sup>. Fire resistant: Cfl s1.*



**300 501 00** Tapiz Gimnasia Rítmica de competición "Victoria" con GRECA. Tapiz de máxima calidad y resistencia. Fabricado en material no abrasivo, pensado para un uso continuado durante años. Medidas oficiales de 14 x 14 m.

*Maximum quality and resistance carpet. Made of non-abrasive material, designed for continuous use for years. Official measurements of 14 x 14 m.*

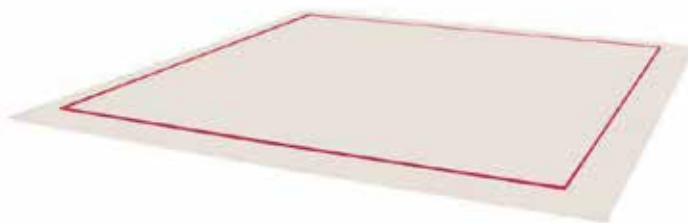

**300 500 00** Tapiz Gimnasia Rítmica de Competición "Victoria" Liso. Tapiz de máxima calidad y resistencia. Fabricado en material no abrasivo, pensado para un uso continuado durante años. Cinta adhesiva roja no incluida. Medidas oficiales de 14 x 14 m.

*Maximum quality and resistance carpet. Made of non-abrasive material, designed for continuous use for years. Adhesive tape not included. Official measurements of 14 x 14 m.*



**300 506 00** Tapiz Gimnasia Rítmica "Club" con GRECA. Tapiz de tacto suave y agradable, pensado para todo tipo de entrenamientos. Un tapiz de gran calidad de material suave y no abrasivo, pensado para un uso continuado durante años. Medidas oficiales de 14 x 14 metros.

*Soft and pleasant to the touch, designed for all types of training. A high quality carpet made of soft and non-abrasive material, designed for years of continuous use. Official measurements of 14 x 14 meters.*



**300 505 00** Tapiz Gimnasia Rítmica "Club" Liso. Tapiz de tacto suave y agradable, pensado para todo tipo de entrenamientos. Un tapiz de gran calidad de material suave al tacto y no abrasivo, pensado para un uso continuado durante años. Cinta adhesiva roja no incluida. Medidas oficiales de 14 x 14 m. Compuesto de 4 rollos de 3,5 metros.

*Soft and pleasant to the touch, designed for all types of training. A high quality, soft-touch, non-abrasive mat, designed for years of continuous use. Official measurements of 14 x 14 m. Composed of 4 rolls of 3.5 meters. Adhesive tape not included.*

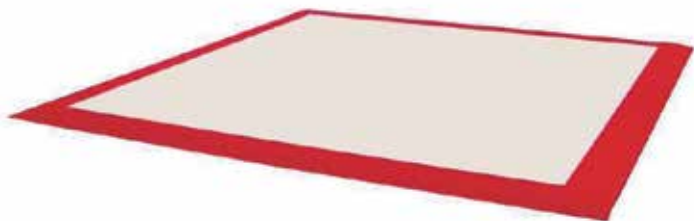

**300 511 00** Tapiz Gimnasia Rítmica "Lite" con GRECA. Pensado para todo tipo de entrenamientos. Un tapiz de gran calidad de material no abrasivo, pensado para un uso continuado durante años. Medidas oficiales de 14 x 14 metros. Formado por 4 rollos. 2 exteriores de 3,75 metros y 2 centrales de 3,25 metros.

*Designed for all types of training. A high quality carpet of non-abrasive material, designed for continuous use for years. Official measurements of 14 x 14 meters. Made up of 4 rolls. 2 exterior rolls of 3.75 meters and 2 central rolls of 3.25 meters.*



**300 510 00** Tapiz Gimnasia Rítmica "Lite" Liso. Pensado para todo tipo de entrenamientos. Un tapiz de gran calidad de material no abrasivo, pensado para un uso continuado durante años. Medidas oficiales de 14 x 14 m. Compuesto de 4 rollos de 3,5 m. Cinta adhesiva roja no incluida.

*Designed for all types of training. A high quality carpet of non-abrasive material, designed for continuous use for years. Official measurements of 14 x 14 m. Composed of 4 rolls of 3.5 m. Adhesive tape not included.*

Barra de ballet portátil. Ligera y de fácil transporte. Para realizar ejercicios de barra, entrenamientos versátiles de fuerza, masajes de piernas, estiramientos de pies etc., es un reforzador de cuerpo total simple y portátil. Ayuda a trabajar los músculos de los brazos, el pecho, la espalda y el centro usando tu propio peso corporal como resistencia. Almohadillas antideslizantes en los pies de la barra. La altura es ajustable para todas las edades. Fabricado en acero acabado epoxi. Barra metálica decoración madera.

*The ballet bar is used to perform bar exercises, versatile strength training, leg massage, feet stretching, etc. It is a simple and portable total body booster. It helps to work out the arms, chest, back and core muscles using your own body weight as resistance. Bushing insertion in nylon and plastic washers to avoid scratches in the bars. Non-slip pads on the feet of the bars. The height is adjustable for all ages.*

## 499 000 BARRA DE BALLET - BALLET BARRE

Longitud: 110 cm. Diámetro barra 38 mm. Altura ajustable. Altura mínima 70 cm y altura máxima 113 cm. Peso barra: 5,7 kg Carga máxima: 136 kg.  
Long 110 cm. Adjustable height. Minimum height 70 cm and maximum height 113 cm. Bar's weight: 5 kg Maximum load: 136 kg Manufactured in powder coated steel.



## 499 001 BARRA DE BALLET DOBLE - DOUBLE BALLET BARRE

Longitud: 2 barras de 110 cm. Diámetro barra 38 mm. Altura ajustable. Altura mínima 70 cm y altura máxima 113 cm. Peso barra: 6,3 kg. Carga máxima: 136 kg.  
Long 2 bars of 110 cm. Adjustable height. Minimum height 70 cm and maximum height 113 cm. Bar's weight: 6,3 kg Maximum load: 136 kg Manufactured in powder coated steel.





**499 002 BARRA DE BALLET DOBLE GRUPAL - DOUBLE GROUPAL BALLET BARRE**

Longitud: 2 barras de 230 cm. Diámetro barra 38 mm. Altura ajustable. Altura mínima 70 cm y altura máxima 113 cm. Peso barra: 10 kg Carga máxima: 250 kg.  
 Long 110 cm. Adjustable height. Minimum height 70 cm and maximum height 113 cm. Bar's weight: 10 kg Maximum load: 250 kg Manufactured in powder coated steel.

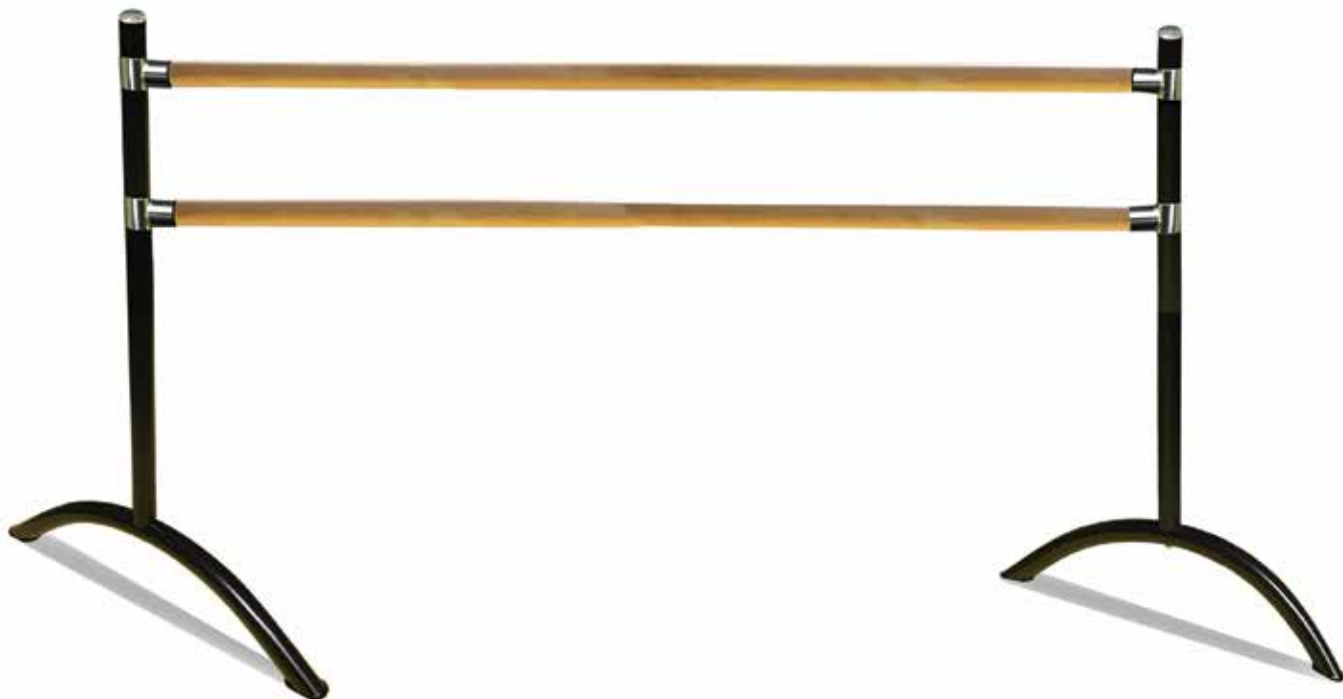

BALLET

**499 010 BANDA ESTIRAMIENTOS AJUSTABLE - ADJUSTABLE STRECH BAND**

Banda ajustable para estiramientos. Medidas: Correas de algodón: 2 correas de 96 x 3,8 cm Correa elástica: 65 x 7,5 cm Cubierta de neopreno: 54 x 9 cm.

- Desarrolla la potencia y fuerza muscular.
- Proporciona soporte y estiramiento, todo en una banda.
- Para uso en estiramientos de cuerpo completo (como por ejemplo un arabesco de ballet) y también puede ser ajustado a las partes más específicas y pequeñas del cuerpo (como hombros o isquiotibiales).
- Lazos ajustables mediante hebillas de metal para usar con diferentes niveles de resistencia y flexibilidad.
- Mejora de la flexibilidad y profundización del estiramiento.
- El elástico cuenta con una cómoda cubierta de neopreno para proteger zonas como por ejemplo, los hombros.

*Elastic band adjustable to the body for stretching. Dimensions: Cotton straps: 2 straps of 96 x 3.8 cm Elastic strap: 65 x 7.5 cm Neoprene cover: 54 x 9 cm*

- *Develop muscle power and strength.*
- *Provides support and stretch all in one band.*
- *Suitable for full body stretching (such as a ballet arabesque) but also adjustable to stretch specific parts the of the body (such as shoulders or hamstrings).*
- *Adjustable loops through metal buckles to use with different levels of strength and flexibility.*
- *Improves flexibility and deepening of the stretch.*
- *The elastic has a comfortable neoprene cover to protect areas such as shoulders.*



BALLET



# TURNING BOARD

## 640 926 TURNING BOARD

El Turning Board es la herramienta de entrenamiento preferida por los bailarines que desean mejorar sus giros. Perfecto para encontrar el centro de gravedad permanente.

Mejora tus giros y aumenta tu confianza. El giro correcto del ballet requiere una localización centrada, un core fuerte y una colocación correcta de las extremidades.

Experimenta la sensación de hacer giros adicionales y gana confianza a medida que mejoran tus giros. Gira mejor con el Turning Board.

Medidas: Longitud: 28 cm de largo x 7,5 cm de ancho.

*The Turning Board is the best tool for dancers looking to improve their techniques. It allows dancers to find their permanent centre of gravity, improving their confidence and performances. The perfect turn requires a centered location, a strong core and a suitable placing of the extremities. All this skills can be acquired with the Turning Board and you will experience the feeling of increasing and improving your turns. Dimensions: 28 cm long x 7,5 cm wide*





**300 050** Espaldera simple.

Espaldera fabricada en madera de haya de gran calidad. Largueros de 13 cm. de fondo x 33 mm. de grosor, con cantos redondeados. Barras ovaladas según normativa. Toda la madera tratada con barniz no tóxico de color natural. Medidas de 2,6 m x 1 m. 16 peldaños. Anclajes incluidos. Acorde a la normativa EN12346.

*Simple Wall bar.*

*Made in high quality Bot ash tree wood.*

*Crossbeams 13 cm. depth x 33 mm. thickness, with rounded edges. Oval bars as the normative required. The wood is threated with a non toxic varnish in natural colour. Meassure: 2,6 m x 1 m. 16 bars. Acording with the form EN12346.*



**300 055** Espaldera doble.

Espaldera fabricada en madera de haya de gran calidad. Largueros de 13 cm. de fondo x 33 mm. de grosor, con cantos redondeados. Barras ovaladas según normativa. Toda la madera tratada con barniz no tóxico de color natural. Medidas de 2,6 m x 2 m. 16 peldaños. Anclajes incluidos. Acorde a la normativa EN12346.

*Double Wall bar.*

*Made in high quality Bot ash tree wood.. Crossbeams 13 cm. depth*

*x 33 mm. thickness, with rounded edges. Oval bars as the normative required. The wood is threated with a non toxic varnish in natural colour. Meassure: 2,6 m x 2 m. 16 bars. Acording with the form EN12346.*



**300 060** Espaldera funcional metálica simple. Barras recubiertas de caucho acolchado para mejorar el agarre. Medidas 2.6 x 1 m. 18 barras. Anclajes incluidos. Acorde a la normativa EN12346.

*Metallic wallbar. Bars coated with rubber for improving the grip. Measures 2.6 x 1 m. 18 bars. Anchors included. According to Norm EN12346.*





Medicinales fabricados en caucho. Diferentes medidas dependiendo de su peso. Con válvula para regular el aire interior y graduar el bote necesario para cada usuario. Superficie rugosa para máximo agarre, tipo neumático.

*Medicinal made of rubber. Different measures depending on your weight. With valve to regulate the indoor air and adjust the necessary bounce for each user. Rough surface for maximum grip, pneumatic type.*

- 55010400 Medicinal caucho high grip 1 Kg. Ø 190 mm. - High grip medicine ball rubber coloured 1 K. Ø 190 mm.
- 55020400 Medicinal caucho high grip 2 Kg. Ø 190 mm. - High grip medicine ball rubber coloured 2 K. Ø 190 mm.
- 55030400 Medicinal caucho high grip 3 Kg. Ø 230 mm. - High grip medicine ball rubber coloured 3 K. Ø 230 mm.
- 55040400 Medicinal caucho high grip 4 Kg. Ø 230 mm. - High grip medicine ball rubber coloured 4 K. Ø 230 mm.
- 55050400 Medicinal caucho high grip 5 Kg. Ø 230 mm. - High grip medicine ball rubber coloured 5 K. Ø 230 mm.
- 55050500 Medicinal caucho high grip 6 Kg. Ø 286 mm. - High grip medicine ball rubber coloured 6 K. Ø 286 mm.
- 55050600 Medicinal caucho high grip 7 Kg. Ø 286 mm. - High grip medicine ball rubber coloured 7 K. Ø 286 mm.
- 55050700 Medicinal caucho high grip 8 Kg. Ø 286 mm. - High grip medicine ball rubber coloured 8 K. Ø 286 mm.
- 55050800 Medicinal caucho high grip 9 Kg. Ø 286 mm. - High grip medicine ball rubber coloured 9 K. Ø 286 mm.
- 55050900 Medicinal caucho high grip 10 Kg. Ø 286 mm. - High grip medicine ball rubber coloured 10 K. Ø 286 mm.



**MEDICINAL TECNOCAUCHO - TECHNORUBBER MEDICINE BALL**

Balones medicinales de última generación. Inflables, tu regulas el bote dependiendo del aire que tenga el balón. Con un agarre superior al de otros medicinales. Fabricado en una sola pieza por rotomoldeo.

*Made in one single piece via rotomoulding. You regulate the rebound depending of the inflation.*

- 550 050 Medicinal Tecno Caucho color 1 Kg. - Medicine ball Techno rubber coloured 1 K.
- 550 051 Medicinal Tecno Caucho color 2 Kg. - Medicine ball Techno rubber coloured 2 K.
- 550 052 Medicinal Tecno Caucho color 3 Kg. - Medicine ball Techno rubber coloured 3 K.
- 550 053 Medicinal Tecno Caucho color 4 Kg. - Medicine ball Techno rubber coloured 4 K.
- 550 054 Medicinal Tecno Caucho color 5 Kg. - Medicine ball Techno rubber coloured 5 K.



- 550 101 Medicinal con bote 1 kg. (rojo). Ø 185 mm.- *Medicine ball with rebound 1 kg., red.*
- 550 201 Medicinal con bote 2 kg. (rojo). Ø 205 mm.- *Medicine ball with rebound 2 kg., red.*
- 550 301 Medicinal con bote 3 kg. (rojo). Ø 235 mm.- *Medicine ball with rebound 3 kg., red.*
- 550 401 Medicinal con bote 4 kg. (rojo). Ø 241 mm.- *Medicine ball with rebound 4 kg., red.*
- 550 501 Medicinal con bote 5 kg. (rojo). Ø 277 mm.- *Medicine ball with rebound 5 kg., red.*



- 550 100 Medicinal sin bote 1 kg. (verde). Ø 185 mm. - *Medicine ball without rebound 1 kg., green.*
- 550 200 Medicinal sin bote 2 kg. (verde). Ø 205 mm.- *Medicine ball without rebound 2 kg., green.*
- 550 300 Medicinal sin bote 3 kg. (verde). Ø 235 mm.- *Medicine ball without rebound 3 kg., green.*
- 550 400 Medicinal sin bote 4 kg. (verde). Ø 241 mm.- *Medicine ball without rebound 4 kg., green.*
- 550 500 Medicinal sin bote 5 kg. (verde). Ø 277 mm.- *Medicine ball without rebound 5 kg., green.*



- 55010500 Balón Medicinal Reciclado 1 Kg.
- 55020500 Balón Medicinal Reciclado 2 Kg.
- 55030500 Balón Medicinal Reciclado 3 Kg.
- 55040500 Balón Medicinal Reciclado 4 Kg.
- 55050500 Balón Medicinal Reciclado 5 Kg..





**530 510** Disco masaje relax- Massage relax seat 34cm

Tiene válvula hinchable. Se puede controlar la dificultad del ejercicio hinchándolo con más aire para crear mayor inestabilidad.

*Massage relax seat 34cm. With inflatable valve. The most you inflate the article the harder is working as the balance is more difficult.*



**530 511** Discos de equilibrio. Ø 26 cm. - Balance disk Ø 26 cm.



**610 070** Pica madera de haya encerada de 120 cm. Ø 30 mm.  
*Waxing beech wood stick. Length: 120cm. Ø 30mm.*



**610 017** Balance board 40 cm.



### 300 201 00 Trampolín OPEN-END

Fabricado en tubo elíptico plano 65x35x3 mm de acero al carbono de alta calidad, con alta resistencia general dándole máxima seguridad. Equipado con base antideslizante. La superficie de la red está hecha de un cinturón trenzado de nylon, equipado con un resorte elástico de alta resistencia. Ambos lados están equipados con una cuerda elástica de nylon, buena elasticidad general, alta estabilidad. La superficie del equipo se trata mediante un proceso de recubrimiento electrostático y el ajuste de altura se fija mediante tornillos desmontables para garantizar la flexibilidad y seguridad del proceso de elevación.

Tamaño exterior (largo x ancho): 123 cm x 126 cm x (lado inferior (32,6 cm-38,5 cm); lado alto (63,5 cm-72,1 cm);

Tamaño de los materiales de nailon: 70 cm x 63 cm;

Peso neto: 35 kg;

Tamaño del embalaje: 136 cm x 136 cm x 30 cm

#### OPEN-END trampoline

Made of flat elliptical tube /65x35x3mm high quality carbon steel welded, with high overall strength and safety performance, equipped with floor protection foot, which can effectively reduce the damage to the site. Net surface is made of nylon braided belt, equipped with high strength stretch spring, both sides are equipped with high elasticity nylon elastic rope, the overall good elasticity, high stability. The surface of the equipment is treated by electrostatic coating process, and the height adjustment is fixed by detachable screws to ensure the flexibility and safety of the lifting process. Outer Size (length x width): 123 x 126 cm x (Low side (32.6 cm - 38.5 cm) ; High side (63.5 cm - 72.1 cm);

Size of the Nylon Materials: 70 x 63 cm;

Net weight: 35 kg;

Packing Size: 136 x 136 x 30 cm.



300 200 Trampolín elástico 110 x 110 cm.

Elastic trampoline 110 x 110 cm.



609 945 Jump fitness tramp. Ø exterior: 95 cm. Ø interior: 70 cm. Altura: 33 cm.

Fácil de apilar.

Jump fitness tramp. Diameter: 95cm. Interior Diameter: 70cm. Height:

33cm, Easy to stack,



## PELOTAS PINCHOS DE TERMOPLÁSTICO - THERMOPLASTIC SENSO BALLS

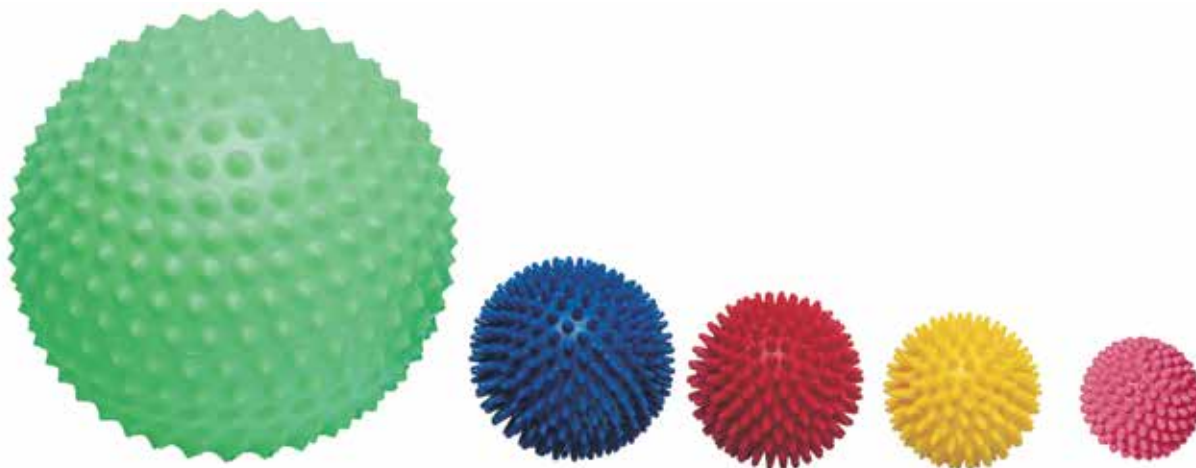

- 530 100 Pelota de pinchos, Ø 75 mm. - Senso ball Ø 75 mm.
- 530 200 Pelota de pinchos, Ø 85 mm. - Senso ball Ø 85 mm.
- 530 300 Pelota de pinchos, Ø 100 mm. - Senso ball Ø 100 mm.
- 530 400 Pelota de pinchos, Ø 220 mm. - Senso ball Ø 220 mm.
- 530 000 Pelota sensorial Ø 65 mm. erizo pico corto. - Hedgehog ball Ø 65 mm., short point.

## ANTI-ESTRÉS DE P.U. - P.U. ANTI-STRESS



Anti-Stress.

- 800 435 Pelota Ø 60 mm. - Ball Ø 60 mm.
- 800 436 Pelota Ø 70 mm. - Ball Ø 70 mm.



- 530 805 Pelotas anti-estres gell ball.  
Anti-stress ball "Gell ball"

## CACAHUETE REHABILITACIÓN DE PU - P.U. REHABILITATION PEANUT



- 530 600 Cacahuete rehabilitación manos azul blando. - Rehabilitation peanut. Blue "Soft".
- 530 700 Cacahuete rehabilitación manos rojo medio. - Rehabilitation peanut. Red "Regular".
- 530 800 Cacahuete rehabilitación manos verde fuerte. - Rehabilitation peanut. Green "Strong".

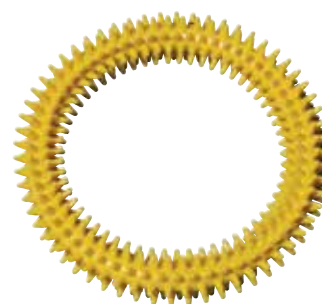

- 530 500 Aro de pinchos, Ø 160 mm.  
Sensorial hoop hedgehog Ø 160 mm.



- 340 300 Cuerda de 3 m. Especial para estiramientos. - Competition rope 3 m. Special for stretching.



- 530 520 Almohadilla cervical y lumbar de termoplástico - Thermoplastic neck and lumbar pillow.

## Colchoneta Tecno Caucho®

185 x 60 x 1 cm. Ofrece unas características muy superiores al caucho normal, proporcionando al producto final una mayor elasticidad y resistencia a la abrasión.

Tecno Caucho® rubber mat 180 x 58 x 1 cm. Tecno Caucho®. It is much more flexible and abrasion-resistant than ordinary rubber providing a high quality end-product.

610 084 07 Roja / Red

610 084 11 Azul / Blue

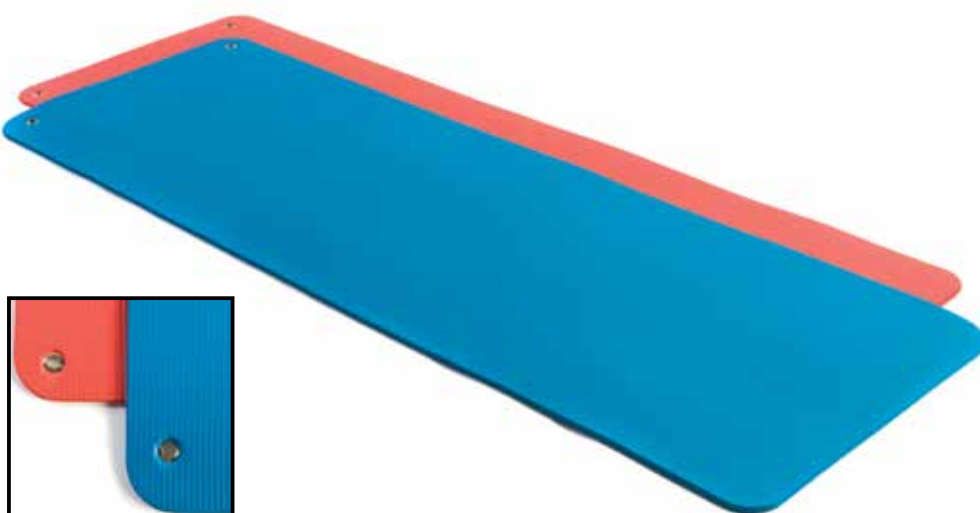

## Colchoneta caucho. 180 x 58 x 1 cm.

Colchoneta de célula cerrada. Ecológica. No absorbe líquidos. Protección antibacterias, antideslizante. Excelente para hidroterapia. Cálido y confortable al tacto.

Rubber mat 180 x 58 x 1 cm. Closed cell mat. Ecologic. Non liquid absorption, antibacterial activity. Non slip surface. Excellent for hydrotherapy. Warm and comfortable.

610 085 10 Fucsia / Fuchsia

610 085 06 Verde / Green

610 085 11 Azul / Blue

610 085 14 Gris / Grey

## 610 086 Colchoneta caucho. 140 x 58 x 1 cm.

Colores: fucsia, verde, azul y gris.

Rubber mat 140 x 58 x 1 cm.

Colors: fuchsia, green, blue and grey.



610 086 10 Fucsia / Fuchsia

610 086 06 Verde / Green

610 086 11 Azul / Blue

610 086 14 Gris / Grey



## 610 087

Colchoneta T.P.E. 180 x 58 x 1,8 cm.

Colchoneta de célula cerrada. Ecológica. No absorbe líquidos.

Protección antibacterias, antideslizante. Fabricada en un nuevo material muy agradable al tacto y suave. Máxima amortiguación.

T.P.E. Mat 180 x 58 x 1,8 cm. Closed cell mat. Ecologic. Non liquid absorption, antibacterial activity. Non slip surface. Excellent for hydrotherapy. Warm and comfortable. The softest touch.







Colchoneta yoga eco-friendly. 180 x 60 x 0,6 cm.  
Yoga's mat eco-friendly 180 x 60 x 0,6 cm.

- 61008306 - Verde - Green
- 61008312 - Morada - Purple
- 61008310 - Fucsia - Fuchsia
- 61008311 - Azul - Blue
- 61008313 - Negra - Black



## ESTERILLA YOGA T.P.E. BICOLOR - TWO-TONE T.P.E. YOGA MAT

Esterilla ecofriendly de doble color. Medidas 183 x 61 cm. Grosor de 6 mm. Peso:1 kg. Antideslizante, muy elástica y confortable. Con diseño grabado de Mandalas.

TPE foam eco-friendly mat. Dimensions: 183 x 61 cm. 6 mm thick. Weight: 1 kg. Anti-slip, very elastic and comfy mat. Nice design with Mandala pattern.

- 50000006 - Verde - Green
- 50000010 - Fucsia - Fuchsia
- 50000011 - Azul - Blue
- 50000007 - Rojo - Red
- 50000013 - Negro - Black
- 50000032 - Aguamarina - Ocean

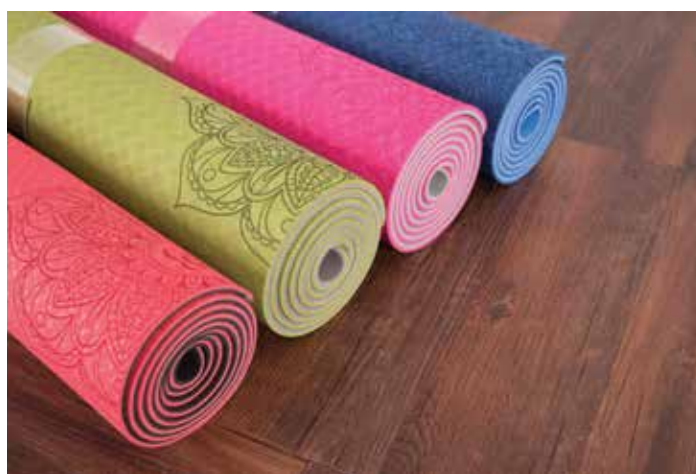

COLCHONETAS - MATS



610 014 Estantería para colchonetas doble. Alto: 198 cm. Ancho: 56 cm. Fondo: 60 cm.  
Double mat rack. 198 cm high, 56 cm. width, 60 cm depth.



610 015 Barras de pared para colchonetas. Medidas: soporte 10 x 5 cm. Barra 25 cm. x Ø 12 mm.  
Wall hook for mat. Meassures: support 10 x 5 cm. Bar 25 cm. x Ø 12 mm.

**COLCHONETA BASIC**



REF.	PRODUCTO - PRODUCT	DENSIDAD - DENSITY
608 976	Colchoneta basic / Basic mat 200 x100 x 5 cm.	25 Kg / m3
608 977	Colchoneta basic / Basic mat 200 x100 x 5 cm.	30 Kg / m3
608 978	Colchoneta basic / Basic mat 200 x100 x 5 cm.	80 Kg / m3
608 980	Colchoneta basic / Basic mat 200 x100 x 10 cm.	20 Kg / m3
608 981	Colchoneta basic / Basic mat 200 x100 x 10 cm.	25 Kg / m3
608 982	Colchoneta basic / Basic mat 200 x100 x 10 cm.	30 Kg / m3

REF.	PRODUCTO - PRODUCT
608 975	Funda de repuesto para colchoneta basic / Cover for basic mat 200 x 100 x 5 cm.
608 979	Funda de repuesto para colchoneta basic / Cover for basic mat 200 x 100 x 10 cm.



REF.	PRODUCTO - PRODUCT	DENSIDAD - DENSITY
608 987	Colchoneta basic infantil / Children Basic mat 160 x 60 x 5 cm.	20 Kg / m3
608 988	Colchoneta basic infantil / ChildrenBasic mat 160 x 60 x 5 cm.	25 Kg / m3

REF.	PRODUCTO - PRODUCT
608 986	Funda de repuesto para colchoneta basic infantil / Cover for children basic mat 160 x 60 x 5 cm.

**COLCHONETAS - MATS**



**QUITAMIEDOS BASIC**



**COLCHONETAS - MATS**

REF.	PRODUCTO - PRODUCT	DENSIDAD - DENSITY
608 990	Quitamiedos basic / Basic Gymnastic mat 300 x 200 x 20 cm.	20 Kg / m3
608 991	Quitamiedos basic / Basic Gymnastic mat 300 x 200 x 20 cm.	25 Kg / m3
608 993	Quitamiedos basic / Basic Gymnastic mat 300 x 200 x 30 cm.	20 Kg / m3
608 994	Quitamiedos basic / Basic Gymnastic mat 300 x 200 x 30 cm.	25 Kg / m3
608 996	Quitamiedos basic / Basic Gymnastic mat 300 x 200 x 40 cm.	20 Kg / m3
608 997	Quitamiedos basic / Basic Gymnastic mat 300 x 200 x 40 cm.	25 Kg / m3

REF.	PRODUCTO - PRODUCT
608 989	Funda de repuesto para quitamiedos basic / Cover for basic gymnastic mat 300 x 200 x 20 cm.
608 992	Funda de repuesto para quitamiedos basic / Cover for basic gymnastic mat 300 x 200 x 30 cm.
608 995	Funda de repuesto para quitamiedos basic / Cover for basic gymnastic mat 300 x 200 x 40 cm.

## COLCHONETA - MAT

Cubierta fabricada en PVC de gran resistencia ignífuga B1/M2. Colchoneta con doble cosido interior, cantoneras de refuerzo y asas para el transporte. Material extra resistente.

Cremallera para su fácil apertura e intercambio del foam. Rejillas para descompresión.

*Cover made of high resistant PVC. Fire proof B1/M2*

*Double sewed gymnastic mat with reinforcements in corners. Handles for transporting. Very resistant material.*

*Contains zip for changing inside foam . Contains grilles for descompresion.*



REF.	PRODUCTO -	DENSIDAD -
609 001	Colchoneta 200 x 100 x 5 cm.	25 Kg / m3
609 002	Colchoneta 200 x 100 x 5 cm.	30 Kg / m3
609 003	Colchoneta 200 x 100 x 5 cm.	80 Kg / m3
609 009	Colchoneta 200 x 100 x 10 cm.	20 Kg / m3
609 010	Colchoneta 200 x 100 x 10 cm.	25 Kg / m3
609 011	Colchoneta 200 x 100 x 10 cm.	30 Kg / m3
609 017	Colchoneta 200 x 100 x 20 cm.	20 Kg / m3
609 018	Colchoneta 200 x 100 x 20 cm.	25 Kg / m3
609 025	Colchoneta 200 x 150 x 5 cm.	25 Kg / m3
609 026	Colchoneta 200 x 150 x 5 cm.	30 Kg / m3
609 027	Colchoneta 200 x 150 x 5 cm.	80 Kg / m3
609 033	Colchoneta 200 x 150 x 10 cm.	20 Kg / m3
609 034	Colchoneta 200 x 150 x 10 cm.	25 Kg / m3
609 035	Colchoneta 200 x 150 x 10 cm.	30 Kg / m3
609 041	Colchoneta 200 x 150 x 20 cm.	20 Kg / m3
609 042	Colchoneta 200 x 150 x 20 cm.	25 Kg / m3
609 043	Colchoneta 200 x 150 x 20 cm.	30 Kg / m3

REF.	PRODUCTO -
609 000	Funda para colchoneta 200 x 100 x 5 cm.
609 008	Funda para colchoneta 200 x 100 x 10 cm.
609 016	Funda para colchoneta 200 x 100 x 20 cm.
609 024	Funda para colchoneta 200 x 150 x 5 cm.
609 032	Funda para colchoneta 200 x 150 x 10 cm.
609 040	Funda para colchoneta 200 x 150 x 20 cm.



## QUITAMIEDOS

Quitamiedos con doble cosido, cantoneras de refuerzo y asas para el transporte.

Material extra resistente. Cremallera para su fácil apertura e intercambio.

Rejillas para descompresión. También plegables en dos piezas.

*Double sewed gymnastic mats with reinforcements in corners and handles for the transport. Very resistant material. Contains grilles for descompresion and zip for changing inside. Possible folded in two pieces.*



REF.	PRODUCTO - PRODUCT	DENSIDAD - DENSITY
609 101	Quitamiedos / Gimnastic mat 300 x 200 x 20 cm.	20 Kg / m3
609 103	Quitamiedos / Gimnastic mat 300 x 200 x 20 cm.	25 Kg / m3
609 109	Quitamiedos / Gimnastic mat 300 x 200 x 30 cm.	20 Kg / m3
609 111	Quitamiedos / Gimnastic mat 300 x 200 x 30 cm.	25 Kg / m3
609 117	Quitamiedos / Gimnastic mat 300 x 200 x 40 cm.	20 Kg / m3
609 119	Quitamiedos / Gimnastic mat 300 x 200 x 40 cm.	25 Kg / m3
609 125	Quitamiedos / Gimnastic mat 300 x 200 x 50 cm.	20 Kg / m3

REF.	PRODUCTO - PRODUCT
609 100	Funda para quitamiedos / Cover for gymnastic mat 300 x 200 x 20 cm.
609 108	Funda para quitamiedos / Cover for gymnastic mat 300 x 200 x 30 cm.
609 116	Funda para quitamiedos / Cover for gymnastic mat 300 x 200 x 40 cm.
609 124	Funda para quitamiedos / Cover for gymnastic mat 300 x 200 x 50 cm.



REF.	PRODUCTO -	DENSIDAD -
609 133	Quitamiedos plegable en 2 piezas / Foldable gymnastic mat in 2 pieces 300 x 200 x 20 cm.	20 Kg / m3
609 135	Quitamiedos plegable en 2 piezas / Foldable gymnastic mat in 2 pieces 300 x 200 x 20 cm.	25 Kg / m3
609 141	Quitamiedos plegable en 2 piezas / Foldable gymnastic mat in 2 pieces 300 x 200 x 40 cm.	20 Kg / m3
609 143	Quitamiedos plegable en 2 piezas / Foldable gymnastic mat in 2 pieces 300 x 200 x 40 cm.	25 Kg / m3
609 132	Funda para quitamiedos plegable 300 x 200 x 20 cm. / Cover for foldable mat 300 x 200 x 20 cm.	
609 140	Funda para quitamiedos plegable 300 x 200 x 40 cm. / Cover for foldable mat 300 x 200 x 40 cm.	



REF.	PRODUCTO -	DENSIDAD -
609 081	Colchoneta infantil 160 x 60 x 5 cm. - Children mat 160x60x5cm.	20 Kg / m3
609 082	Colchoneta infantil 160 x 60 x 5 cm. - Children mat 160x60x5cm.	25 Kg / m3

REF.	PRODUCTO - PRODUCT
609 080	Funda para colchoneta infantil de 160 x 60 x 5 cm. - Cover for children mat.





**900895** Carro Porta-Colchonetas 2000 x 1000 mm.

Fabricado con acero tratado para la corrosión. 4 ruedas de PU, 2 fijas y 2 giratorias. Medidas de 2000 mm x 1000 mm. Plegable. Peso máximo recomendado 250 Kg.

*Trolley for Mats 2000 x 1000 mm. Made of steel treated for corrosion. 4 PU wheels (2 fixed and 2 gyrotory). Measures 2000 mm x 1000 mm. Foldable. Maximum weight recommended 250 kg.*

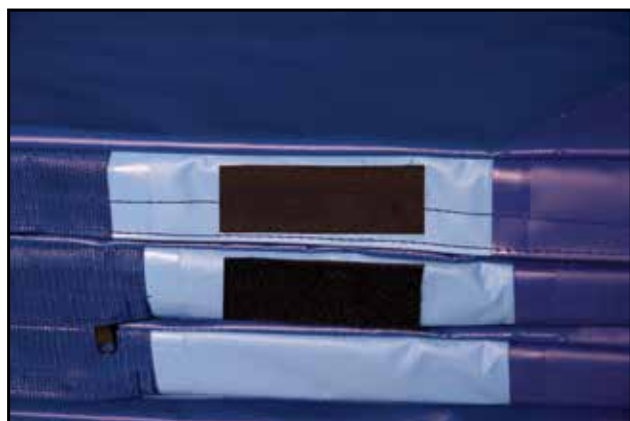

**609152** SET VELCRO

Conjunto de 10 velcros autoadhesivos de 10 cm x 4 cm. Ideales para la unión de nuestras piezas de foam o colchonetas, para la realización de circuitos o áreas de gimnasia.

*Set of 10 self-adhesive velcro 10 cm x 4 cm. Ideal for joining our pieces of foam or mats, for making circuits.*



**609 150** Set de 6 pegatinas antideslizantes para colchonetas y figuras de foam. Medidas: 180 x 130 mm.

*Set of 6 nonslip stickers for mats and foam figures.*

## AIR MATS

Air mats pensadas para usarse como pistas acrobáticas de aire, y colchonetas hinchables tanto para principiantes como para atletas avanzados. Sin costuras, las diferentes piezas van termo soldadas, ofreciendo una resistencia superior.

*Air mats designed to be used as acrobatic airstrips and inflatable mats for both beginners and advanced athletes. Without seams, the different pieces go thermo welded, offering superior resistance.*

- Dureza ajustable gracias a la regulación de la presión de aire interior. - *Adjustable hardness with a pressure regulator for inside air.*
- Pueden unirse varias colchonetas entre sí gracias a los velcros de los laterales. - *It's possible to join some mats with the side velcros.*
- Rebote de alta resiliencia. - *High resilience rebound.*
- Asas en ambos lados, para facilitar su transporte. - *Handles in both sides, to ease the transport.*
- Incluye hinchador eléctrico para un fácil y rápido hinchado. - *Includes an electric pump for a quick and easy inflation.*
- Incluye bolsa para su fácil almacenamiento y transporte. - *Includes a bag for a nice storage and transport.*
- Incluye kit de reparación. - *Includes repair kit.*



- 60890000 AIR MAT 3 x 1 x 0.1 m.
- 60890100 AIR MAT 3 x 2 x 0.2 m.
- 60890200 AIR MAT 6 x 2 x 0.2 m.
- 60890300 AIR MAT 8 x 2 x 0.2 m.
- 60890400 AIR MAT 10 x 2 x 0.2 m.
- 60890500 AIR MAT 12 x 2 x 0.2 m.

### 608 920 00 AIR BLOCK - 608 915 00 AIR BOX

Los Air Block y Air Box son perfectos para diferentes ejercicios de acondicionamiento y equilibrio, así como para practicar habilidades como handstand downs, stand back tops, back handsprings, back flips, aéreos, etc... Son pequeños y ligeros lo que los hace muy fáciles de empaquetar y llevar a cualquier parte. Son más gruesas que las colchonetas de aire, por lo que brindan una superficie elevada que les permite a las gimnastas una mejor plataforma para muchos movimientos. Puede ser utilizado en cualquier superficie, en interiores o exteriores, por niños y adultos, aficionados y profesionales. Medidas Air Block: 2 x 0,9 x 0,2 m. Medidas Air Box: 2 x 1,4 x 0,2 m.

*Air blocks and Air Box are perfect for different conditioning and balance exercises, as well as for practicing skills such as handstand snap downs, standing back tops, back handsprings, back flips, aerials, etc... They are smaller and lighter than air tracks, which makes them very easy to pack and take anywhere. They are thicker than air mats, so they provide a raised surface that allows gymnasts a better platform for many moves. Can be used on any surface, indoors or outdoors, by kids and adults, amateurs and professionals. Measure Air Block: 2 x 0,9 x 0,2 m. Measure Air Box: 2 x 1,4 x 0,2 m.*

### 608 910 00 AIR BARREL

La herramienta perfecta para entrenar volteretas, volteretas hacia atrás, gimnasia, yoga, artes marciales, programas de terapia, etc. FÁCIL DE USAR. Se puede inflar o desinflar en tan solo 1 minuto. FÁCIL DE TRANSPORTAR. Se puede plegar y desplegar rápidamente. Después del inflado, no hay ruido al entrenar y mantendrá su presión durante días. Medidas: Ø1,2 X 2 m.

*To train tumbling, back handspring, gymnastics, yoga, martial arts, therapy programs etc. EASY TO USE. The air block can be inflated or deflated in just 1 minute. EASY TO CARRY. Can be fold and unfold quickly. After inflation, there is no noise when training and will maintain its pressure for days. Measure: Ø1,2 X 2 m.*







**900 860** Cinta métrica 15 m.  
*Metric tape 15 m.*



**900 862** Cinta métrica 50 m.  
*Metric tape 50 m.*



**900 870** Megáfono. Potencia 25 W. No incluye baterías.  
*Megaphone. Power 25 W. No batteries included.*



**900 863** Cinta métrica 30 m.  
*Metric tape 30 m.*



**BANCO SUECO**

Medidas 2 y 3 metros de largo. Fabricado totalmente en madera de haya de gran calidad. TAPA Largo: 2000 - 3000 mm, Ancho: 220 mm., Grosor: 35mm. PATAS Con base de goma para evitar deslizamientos y desperfectos en el pavimento. Altura: 260 mm., Base: 320 mm., Grosor : 40 mm. Con barra inferior de 1800mm. de largo por 100 de ancho y 35mm de grosor. Todas las piezas sujetas mediante cola y ángulos metálicos tratados para la corrosión. Toda la madera tratada con barniz no tóxico de color natural. Todas las esquinas y aristas redondeadas con un radio de 2mm.

*Gymnastic bench. Made in high quality Beech tree Wood. Length: 2000 - 3000 mm, width: 220 mm. thickness: 35mm.*

*Legs with rubber base. High: 260 mm. base: 320 mm. thickness : 40 mm. With a down bar of 1800 mm. long x 100 wide x 35 mm thickness. The wood is thrated with a non toxic varnish in natural colour. Round corners 2mm. ratio.*

**300 000** banco sueco. Longitud 2 m. - *Gimnastic bench. Length 2 m.*

**300 005** banco sueco. Longitud 3 m. - *Sweden bench. Length 3 m.*



**900 894** Carro estantería 16 balones.  
Medidas: 100 x 160 cm.  
Cart 16 balls. Measure: 100 x 160 cm.



**900 890** Carro almacenamiento de lona.  
Medidas: 75 x 75 x 60 cm.  
Storage canvas cart. Measure: 75 x 75 x 60 cm.



**900 891** Carro almacenamiento 118 x 65 x 62 cm.  
Storage cart 118 x 65 x 62 cm.





**900897** Estantería metálica 2000 x 2000 x 600 mm.

Fabricado con armazón de acero estirado en frío de dimensiones 20 x 20 x 1,5mm. Malla soldada de 50 x 50 con un espesor de 5mm. Todo el armario tratado contra la corrosión. Medidas de 2000 x 2000 x 600 mm. Dispone de 4 estantes metálicos regulables en altura. Sostenido por 6 patas cubiertas de goma de 10 cm, que evitan el deterioro del pavimento. Sistema de apertura de doble puerta con bisagras soldadas al armazón, para facilitar la entrada y recogida de material. Sistema de cierre por candado.

*Metal shelving 2000x2000x600 mm. Made of steel frame cold drawn size 20 x 20 x 1.5 mm. Welded Mesh 50 x 50; thickness 5mm. All the closet is treated for corrosion. Measures 2000 x 2000 x 600 mm. It has 4 height adjustable shelves. Supported by 6 10 cm. rubber-coated legs which prevent the deterioration of the pavement. Opening system with double door hinges welded to frame, to facilitate entry and retrieval of materials. Lock closure system.*

**900896** Carro Porta Balones 1230 x 680 x 780 mm.

Fabricado con armazón de acero estirado en frío de dimensiones 20 x 20 x 1,5mm. Malla soldada de 50 x 50 con un espesor de 5mm. Todo el armario tratado contra la corrosión. Las dimensiones son de 1200 x 680 x 780 mm. Con 4 ruedas giratorias forradas de goma y con freno. Diámetro de 6 cm. Capacidad para 40 balones. Sistema superior de apertura con bisagra soldada a la estructura, para facilitar la entrada y recogida de balones. Sistema de cierre por candado.

*Balls Trolley 1230 x 680 x 780 mm.*

*Made of steel frame cold drawn size 20 x 20 x 1.5 mm. Welded Mesh 50 x 50; thickness 5mm. All the body treated for corrosion. Dimensions 1200 x 680 x 780 mm. With 4 rubber-coated wheels and brake. Diameter 6 cm. Capacity for 40 balls. System hinged opening top welded to the structure, to facilitate entry and collection of footballs. Lock closure system.*

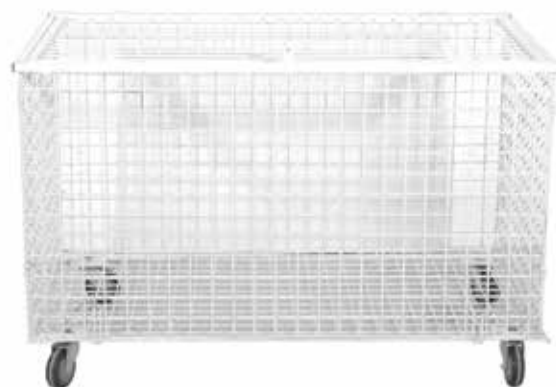

# COMPRESOR



## 900 899 00 COMPRESOR PORTÁTIL MULTIFUNCIÓN

A diferencia de otros compresores, está fabricado con 2 potentes motores de acero inoxidable que ofrecen el inflado adecuado para todo tipo de productos. Es la elección perfecta para inflar neumáticos de automóviles, bicicletas, pelotas, colchones de aire, balsas de aire y más. Incluye todos los accesorios necesarios para hinchar balones, colchonetas neumáticas, etc... Está diseñado con una pantalla LCD, fácil de leer, que muestra con precisión la presión en 3 modos (PSI, BAR, KPA). Incorpora una linterna de luz LED, para poder ser usado en la oscuridad. Peso del artículo: 1.8 kg.

Dimensiones del producto: 30\*11\*17 cm.

Tipo de bombilla LED

Características especiales: Portátil, CA/CC, Digital

Potencia: 120 vatios.

## 900 899 00 COMPRESSOR MULTIFUNCTION PORTABLE

Comparing to other compressors, this one is made with 2 powerful motors of stainless steel, that brings the better inflate option for every product. The perfect choice to inflate car wheels, bikes wheels, balls, air rafts ... etc. Includes all accessories necessary for each type of inflate. Designed with an LCD screen, easy to understand, that display in detail the pressure in 3 ways: PSI, BAR, KPA.

LED light lantern included, to offer the possibility of use in the dark.

Weight: 1.8 kg.

Measures: 30\*11\*17 cm.

Type of light: LED

Special features: Portable, CA/CC, Digital

Power: 120 wats.







**900 900** Compresor pequeño. Tensión: 230V. Frecuencia: 50HZ. Máx. presión 80psi. Potencia: 85w. No tiene termostato. Trabajar durante 10 minutos y descansar durante 10 minutos.

*Voltage: 230V. Frequency: 50HZ. Max pressure 80psi. Rated power input: 85watt. Allow pump to cool for 10 minutes after each 10 minutes of continuous use.*



**900 903** Compresor mediano. Tensión: 220-240V. Frecuencia: 60HZ. Caudal: 2 bar . Máx presión: 80psi. Potencia: 95 w. Trabaja durante 2 horas seguidas. Tiene termostato.

*Voltage: 220-240V. Frequency: 60HZ. Flow rate: 2bar o 15.5LPM. Max pressure 80psi Rated power input: 95 watt .Non-Stop performance: 2 hours. Automatic reset thermal overload protector.*



**900 906**

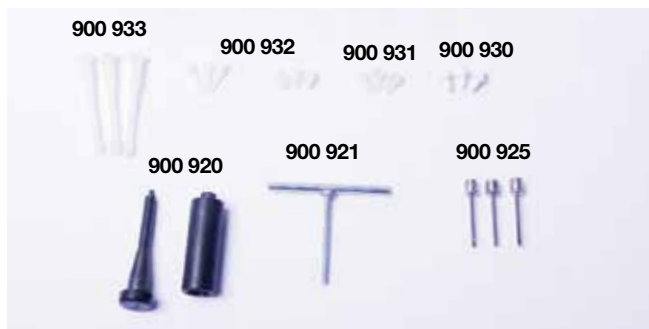

**900 906** Bomba hinchado grande de 25 cm. - *Air pump 25 cm.*

**900 920** Inyector válvula. - *Valves injector.*

**900 921** Extractor válvula. - *Valves extractor.*

**900 925** Agujas finas. Bolsa de 6 unidades. - *Needles (6 pcs bag)*

**900 930** Válvulas de caucho. - *Rubber valves.*

**900 931** Válvulas PU. - *PU valves.*

**900 932** Tapones para balones. - *Plastic balls stopper.*

**900 933** Tapones para pelotones. - *Amaya Flexi and kangaroo stopper.*



**900 909** Bomba hinchado vertical de 60 cm. *Vertical air pump 60 cm.*



**900 907** Bomba hinchado pie. - *Air pump for feet.*



**436 802 00** Bomba hinchado básica - *Basic air pump.*

## A

AGUJAS PARA COMPRESOR Y BOMBAS	281
AJEDREZ - PIEZAS SUELTAS	151
AJEDREZ CRONÓMETRO	151
AJEDREZ JUEGOS GIGANTES	152
AJEDREZ TABLEROS	151
ALETAS NATACION SILICONA	182
ALFOMBRILLA DE SPEED CUPS CON FUNDA	175
ALMOHADILLA CERVICAL Y LUMBAR	267
ALMOHADILLAS EQUILIBRIO	51
ANILLAS ENGARZABLES	24
ANILLAS GEOMÉTRICAS ENGARZABLES	25
ANIMALES -SET figuras	165
ARBOL COLORES- TREE FANTASY COLORS	33
ARBOL VERDE- TREE FANTASY GREEN	33
ARCO AMAYA KIDS	140
ARCO AMAYA SCHOOL	140
ARCO DE ENTRENAMIENTO	195
ARMARIO JAULA METALICO	279
ARO BASKET	215
ARO BUCEO	188
ARO CANASTA DOBLE	136
ARO CANASTA FOOTCESTO	136
ARO CANASTA NETBALL	138
ARO CON GUIA	139
ARO FOAM	153
ARO HULA HOOP BICOLOR	149
ARO MALABAR	174
ARO PINCHOS 160 MM -UNIDAD	267
ARO PSICOMOTRICIDAD	18
ARO RITMICA HR COMPETICION	237
ARO RITMICA COMPETICION 18 MM.	238
ARO RITMICA ENTRENAMIENTO 18 MM.	239
ARQUILLOS SUPERIORES PORTERIA	195
ARQUITECTURA CAUCHO SOFT 25 PIEZAS	22
ARQUITECTURA PIRAMIDAL	23
ARQUITECTURA PLANA	26
ARQUITECTURA TUBOS ENGARZABLES XXL	27
ASIEN TO SALTARIN	65

## B

BALANCE BOARD 40 CM.	265
BALANCE BOARD TORTUGA	11
BALANCE CUSHION 34	265
BALANCIN TRES PLAZAS	149
BALDOSAS CAUCHO	112
BALON MEDICINAL RECICLADO	264
BALON MEDICINAL ROJO	264
BALON MEDICINAL VERDE	264
BALON MEDICINAL CAUCHO HIGH GRIP	263
BALON MEDICINAL TECNOCAUCHO	263
BALON BALONMANO CAUCHO	207
BALÓN BALONMANO CUERO SOFT TOUCH	206
BALON BALONMANO MICRON	206
BALON BALONMANO SOFT TPE	207
BALON BALONMANO TECNOCAUCHO	207
BALON BASKET BICOLOR	210
BALON BASKET BICOLOR (CELULAR PLUS)	209
BALON BASKET BICOLOR (CELULAR)	210
BALON BASKET CUERO SINTETICO	210
BALON BASKET NARANJA	210
BALON BASKET NARANJA (CELULA PLUS)	209
BALON BASKET PVC	211
BALON BASKET SOFT TPE	211
BALON BASKET TECNOCAUCHO	211
BALON BASKET TRICOLOR N.3	210
BALON FUTBOL CAUCHO GLADIATOR	192

## P

BALON FUTBOL CAUCHO TOP STAR	192
BALON FUTBOL CUERO BREEZE N.5	191
BALON FUTBOL CUERO BURAN N.5	190
BALON FUTBOL CUERO CAPITAN	191
BALON FUTBOL CUERO CLASSIC N.5	192
BALON FUTBOL CUERO ETESIO N.4	190
BALON FUTBOL CUERO ETESIO N.5	190
BALON FUTBOL CUERO FIVE N.5	191
BALON FUTBOL CUERO PLATINUM N.4	191
BALON FUTBOL CUERO PLATINUM N.5	191
BALON FUTBOL CUERO TAPSUS	190
BALON FUTBOL CUERO YTTERBIUM N.5	190
BALON FUTBOL PVC CAPTAINS	192
BALON FUTBOL PVC NEON	192
BALON FUTBOL PVC NEW TEAM	72
BALÓN FUTBOL PVC RAINBOW	72
BALON FUTBOL PVC ROYAL	193
BALON FUTBOL PVC SPRING	192
BALON FUTBOL PVC -SUPER 5,TEAM,FURIA	163
BALON FUTBOL PVC VULCANO	193
BALON FUTBOL SALA CAUCHO N.3	205
BALON FUTBOL SALA CAUCHO N.4	205
BALON FUTBOL SALA CUERO Nº4	204
BALON FUTBOL SALA CUERO JUNIOR N.3	205
BALON FUTBOL SALA CUERO KIENYKE	204
BALON FUTBOL SALA CUERO SENIOR N.4	205
BALON FUTBOL SALA CUERO SOFT TOUCH	205
BALON FUTBOL SALA PVC N.3	205
BALON FUTBOL SALA THERMOLINK	204
BALON FUTBOL TECNOCAUCHO	192
BALON MINIRUGBY CAUCHO (CELULAR) T3 -	235
BALON MINIVOLLEY 190 BLANCO	219
BALON MINIVOLLEY SOFT TPE SUAVE	219
BALON MINIVOLLEY TECNOCAUCHO	219
BALON RUGBY CAUCHO (CELULAR) T5	235
BALON TRES DEPORTES	163
BALON VOLLEY CAUCHO BLANCO (CELULAR)	218
BALON VOLLEY CAUCHO TRICOLOR (CELULAR)	218
BALON VOLLEY CUERO "SOFT TOUCH" BLANCO	218
BALON VOLLEY CUERO SOFT TOUCH	218
BALON VOLLEY FOAM- CAUCHO NARANJA	218
BALON VOLLEY PVC PLAYA DECORADO	72
BALON VOLLEY SOFT TPE	219
BALON VOLLEY TECNOCAUCHO	218
BALON VOLLEY TERMOPLÁSTICO- BLANCO	218
BALON WATERPOLO CAUCHO CELULAR	186
BANCO SUECO	277
BANDA DE ESTIRAMIENTOS AJUSTABLE	260
BANDERIN CORNER FLEXIBLE - 1 UNIDAD	200
BANDERIN LINIER PRO - PAR	201
BAQUETAS	105
BARRA DE BALLET	258
BARRA DE PARED PARA COLCHONETAS	269
BARRA FLOTANTE 65 MM	181
BARRAS MAGNETICAS	29
BASE ABATIBLE PORTERIA	195
BASE CAUCHO PARA PICAS DE 25 MM.	199
BASE HUECA RELLENABLE	19
BASE MACIZA 1.8KG.	19
BASE PARA PICAS SLALOM	199
BASE PARA SILUETAS FLEXIBLES	199
BASE POUL BALL	137
BASE RELLENABLE SCHOOL	137
BATE BASE BALL FOAM	229
BATE BASE BALL MADERA	230
BOLAS ENGARZABLES	24
BOLOS FOAM	77



	P
BOLOS POLIETILENO (JUEGO)	150
BOLSO PORTA-BALONES PARA 16 UDS.	203
BOLSO PORTAPARATOS RITMICA UNIVERSAL	240
BOLSOS PORTAPARATOS RITMICA	241
BOMBA HINCHADO 25 CM.	281
BOMBA HINCHADO KANGUROS Y PELOTONES	281
BOMBA HINCHADO MANO VERTICAL	281
BOMBA HINCHADO PIE	281
BONGOS	101
BOOMERAG-MINI	153
BOTELLA DE AGUA 750ML. -UNIDAD	201
BRAZALETE CAPITÁN	201

**C**

CABASA	99
CADENAS ENGARZABLES PLANAS	25
CAJA CHINA	99
CAJA ENROLLACINTAS RITMICA	248
CAJAS CONTRAPESOS BASKET	213
CAJAS CONTRAPESOS MINIBASKET .	215
CAJON	101
CAMA ELÁSTICA FUNHOP D100	147
CAMA GUARDERIA -	113
CAMAS ELASTICAS	148
CAMPANAS TUBULARES	103
CAMPANITAS MANO	98
CAMPANITAS MESA	97
CAMPANITAS MUSICALES CON LIBRO	97
CAMPANITAS RUEDA	98
CAMPANITAS TORTUGA	97
CANASTA BABY BASKET	217
CANASTA DE JUEGOS	146
CANASTA DOBLE SCHOOL	136
CANASTA FIJA BASKET - POSTE RECTANGULAR	212
CANASTA FIJA BASKET - POSTE REDONDO	214
CANASTA FIJA MINI-BASKET - P. RECTANGULAR	212
CANASTA FIJA MINI-BASKET - P. REDONDO	214
CANASTA FOOTCESTO SCHOOL	136
CANASTA NET BALL BASE RELLENABLE	217
CANASTA STREET BASKET	216
CANASTA TRANSLADABLE BASKET/ MINIBASKET	213
CARIOCAS- POI	177
CARPETA TÁCTICA	203
CARRILLON 13 COLORES	104
CARRILLÓN CON BAQUETAS	103
CARRILLONES	103
CARRO ALMACENAMIENTO	278
CARRO ESTANTERIA 16 BALONES	278
CARRO JAULA PORTA-BALONES	279
CARRO PORTA 5 SILUETAS ENTRENO.	199
CARRO PORTACOLCHONETAS 2000X1000 MM.	275
CARRO SCOOTER	143
CASCABELES	98
CASCABELES DE MANO PLÁSTICO	99
CASCO AJUSTABLE	8
CASCO BASE BALL	230
CASCO DISEÑO	9
CASCO GRAFITO	8
CASCO INFANTIL	9
CASCO SKATE	9
CASTAÑUELAS	99
CEDAZO (PLAYA)	187
CESTA BASKET FLOTANTE	186
CESTA LACROSSE	145
CESTA MULTIBASKET UNIDAD	138

	P
CHICHONERA	63
CILINDRO CACAHUET FOAM MANO	267
CILINDRO CACAHUET PVC 75 CM.	71
CILINDRO INFANTIL 42 CM.	71
CILINDRO PVC 75 CM.	71
CINTA ADHESIVA ARCO IRIS -	243
CINTA ADHESIVA ESPEJO -	243
CINTA ADHESIVA ESTRELLA -	243
CINTA ADHESIVA PAVO REAL	243
CINTA ADHESIVA CAMALEON	242
CINTA ADHESIVA PURPURINA	243
CINTA ADHESIVA RADIANT	243
CINTA METRICA	277
CINTA METRICA 30 M. SUELO	277
CINTA RITMICA COMPETICION	247
CINTA RITMICA ENTRENAMIENTO	247
CINTURON CASCABELES	98
CINTURÓN FLOTANTE	182
CIRCULOS DE CAUCHO DIAM.23 CM..	14
CLAVES MADERA (2 UNIDADES)	100
COLCHONETA	272
COLCHONETA BASIC	270
COLCHONETA BASIC INFANTIL	270
COLCHONETA INFANTIL	274
COLCHONETAS YOGA PILATES	268
COMETAS	160
COMPRESOR MEDIANO	281
COMPRESOR MULTIFUNCION	280
COMPRESOR PEQUEÑO NUEVO	281
CONECTOR BARRAS FLOTANTE	181
CONJUNTO BLOQUES CONSTRUCCION	21
CONJUNTO FIGURAS CUERO SINTETICO	85
CONO FLEXIBLE	19
CONO REDONDO	19
CONOS	19
CONOS SEÑALIZACION Y PSICOMOTRICIDAD	200
CONTRAPESOS VOLLEY-TENIS	222
CRONOMETRO	203
CROTALOS	100
CRUZ UNION -PASILLO ACOPLABLE	47
CRUZ UNION- PASILLO SEMICIRCULAR	47
CUADROS DE CAUCHO DE 23X23 CM.	14
CUBIERTA ELASTICA PARA ARO RITMICA	240
CUBO POULBALL INFLABLE	137
CUERDA DE BATIDA/SOGATIRA Ø26 MM.	138
CUERDA DE REEMPLAZO ARCO AMAYA	140
CUERDA GUARDERIA CASCABEL	60
CUERDA MANGO FOAM	142
CUERDA PARA YOYO	169
CUERDA PSICOMOTRICIDAD	18
CUERDA RITMICA COMPETICION	251
CUERDA RITMICA ENTRENAMIENTO	251
CUERDA RITMICA MULTICOLOR	250

**D**

DADO 15X15	60
DADO 15X15 CASCABEL	60
DADO 20X20	60
DADO EVA PIZARRA	38
DADO FOAM RECUBIERTO 20X20 CM	60
DADO FOAM VENTANAS 10X10 CM.	39
DAMAS- JUEGO GIGANTE DAMAS	152
DAMAS- TABLERO AJEDREZ Y DAMAS	152
DELANTAL JARDINERIA PARA NIÑOS	117
DIABOLO FLOWER STICK	174

	P		P
DIABOLO INICIACIÓN SEMIESFÉRICO	172	FIGURA CUERO SINTETICO (85)	89
DIABOLOS CAUCHO	170	FIGURA CUERO SINTETICO (86)	89
DIABOLOS TERMOCAUCHO	172	FIGURA CUERO SINTETICO (87)	89
DIABOLOS TRANSPARENTE	171	FIGURA CUERO SINTETICO (88)	89
DIANA PARA TIRO CON ARCO	141	FIGURA CUERO SINTETICO (89)	89
DIANAS MADERA Y DARDOS	156	FIGURA CUERO SINTETICO (90)	89
DISCO ACUATICO PVC.	186	FIGURA CUERO SINTETICO (92)	89
DISCO CAUCHO	153	FIGURA EN FOAM- CAMELLO	94
DISCO CHINO	175	FIGURA EN FOAM- COCHE	94
DISCO DE EQUILIBRIO UNIDAD	51	FIGURA EN FOAM- COCODRILO	94
DISCO LANZAMIENTO	233	FIGURA EN FOAM- GUSANO	95
DISCO RAQUETA	157	FIGURA EN FOAM- MARIQUITA	95
DISCOS FOAM	153	FIGURA EN FOAM- VACA	95
DISCOS VOLADORES	154	FIGURA FOAM RECUBIERTO (10)	81
<b>E</b>		FIGURA FOAM RECUBIERTO (11)	81
ECO BALON	161	FIGURA FOAM RECUBIERTO (12)	81
EGGS GAME	36	FIGURA FOAM RECUBIERTO (13)	81
ELEFANTE MEDICIÓN ALTURA	52	FIGURA FOAM RECUBIERTO (14)	81
ENGARCE PICAS (12/U)	18	FIGURA FOAM RECUBIERTO (15)	81
ENGARCE UNIVERSAL	18	FIGURA FOAM RECUBIERTO (16)	81
ESCALERA AGILIDAD	197	FIGURA FOAM RECUBIERTO (17)	81
ESCALERAS BRAQUIACIÓN	20	FIGURA FOAM RECUBIERTO (18)	81
ESPALDERA MADERA	262	FIGURA FOAM RECUBIERTO (19)	81
ESPALDERA METALICA FUNCIONAL	262	FIGURA FOAM RECUBIERTO (20)	82
ESPEJOS	114	FIGURA FOAM RECUBIERTO (21)	83
ESPINILLERAS FUTBOL	202	FIGURA FOAM RECUBIERTO (22)	83
ESQUINAS DE CAUCHO	14	FIGURA FOAM RECUBIERTO (23)	82
ESTANTERIA COLGADO DE COLCHONETAS	269	FIGURA FOAM RECUBIERTO (24)	83
ESTERILLA YOGA	269	FIGURA FOAM RECUBIERTO (25)	82
ESTRELLAS DE CAUCHO	14	FIGURA FOAM RECUBIERTO (27)	82
ESTRUCTURA SLACKLINE	178	FIGURA FOAM RECUBIERTO (28)	84
EXTRACTOR TAPON	281	FIGURA FOAM RECUBIERTO (29)	84
<b>F</b>		FIGURA FOAM RECUBIERTO (30)	84
FIGURA CUERO SINTETICO (54)	86	FIGURA FOAM RECUBIERTO (31)	84
FIGURA CUERO SINTETICO (55)	86	FIGURA FOAM RECUBIERTO (32)	84
FIGURA CUERO SINTETICO (56)	86	FIGURA FOAM RECUBIERTO (33)	84
FIGURA CUERO SINTETICO (57)	86	FIGURA FOAM RECUBIERTO (34)	84
FIGURA CUERO SINTETICO (58)	86	FIGURA FOAM RECUBIERTO (35)	82
FIGURA CUERO SINTETICO (59)	86	FIGURA FOAM RECUBIERTO (36)	82
FIGURA CUERO SINTETICO (60)	86	FIGURA FOAM RECUBIERTO (39)	82
FIGURA CUERO SINTETICO (61)	86	FIGURA FOAM RECUBIERTO (40)	82
FIGURA CUERO SINTETICO (62)	86	FIGURA FOAM RECUBIERTO (42)	84
FIGURA CUERO SINTETICO (63)	86	FIGURA FOAM RECUBIERTO (43)	82
FIGURA CUERO SINTETICO (66)	87	FIGURA FOAM RECUBIERTO (45)	83
FIGURA CUERO SINTETICO (67)	87	FIGURA FOAM RECUBIERTO (47)	83
FIGURA CUERO SINTETICO (68)	87	FIGURA FOAM RECUBIERTO (49)	83
FIGURA CUERO SINTETICO (69)	87	FIGURA FOAM RECUBIERTO (51)	83
FIGURA CUERO SINTETICO (70)	87	FIGURAS 4 EQUILIBRIO	77
FIGURA CUERO SINTETICO (71)	87	FIGURAS ANTIESTRES 'RUGBY'	164
FIGURA CUERO SINTETICO (73)	87	FIGURAS ENGARZABLES "SOFT"	24
FIGURA CUERO SINTETICO (74)	88	FIGURAS PARA COSER	26
FIGURA CUERO SINTETICO (75)	88	FLAUTAS	103
FIGURA CUERO SINTETICO (76)	88	FLECHA TIRO CON ARCO	141
FIGURA CUERO SINTETICO (77)	87	FLECHAS CAUCHO CURVAS	15
FIGURA CUERO SINTETICO (78)	88	FLECHAS CAUCHO RECTAS	15
FIGURA CUERO SINTETICO (79)	88	FLORES JARDÍN	34
FIGURA CUERO SINTETICO (80)	88	FLOTADOR PISCINA	187
FIGURA CUERO SINTETICO (81)	88	FUNDA BASIC	270
FIGURA CUERO SINTETICO (82)	88	FUNDA BASIC QUITAMIEDOS	271
FIGURA CUERO SINTETICO (83)	89	FUNDA COLCHONETA	272
FIGURA CUERO SINTETICO (84)	89	FUNDA COLCHONETA INFANTIL	274
		FUNDA QUITAMIEDOS	273
		FUNDA QUITAMIEDOS PLEGABLE	274

<b>G</b>	<b>P</b>
GAFAS NATACION	185
GEAR SET	35
GORROS NATACION	184
GRAN BASE UNIVERSAL	63
GRAVITY CONTACT BALL LUMINISCENTE	173
GUANTE BASEBALL	230
GUANTES DE JARDINERIA	117
GUANTES FUTBOL	202
GUIRO	99
GUIRO 2 TONOS	99
<b>H</b>	
HINCHADOR MANUAL	249
HOCKEY FOAM 12 MAZAS + PELOTA	145
HUERTO ESCOLAR	116
HUEVOS SONOROS	99
<b>I</b>	
INDIAKAS	155
INDICADOR DE CAMBIO DE JUGADOR	201
INYECTOR VALVULAS	281
ISLAS "JUMP"	43
ISLAS DE EQUILIBRIO DE TECNOCAUCHO	43
<b>J</b>	
JABALINA FOAM	155
JUEGO CESTA	139
JUEGO CUCURUCHO	139
JUEGO DE SALTO RAYUELA	52
JUEGO LANZAMIENTO AROS	138
JUEGO SUPERCATCH	139
JUMP FITNESS TRAMP - CAMA ELÁSTICA	266
JUMPING CAR -COCHE CARRERAS	64
<b>K</b>	
KANGURO Ø45 CM	64
KANGURO Ø55 CM	65
KICKING BALL	70
KIT DE JARDINERIA PARA HUERTO ESCOLAR	117
KIT ENTRENO BASES Y PICAS	19
<b>L</b>	
LA CUEVA	59
LADRILLOS PSICOMOTRICIDAD	21
LISTON PARA SALTOMETRO EN FOAM	234
LOCOMOTORA GIANT TRAIN	53
LUBRICANTE RODAMIENTO YOYO	169
LUMINOSOS PARA LA CUEVA	59
LUMMIC 4 UDS.	16
LUMMIC UNIDAD SUELTA	17

<b>M</b>	<b>P</b>
MAGIC WEAVING	36
MAGNETIC ART CASE	31
MAGNETIC BUILDING TUNEL	32
MAGNETIC CUBES	31
MAGNETIC PAD	42
MAGPAG DOTS	37
MAGSMARTERS	29
MAGTILES BUILDING	30
MANOPLA VELCRO	139
MANOPLAS DE NATACION	182
MANOS DE CAUCHO	15
MARACAS	99
MARCADOR PARA PLANTAS	117
MASCARA BASE BALL	231
MASTIL CON CINTAS	63
MAZA MALABAR	173
MAZA RITMICA BICOMPONENTE	244
MAZA RITMICA TP	246
MEDIDOR DE PRESIÓN	203
MEGAFONO 25 W.	277
MESA MADERA	131
MESA MADERA HERRADURA	132
MESA MADERA REDONDA	132
MESA SFERA	115
METALOFONO	105
MINI ARQUITECTURA	26
MINI CASCABEL COLORES	99
MINI SENSACIONES PLANTARES	48
MINI-HOCKEY	143
MISIL FOAM	156
MIX FIGURAS ENGARZABLES	25
MONOCICLO LLANTA PVC	177
MOSAICO CÍRCULOS ENGARZABLES	23
MOSAICO CUADROS ENGARZABLES	23
MOSAICO GRANDE	23
MUEBLE FOAM- BANCOS	129
MUEBLE FOAM- COJÍN	137
MUEBLE FOAM- MESA CILINDRO	122
MUEBLE FOAM- MESA HEXAGONAL CON PIE	121
MUEBLE FOAM- MESA HEXAGONAL	121
MUEBLE FOAM- SOFA FOAM	122
MUEBLE FOAM- PUFF	119
MUEBLE FOAM- RINCON (2 SILLAS+MESA)	124
MUEBLE FOAM- SERPIENTE	128
MUEBLE FOAM- SET (6 SILLAS+MESA)	125
MUEBLE FOAM- SET (SOFÁ+2 SILLONES+MESA)	123
MUEBLE FOAM- SET COJINES	126
MUEBLE FOAM- SILLA CURVA PEQUEÑA	119
MUEBLE FOAM- SILLA DOBLE	120
MUEBLE FOAM- SILLA PUPITRE	118
MUEBLE MADERA BAJO	133
MUEBLE MADERA GRANDE	134
MUEBLE MADERA PEQUEÑO	133
<b>N</b>	
NUMEROS DE CAUCHO DEL 0 AL 9	15
NUMEROS DE CAUCHO DEL 1 AL 30.	15
<b>O</b>	
OBSTACULOS JUMP	19



## P

PALA (PLAYA)	187
PALA TENIS MESA	227
PALOS DE LLUVIA	99
PALOS PARA DIABOLO	172
PANDERETA MINI DE PLÁSTICO	100
PANDERETAS	100
PAÑUELO MALABAR (B-3/U.)	174
PARACAIDAS	62
PARACAIDAS POTENCIADOR DE VELOCIDAD	198
PASILLO DE EQUILIBRIO MULTIPOSICION	46
PASILLO ISLAS	44
PASILLO SEMICIRCULAR CURVO	47
PASILLO SEMICIRCULAR RECTO	47
PASILLO SENSACIONES PLANTARES	49
PASILLO SNAKE	49
PASTILLA HOCKEY	45
PATINETE ESCOLAR 2 RUEDAS	144
PEDAL KART MEDIANO	5
PEDAL KART PEQUEÑO	6
PEDALIN	6
PEGATINAS CAUCHO ANTIDESLIZANTES	177
PELOTA ANTIESTRES	275
PELOTA BASEBALL CUERO	164
PELOTA CON ASA	230
PELOTA CON MANGO	142
PELOTA CRISTAL	142
PELOTA CRISTAL 100	162
PELOTA CUERO	163
PELOTA ESPONJA CAUCHO	228
PELOTA ESPONJA PVC 40/55	164
PELOTA FANTASIA CASCABEL	164
PELOTA FOAM	164
PELOTA FOAM 190 BASKET NUEVO	78
PELOTA FOAM 190 VOLLEY NUEVO	211
PELOTA FOAM BALONMANO NUEVO	219
PELOTA FOAM BASEBALL 70 MM	207
PELOTA FOAM FRONTON	229
PELOTA FOAM FUTBOL	228
PELOTA FOAM RECUBIERTO	193
PELOTA FOAM RUGBY	79
PELOTA FRONTENIS	235
PELOTA GEL BALL	221
PELOTA HOCKEY	267
PELOTA LACROSSE PVC 70, PESO 65 GRS.	144
PELOTA LANZAMIENTO JABALINA	145
PELOTA LANZAMIENTO PESO	233
PELOTA LISA PVC	233
PELOTA MAGICA ESPECIAL	73
PELOTA MALABAR	162
PELOTA MINIDEPORTIVA 100	173
PELOTA MINI-TENIS OFICIAL	163
PELOTA NACARADA	221
PELOTA PERFORADA CASCABEL	162
PELOTA PINCHOS	73
PELOTA PISCINA	267
PELOTA PLAYA HINCHABLE	74
PELOTA POM POM	162
PELOTA RELIEVE	158
PELOTA RITMICA ENTRENO	163
PELOTA RITMICA GALAXI	256
PELOTA RITMICA INFANTIL ENTRENO	255
PELOTA RITMICA INFANTIL TECNOCAUCHO	256
PELOTA RITMICA TECNOCAUCHO GLITTER	252
PELOTA RITMICA IRIDISCENTE	253
PELOTA RITMICA LISA	254
PELOTA RITMICA MARMOL	256
PELOTA RITMICA NACAR	255
PELOTA RITMICA TECNOCAUCHO HOLOSCENTE	255
PELOTA RITMICA TECNOCAUCHO LISA	

## P

PELOTA RITMICA TRANSPARENTE	256
PELOTA RUGOSA CAUCHO CELULAR	73
PELOTA RUGOSA DECORADA	73
PELOTA RUGOSA PVC	73
PELOTA SOFTBALL PIEL	230
PELOTA SONORA 150 BALONMANO CELULAR	207
PELOTA SONORA 180 FUTBOL SALA CELULAR	205
PELOTA SONORA BASKET CELULAR	209
PELOTA SONORA VOLLEY CELULAR	219
PELOTA TENIS	221
PELOTA TENIS MESA	227
PELTON AEROFLOTANTE	69
PELTON FLOTANTE	70
PELTON PINCHOS SENSORIAL	67
PELTON TECNOCAUCHO	66
PELTON TECNOCAUCHO LITE	66
PELTON TPE	67
PEONZAS	176
PERCUSIÓN SET	102
PETANCAS	150
PETOS	201
PICA 1 M.	18
PICA 1,20 M.	18
PICA 1,60 M.	18
PICA 35 CM.	18
PICA 70 CMS.	18
PICA MADERA 1,20 MT.	265
PICA SLALOM	199
PICAS BUCEO (JUEGO 6/U.)	188
PIE APOYO DE XILOFONO Y METALOFONO	105
PIEDRAS DE RIO	43
PIES DE CAUCHO	15
PIES Y MANOS FOAM	77
PIEZA DE INICIO- PASILLO SEMICIRCULAR	47
PIEZA PARA PICA REGULABLE ALTURA	19
PIEZA UNION- PASILLO ACOPLABLE	47
PIEZAS DE CONSTRUCCIÓN	25
PISCINA CUADRADA 52CM.	73
PISCINA CUADRADA INFERIOR	76
PISCINA DE JUEGOS NYLON	73
PISCINA EN FORMA DE OCHO	75
PISCINA FORMA DE CRUZ 52 CM.	75
PISCINA FORMA DE OCHO 30CM.	75
PISCINA PARA ARENA REDONDA	73
PISCINA REDONDA 30 CM.	76
PISCINA REDONDA 52 CM.	76
PISCINAS- PIEZAS	74
PIVOTES UNION LADRILLO	21
PIZARRA MAGNÉTICA	104
PIZARRA TACTICA	203
PLATAFORMA ROCKET	12
PLATOS MUSICALES 20 CM. PAR	100
POLO FOAM -12 MAZAS + PELOTA	145
PORTA BOTELLAS DE AGUA	201
PORTERIA FUTBOL ALUMINIO	194
PORTERIA FUTBOL PERFIL PVC	196
PORTERÍA FUTBOL PVC CON ESCUADRA	196
PORTERIA FUTBOL TUBO REDONDO	196
PORTERIA HOCKEY	144
PORTERÍA HOCKEY ACERO UNIDAD	146
PORTERIA LANZAMIENTO DISCOS	146
PORTERIA TCHOUKBALL - UNIDAD	146
PORTERIA WATERPOLO 90X70X60 CM.	186
POSTE CORTO SCHOOL para juego badminton	137
POSTE LARGO SCHOOL para juego volley	137
POSTES BADMINTON-TENIS SCHOOL	137

## P

	<b>P</b>
POSTES TENIS ALUMINIO FIJOS OVALADO	222
POSTES TENSADO DE RED	195
POSTES VOLLEY ALUMINIO OVALADO	220
POSTES VOLLEY FIJOS ALUM. CUADRADO	220
POSTES VOLLEY FIJOS ALUMINIO OVALADO	220
POSTES VOLLEY TRANS.ALUM CUADRADO	220
POSTES VOLLEY-BADMINTON SCHOOL	137
POULBALL SCHOOL	138
POZAL PLAYA	187
PRO SLACKLINE CLASIC	178
PROTECTOR ARBOL PRO SLACKLINE	178
PROTECTOR CUERPO BASEBALL	231
PROTECTOR ESPALDA RITMICA	249
PULL BOY	181
PULSERA CASCABELES	98
PULSOMETRO	203
PUNTA DE FOAM FLECHA	141
PUNTERAS RITMICA	249

**Q**

QUICK CUPS	175
QUITAMIEDOS	273
QUITAMIEDOS BASIC	271
QUITAMIEDOS PLEGABLE	274

**R**

RAQUETA BADMINTON	224
RAQUETA BDMINTON SCHOOL	223
RAQUETA MALLA	158
RAQUETA PADDEL PLAYA	158
RAQUETA PLAYA	159
RAQUETAS TENIS	221
RASPA	99
RECORRIDO MOTRIZ	55
RED BADMINTON	226
RED BASKET	215
RED FUTBOL 11	195
RED FUTBOL 7	195
RED INDIVIDUAL PARA BALON	203
RED PARA 8 BALONES	203
RED TENIS TRIPLE DE COMPETICION	222
RED VOLLEY 186X100 CM. FLOTANTE	186
RED VOLLEY OFICIAL	220
REGADERA CON PULVERIZADOR	117
REGLETAS MATEMÁTICAS SOFT	22
RELOJ DE PARED	52
RINGOS PISCINA	188
R-MAGBLOCK	31
RODILLERAS RITMICA RITMICA	249
RODILLERAS-CODERAS-PROTECTOR	10
RUEDAS ENGARZABLES	23
RUEDAS PARA CAMA GUARDERIA Y HUERTO	113

**S**

SABANITA PARA CAMA GUARDERIA	113
SABLE ESGRIMA FOAM	77
SACOS PARA CARRERAS	147
SALTOMETRO 2.5 MT CON BASES	234
SAMBINOS	99

	<b>P</b>
SAQUITOS COLORES	13
SAQUITOS LETRAS	13
SAQUITOS NUMEROS	13
SEMAFOROS	4
SEMIESFERAS DE BUCEO	188
SEMIESFERAS GIGANTES PARA EQUILIBRIO	54
SENSACIONES OLFATIVAS	61
SENSACIONES PLANTARES BASIC	48
SENSACIONES PLANTARES ORIGINAL	49
SENSACIONES TACTILES INFANTIL	61
SEÑAL TRAFICO	3
SET ARBITRO	201
SET TENIS-VOLLEY	220
SILBATOS	203
SILLA CUBO	115
SILLA MADERA	130
SILLA SFERA - PE	115
SILUETA ENTRENO.180 CM	199
SILUETAS FLEXIBLES	199
SKIPIBALL	71
SOPORTE BASEBALL	231
SOPORTE PARA CONO-PICA	18
SPACE CONSTRUCTION	32
STICK HOCKEY MANGO REDONDO	143
STICK HOCKEY OVALADO	144
STICK MANGO ALUMINIO	144
SUELO LIQUIDO	50
SUELO PUZZLE (4-8-4) 100*100*1	108
SUELO PUZZLE BALDOSA 100*100*1	108
SUELO PUZZLE BALDOSA 100*100*2	108
SUELO PUZZLE BALDOSA 50*50*1	108
SUELO PUZZLE BALDOSA 50*50*2	107
SUELO PUZZLE ESQUINA 2 cm.	107
SUELO PUZZLE ESQUINA1 cm.	108
SUELO PUZZLE LATERAL 1 cm.	108
SUELO PUZZLE LATERAL 2 cm.	107
SUELO PUZZLE SUELO AUTUMN	109
SUELO PUZZLE SUELO SNOW	110

**T**

TABAS PLASTICO MACIZO	60
TABLERO BASKET Y MINI BASKET	215
TABLETS -LCD	40
TAMBOR DE LENGUA	105
TAMBOR DE OLAS 25 CM.	99
TAMBORES	100
TAPIZ FLOTANTE	180
TAPIZ FLOTANTE AGUJEROS	181
TAPIZ FLOTANTE -CANGREJO	183
TAPIZ FLOTANTE -LANCHA	183
TAPIZ FLOTANTE -TIBURÓN	183
TAPIZ FLOTANTE -TORTUGA	183
TAPIZ GIMNASIA RÍTMICA	257
TAPON NATACION PARA NARIZ	185
TAPON PARA BALONES	281
TAPON PARA TUBOS MUSICALES	96
TAPONES PARA OIDOS	185
TARROS LUPA INSECTOS	63
TESTIGOS ATLETISMO	233
THE HOUSE- LA CASITA MULTICOLOR	53
TIRAS CURVAS CAUCHO	14
TIRAS RECTAS CAUCHO	14
TOBILLERA CASCABEL	98
TORNILLOS Y TUERCAS	26
TRAMPOLIN "OPEN - END"	266

T	P		P
TRAMPOLIN ELASTICO 110x110 CM.	266	VALVULAS PARA BALON	281
TRIANGULOS MUSICALES	100	VARILLA PARA CINTAS RITMICA	248
TRICICLOS	5	VEJIGA PARA PELOTÓN FLOTANTE	69
TRINEO POTENCIADOR DE VELOCIDAD	198	VELCRO AUTOADHESIVO PARA FIG.FOAM	275
TUBOS ENGARZABLES	28	VENTOSAS SUJECION LADRILLO	21
TUBOS MUSICALES	96	VOLANTE BADMINTON PLÁSTICO	225
TUNEL LOCOMOTORA - FUNNY TRAIN	57	VOLANTE BADMINTON VINILO	225
TUNEL REJILLA	59	VOLANTE PARA PALAS DE PADDLE PLAYA	158
TUNEL TREN	57		
TUNELES REDONDOS	58	<b>W</b>	
TURBO TWIST	6	WAVE ROLLER	7
TURNING BOARD- PLATAFORMA DE GIRO	261		
<b>V</b>		<b>X, Y, Z</b>	
VALLA DE GUARDERIA	111	YOYOS	167
VALLA DE GUARDERIA MULTICOLOR	111	ZANCOS BAJOS	56
VALLA ENTRENAMIENTO	196	ZANCOS DE MADERA	56
VALLA SALTO ALUMINIO 0,68-1,06 MT	232	ZANCOS LARGOS	56
VALLA SALTO PLASTICO	232		
VALLA SALTO REGULABLE	232		



**900 995 Bolígrafo solidario (Caja de 40 unidades)**

El importe de la venta de cada bolígrafo es enviado a los proyectos de ACOES en Honduras, donde se mantienen a 7000 niños con total asistencia de comida, ropa y estudios.  
Vea el proyecto en [www.acoes.org](http://www.acoes.org)

Le agradecemos su apoyo.

**Tu ayuda = 1 euro = 1 bolígrafo = 1 sonrisa**

**900 995 Charity pen (40 units box)**

70% of the sale of this pen will be donated to the Foundation ACOES in Honduras where 7.000 children are being totally supported with food, clothing and education.

More info at [www.acoes.org](http://www.acoes.org)

Thank you very much for your commitment.

**Your help = 1 euro = 1 pen = 1 smile**